

The Messenger



No. 175 – Quarter 1 | 2019

The 4MOST Issue:
Overview and Information for the Call for Proposals
Scientific Operations and Survey Strategy Plan
4MOST Consortium Surveys



ESO, the European Southern Observatory, is the foremost intergovernmental astronomy organisation in Europe. It is supported by 16 Member States: Austria, Belgium, the Czech Republic, Denmark, France, Finland, Germany, Ireland, Italy, the Netherlands, Poland, Portugal, Spain, Sweden, Switzerland and the United Kingdom. ESO's programme is focussed on the design, construction and operation of powerful ground-based observing facilities. ESO operates three observatories in Chile: at La Silla, at Paranal, site of the Very Large Telescope, and at Llano de Chajnantor. ESO is the European partner in the Atacama Large Millimeter/submillimeter Array (ALMA). Currently ESO is engaged in the construction of the Extremely Large Telescope.

The Messenger is published, in hardcopy and electronic form, four times a year: in March, June, September and December. ESO produces and distributes a wide variety of media connected to its activities. For further information, including postal subscription to The Messenger, contact the ESO education and Public Outreach Department at:

ESO Headquarters
Karl-Schwarzschild-Straße 2
85748 Garching bei München, Germany
Phone +498932006-0
information@eso.org

The Messenger:
Editors: Gaitee A. J. Hussain,
Anna Miotello; Layout, Typesetting:
Jutta Boxheimer, Mafalda Martins,
Lorenzo Benassi; Graphics: Lorenzo
Benassi; Design, Production: Jutta
Boxheimer; Proofreading: Peter Grimley,
www.eso.org/messenger/

Printed by FIBO Druck- und Verlags GmbH
Fichtenstraße 8, 82061 Neuried, Germany

Unless otherwise indicated, all images in The Messenger are courtesy of ESO, except authored contributions which are courtesy of the respective authors.

© ESO 2019
ISSN 0722-6691

Contents

4MOST

| | |
|--|----|
| de Jong R. S. et al. – 4MOST: Project overview and information for the First Call for Proposals | 3 |
| Walcher C. J. et al. – 4MOST Scientific Operations | 12 |
| Guiglion G. et al. – 4MOST Survey Strategy Plan | 17 |

Surveys

| | |
|--|----|
| Helmi A. et al. – 4MOST Consortium Survey 1: The Milky Way Halo Low-Resolution Survey | 23 |
| Christlieb N. et al. – 4MOST Consortium Survey 2: The Milky Way Halo High-Resolution Survey | 26 |
| Chappini C. et al. – 4MOST Consortium Survey 3: Milky Way Disc and Bulge Low-Resolution Survey (4MIDABLE-LR) | 30 |
| Bensby T. et al. – 4MOST Consortium Survey 4: Milky Way Disc and Bulge High-Resolution Survey (4MIDABLE-HR) | 35 |
| Finoguenov A. et al. – 4MOST Consortium Survey 5: eROSITA Galaxy Cluster Redshift Survey | 39 |
| Merloni A. et al. – 4MOST Consortium Survey 6: Active Galactic Nuclei | 42 |
| Driver S. P. et al. – 4MOST Consortium Survey 7: Wide-Area VISTA Extragalactic Survey (WAVES) | 46 |
| Richard J. et al. – 4MOST Consortium Survey 8: Cosmology Redshift Survey (CRS) | 50 |
| Cioni M.-R. L. et al. – 4MOST Consortium Survey 9: One Thousand and One Magellanic Fields (1001MC) | 54 |
| Swann E. et al. – 4MOST Consortium Survey 10: The Time-Domain Extragalactic Survey (TiDES) | 58 |

Astronomical News

| | |
|--|----|
| ESO Phase 1 Project Team – The New ESO Phase 1 System | 63 |
| Sedaghati E., Miotello A. – Fellows at ESO | 63 |
| Zhang Z.-Y. – External Fellows at ESO | 66 |
| Personnel Movements | 67 |
| Annual Index 2018 (Nos. 171–174) | 69 |

Front cover: The Visible and Infrared Survey Telescope for Astronomy (VISTA) seen here will be converted to the 4-metre Multi Object Spectroscopic Telescope (4MOST) with operations due to start in 2022. Credit: ESO/A. Tudoricá



4MOST: Project overview and information for the First Call for Proposals

Roelof S. de Jong^{1,a}
 Oscar Agertz²
 Alex Agudo Berbel³
 James Aird⁴
 David A. Alexander⁵
 Anish Amarsi⁶
 Friedrich Anders¹
 Rene Andrae⁷
 Behzad Ansarinejad⁵
 Wolfgang Ansorge⁸
 Pierre Antilogus⁹
 Heiko Anwand-Heerwart¹⁰
 Anke Arentsen¹
 Anna Arnadottir²
 Martin Asplund⁶
 Matt Auger⁴
 Nicolas Azais^{1,11}
 Dietrich Baade¹²
 Gabriella Baker¹³
 Sufyan Baker¹³
 Eduardo Balbinot¹⁴
 Ivan K. Baldry¹⁵
 Manda Banerji⁴
 Samuel Barden¹
 Paul Barklem¹⁶
 Eléonore Barthélémy-Mazot¹⁷
 Chiara Battistini¹⁸
 Svend Bauer¹
 Cameron P. M. Bell¹
 Olga Bellido-Tirado¹
 Sabine Bellstedt¹⁹
 Vasily Belokurov⁴
 Thomas Bensby²
 Maria Bergemann⁷
 Joachim M. Bestenlehner²⁰
 Richard Bielby⁵
 Maciej Bilicki²¹
 Chris Blake²²
 Joss Bland-Hawthorn²³
 Corrado Boeche²⁴
 Wilfried Boland^{25,21}
 Thomas Boller³
 Sebastien Bongard⁹
 Angela Bongiorno²⁶
 Piercarlo Bonifacio²⁷
 Didier Boudon²⁸
 David Brooks²⁹
 Michael J. I. Brown³⁰
 Rebecca Brown¹³
 Marcus Brüggen³¹
 Joar Brynnel¹
 Jurek Brzeski¹³
 Thomas Buchert²⁸
 Peter Buschkamp¹⁸
 Elisabetta Caffau²⁷
 Patrick Caillier²⁸
 Jonathan Carrick³²
 Luca Casagrande⁶
 Scott Case¹³
 Andrew Casey³⁰
 Isabella Cesarini¹
 Gabriele Cescutti³³
 Diane Chapuis²⁸
 Cristina Chiappini¹
 Michael Childress³⁴
 Norbert Christlieb¹⁸
 Ross Church²
 Maria-Rosa L. Cioni¹
 Michelle Cluver²²
 Matthew Colless⁶
 Thomas Collett³⁵
 Johan Comparat³
 Andrew Cooper⁵
 Warrick Couch^{36,22}
 Frederic Courbin³⁷
 Scott Croom²³
 Darren Croton²²
 Eric Daguisé²⁸
 Gavin Dalton³⁸
 Luke J. M. Davies¹⁹
 Tamara Davis³⁹
 Patrick de Laverny⁴⁰
 Alis Deason⁵
 Frank Dionies¹
 Karen Disseau²⁸
 Peter Doel²⁹
 Daniel Döscher¹
 Simon P. Driver¹⁹
 Tom Dwelly³
 Dominique Eckert³
 Alastair Edge⁵
 Bengt Edvardsson¹⁶
 Dalal El Youssoufi¹
 Ahmed Elhaddad¹⁸
 Harry Enke¹
 Ghazaleh Erfanianfar³
 Tony Farrell¹³
 Thomas Fechner¹
 Carmen Feiz¹⁸
 Sofia Feltzing²
 Ignacio Ferreras²⁹
 Dietrich Feuerstein¹
 Diane Feuillet⁷
 Alexis Finoguenov^{3,41}
 Dominic Ford²
 Sotiria Fotopoulou⁵
 Morgan Fouesneau⁷
 Carlos Frenk⁵
 Steffen Frey¹
 Wolfgang Gaessler⁷
 Stephan Geier⁴²
 Nicola Gentile Fusillo⁴³
 Ortwin Gerhard³
 Tommaso Giannantonio⁴
 Domenico Giannone¹
 Brad Gibson⁴⁴
 Peter Gillingham¹³
 Carlos González-Fernández⁴
 Eduardo Gonzalez-Solares⁴
 Stefan Gottloeber¹
 Andrew Gould^{45,7}
 Eva K. Grebel²⁴
 Alain Gueguen³
 Guillaume Guiglion¹
 Martin Haehnelt⁴
 Thomas Hahn¹
 Camilla J. Hansen^{7,46}
 Henrik Hartman²
 Katja Hauptner¹⁰
 Keith Hawkins⁴
 Dionne Haynes¹
 Roger Haynes¹
 Ulrike Heiter¹⁶
 Amina Helmi¹⁴
 Cesar Hernandez Aguayo⁵
 Paul Hewett⁴
 Samuel Hinton³⁹
 David Hobbs²
 Sebastian Hoenig³⁴
 David Hofman¹⁷
 Isobel Hook³²
 Joshua Hopgood¹²
 Andrew Hopkins¹³
 Anna Hourihane⁴
 Louise Howes²
 Cullan Howlett¹⁹
 Tristan Huet¹
 Mike Irwin⁴
 Olaf Iwert¹²
 Pascale Jablonka³⁷
 Thomas Jahn¹
 Knud Jahnke⁷
 Aurélien Jarno²⁸
 Shoko Jin¹⁴
 Paula Jofre⁴
 Diana Johl¹
 Damien Jones⁴⁷
 Henrik Jönsson²
 Carola Jordan⁷
 Iva Karovicova¹⁸
 Arman Khalatyan¹
 Andreas Kelz¹
 Robert Kennicutt⁴
 David King⁴
 Francisco Kitaura⁴⁸
 Jochen Klar¹
 Urs Klauser¹³
 Jean-Paul Kneib³⁷
 Andreas Koch²⁴
 Sergey Kopusov⁴
 Georges Kordopatis⁴⁰
 Andreas Korn¹⁶
 Johan Kosmalski^{12,28}
 Rubina Kotak^{49,50}
 Mikhail Kovalev⁷
 Kathryn Kreckel⁷
 Yevgen Kripak¹³

Mirko Krumpe¹
 Koen Kuijken²¹
 Andrea Kunder¹
 Iryna Kushniruk²
 Man I Lam¹
 Georg Lamer¹
 Florence Laurent²⁸
 Jon Lawrence¹³
 Michael Lehmitz⁷
 Bertrand Lemasle²⁴
 James Lewis⁴
 Baojiu Li⁵
 Chris Lidman^{36,6}
 Karin Lind¹⁶
 Jochen Liske³¹
 Jean-Louis Lizon¹²
 Jon Loveday⁵¹
 Hans-Günter Ludwig¹⁸
 Richard M. McDermid⁵²
 Kate Maguire⁴⁹
 Vincenzo Mainieri¹²
 Slavko Mali¹³
 Holger Mandel¹⁸
 Kaisey Mandel⁴
 Liz Mannering^{36,19}
 Sarah Martell⁵³
 David Martinez Delgado²⁴
 Gal Matijevic¹
 Helen McGregor¹³
 Richard McMahan⁴
 Paul McMillan²
 Olga Mena⁵⁴
 Andrea Merloni³
 Martin J. Meyer¹⁹
 Christophe Michel¹⁷
 Genoveva Micheva¹
 Jean-Emmanuel Migniau²⁸
 Ivan Minchev¹
 Giacomo Monari¹
 Rolf Müller¹³
 David Murphy⁴
 Daniel Muthukrishna⁴
 Kirpal Nandra³
 Ramon Navarro⁵⁵
 Melissa Ness⁷
 Vijay Nichani¹³
 Robert Nichol³⁵
 Harald Nicklas¹⁰
 Florian Niederhofer¹
 Peder Norberg⁵
 Danail Obreschkow¹⁹
 Seb Oliver⁵¹
 Matt Owers⁵²
 Naveen Pai¹³
 Sergei Pankratov¹
 David Parkinson³⁹
 Jens Paschke¹
 Robert Paterson¹³
 Arlette Pecontal²⁸

Ian Parry⁴
 Dan Phillips¹
 Annalisa Pillepich⁷
 Laurent Pinard¹⁷
 Jeff Pirard¹²
 Nikolai Piskunov¹⁶
 Volker Plank¹
 Dennis Plüschke¹
 Estelle Pons⁴
 Paola Popesso⁵⁶
 Chris Power¹⁹
 Johan Pragt⁵⁵
 Alexander Pramskiy¹⁸
 Dan Pryer⁵¹
 Marco Quattri¹²
 Anna Barbara de Andrade Queiroz¹
 Andreas Quirrenbach¹⁸
 Swara Rahurkar¹
 Anand Raichoor³⁷
 Sofia Ramstedt¹⁶
 Arne Rau³
 Alejandra Recio-Blanco⁴⁰
 Roland Reiss¹²
 Florent Renaud²
 Yves Revaz³⁷
 Petra Rhode¹⁰
 Johan Richard²⁸
 Amon David Richter¹⁰
 Hans-Walter Rix⁷
 Aaron S. G. Robotham¹⁹
 Ronald Roelfsema^{57,55}
 Martino Romaniello¹²
 David Rosario⁵
 Florian Rothmaier¹⁸
 Boudewijn Roukema^{58,28}
 Gregory Ruchti²
 Gero Rupprecht¹²
 Jan Rybizki⁷
 Nils Ryde²
 Andre Saar¹
 Elaine Sadler²³
 Martin Sahlén¹⁶
 Mara Salvato³
 Benoît Sassolas¹⁷
 Will Saunders¹³
 Allar Saviauk¹
 Luca Sbordone⁵⁹
 Thomas Schmidt¹
 Olivier Schnurr^{1,60}
 Ralf-Dieter Scholz¹
 Axel Schwope¹
 Walter Seifert¹⁸
 Tom Shanks⁵
 Andrew Sheinis^{36,61}
 Tihomir Sivov¹
 Ása Skúladóttir⁷
 Stephen Smartt⁴⁹
 Scott Smedley¹³
 Greg Smith¹

Robert Smith⁵¹
 Jenny Sorce^{28,1}
 Lee Spitler⁵²
 Else Starckenburg¹
 Matthias Steinmetz¹
 Ingo Stiliz¹⁸
 Jesper Storm¹
 Mark Sullivan³⁴
 William Sutherland⁶²
 Elizabeth Swann³⁵
 Amélie Tamone³⁷
 Edward N. Taylor²²
 Julien Teillon¹⁷
 Elmo Tempel^{63,1}
 Rik ter Horst⁵⁵
 Wing-Fai Thi³
 Eline Tolstoy¹⁴
 Scott Trager¹⁴
 Gregor Traven²
 Pier-Emmanuel Tremblay⁴³
 Laurence Tresse²⁸
 Marica Valentini¹
 Rien van de Weygaert¹⁴
 Mario van den Ancker¹²
 Jovan Veljanoski¹⁴
 Sudharshan Venkatesan¹³
 Lukas Wagner¹
 Karl Wagner¹⁸
 C. Jakob Walcher¹
 Lew Waller¹³
 Nicholas Walton⁴
 Lingyu Wang^{57,14}
 Roland Winkler¹
 Lutz Wisotzki¹
 C. Clare Worley⁴
 Gabor Worsecck⁴²
 Maosheng Xiang⁷
 Wenli Xu⁶⁴
 David Yong⁶
 Cheng Zhao³⁷
 Jessica Zheng¹³
 Florian Zscheyge¹
 Daniel Zucker⁵²

¹ Leibniz-Institut für Astrophysik Potsdam (AIP), Germany

² Lund Observatory, Lund University, Sweden

³ Max-Planck-Institut für extraterrestrische Physik, Garching, Germany

⁴ Institute of Astronomy, University of Cambridge, UK

⁵ Department of Physics, Durham University, UK

⁶ Research School of Astronomy & Astrophysics, Australian National University, Canberra, Australia

- ⁷ Max-Planck-Institut für Astronomie, Heidelberg, Germany
- ⁸ RAMS-CON, Assling, Germany
- ⁹ Laboratoire de physique nucléaire et de hautes énergies, Paris, France
- ¹⁰ Institut für Astrophysik, Georg-August Universität Göttingen, Germany
- ¹¹ IRIDESCENCE, Paris, France
- ¹² ESO
- ¹³ Australian Astronomical Optics — Macquarie, Sydney, Australia
- ¹⁴ Kapteyn Instituut, Rijksuniversiteit Groningen, the Netherlands
- ¹⁵ Astrophysics Research Institute, Liverpool John Moores University, UK
- ¹⁶ Department of Physics and Astronomy, Uppsala universitet, Sweden
- ¹⁷ Laboratoire des Matériaux Avancés, Lyon, France
- ¹⁸ Zentrum für Astronomie der Universität Heidelberg/Landessternwarte, Germany
- ¹⁹ International Centre for Radio Astronomy Research/University of Western Australia, Perth, Australia
- ²⁰ Physics and Astronomy, University of Sheffield, UK
- ²¹ Sterrewacht Leiden, Universiteit Leiden, the Netherlands
- ²² Centre for Astrophysics and Supercomputing, Swinburne University of Technology, Hawthorn, Australia
- ²³ Sydney Institute for Astronomy, University of Sydney, Australia
- ²⁴ Zentrum für Astronomie der Universität Heidelberg/Astronomisches Recheninstitut, Germany
- ²⁵ Nederlandse Onderzoekschool Voor Astronomie (NOVA), Leiden, the Netherlands
- ²⁶ Osservatorio Astronomico di Roma, INAF, Italy
- ²⁷ GEPI, Observatoire de Paris, Université PSL, CNRS, France
- ²⁸ Centre de Recherche Astrophysique de Lyon, France
- ²⁹ Department of Physics and Astronomy, University College London, UK
- ³⁰ School of Physics and Astronomy, Monash University, Melbourne, Australia
- ³¹ Hamburger Sternwarte, Universität Hamburg, Germany
- ³² Physics Department, Lancaster University, UK
- ³³ Osservatorio Astronomico di Trieste, INAF, Italy
- ³⁴ School of Physics and Astronomy, University of Southampton, UK
- ³⁵ Institute of Cosmology and Gravitation, University of Portsmouth, UK
- ³⁶ Australian Astronomical Observatory, Sydney, Australia
- ³⁷ Laboratoire d'astrophysique, École Polytechnique Fédérale de Lausanne, Switzerland
- ³⁸ Department of Physics, University of Oxford, UK
- ³⁹ School of Mathematics and Physics, University of Queensland, Brisbane, Australia
- ⁴⁰ Observatoire de la Côte d'Azur, Nice, France
- ⁴¹ University of Helsinki, Finland
- ⁴² Institut für Physik und Astronomie, Universität Potsdam, Germany
- ⁴³ Department of Physics, University of Warwick, UK
- ⁴⁴ E. A. Milne Centre for Astrophysics, University of Hull, UK
- ⁴⁵ Ohio State University, Columbus, USA
- ⁴⁶ Dark Cosmology Centre, Københavns Universitet, Denmark
- ⁴⁷ Prime Optics, Eumundi, Queensland, Australia
- ⁴⁸ Instituto de Astrofísica de Canarias, La Laguna, Tenerife, Spain
- ⁴⁹ School of Mathematics and Physics, Queen's University Belfast, UK
- ⁵⁰ University of Turku, Finland
- ⁵¹ University of Sussex, Brighton, UK
- ⁵² Department of Physics and Astronomy, Macquarie University, Sydney, Australia
- ⁵³ School of Physics, University of New South Wales, Sydney, Australia
- ⁵⁴ Instituto de Física Corpuscular, Universidad de Valencia, Spain
- ⁵⁵ Nederlandse Onderzoekschool Voor Astronomie (NOVA), Dwingeloo, the Netherlands
- ⁵⁶ Physics Department, Technische Universität München, Germany
- ⁵⁷ Netherlands Institute for Space Research (SRON), Groningen, the Netherlands
- ⁵⁸ Torun Centre for Astronomy (TCfA), Nicolaus Copernicus University, Poland
- ⁵⁹ Pontificia Universidad Católica de Chile, Santiago, Chile
- ⁶⁰ Cherenkov Telescope Array Observatory, Bologna, Italy
- ⁶¹ CFHT, Kamuela, Hawaii, USA
- ⁶² School of Physics and Astronomy, Queen Mary University of London, UK
- ⁶³ Tartu Observatory, University of Tartu, Estonia
- ⁶⁴ XU-OSE, Heidelberg, Germany

We introduce the 4-metre Multi-Object Spectroscopic Telescope (4MOST), a new high-multiplex, wide-field spectroscopic survey facility under development for the four-metre-class Visible and Infrared Survey Telescope for Astronomy (VISTA) at Paranal. Its key specifications are: a large field of view (FoV) of 4.2 square degrees and a high multiplex capability, with 1624 fibres feeding two low-resolution spectrographs ($R = \lambda/\Delta\lambda \sim 6500$), and 812 fibres transferring light to the high-resolution spectrograph ($R \sim 20\,000$). After a description of the instrument and its expected performance, a short overview is given of its operational scheme and planned 4MOST Consortium science; these aspects are covered in more detail in other articles in this edition of *The Messenger*. Finally, the processes, schedules, and policies concerning the selection of ESO Community Surveys are presented, commencing with a singular opportunity to submit Letters of Intent for Public Surveys during the first five years of 4MOST operations.

4MOST is being developed to address a broad range of pressing scientific questions in the fields of Galactic archaeology, high-energy astrophysics, galaxy evolution and cosmology. Its design allows tens of millions of spectra to be obtained via five-year surveys, even for targets distributed over a significant fraction of the sky. While many science cases can be addressed with 4MOST, its primary purpose is to provide the spectroscopic complements to large-area surveys coming from key European space missions like eROSITA and the ESA Gaia, Euclid and PLATO missions, as well as from ground-based facilities like VISTA, the VLT Survey Telescope (VST), the Dark Energy Survey (DES), the Large Synoptic Survey Telescope (LSST) and the Square Kilometre Array (SKA).

Multiple science cases must be carried out simultaneously in order to efficiently fill all the fibres in a high multiplex instrument like 4MOST. This necessitates effective coordination between different science teams. To enable this, the 4MOST Consortium will perform Public Surveys using 70% of the available fibre-hours in the first five years of operation.

These Public Surveys are Guaranteed Time Observations (GTO) that the Consortium receives in return for building the facility and for supporting ESO in the operation of 4MOST. Public Surveys of the ESO and the Chilean host country communities will fill the other 30% of available fibre-hours in the first five years of operation. These surveys will be chosen by a one-time, competitive, peer-reviewed selection process, similarly to other ESO Calls for Public Surveys. Here, a fibre-hour is defined as one hour of observing time, including overheads, with one fibre; hence 4MOST offers 2436 fibre-hours every hour that it is observing.

Following this overview, which contains information on instrument performance and on the procedures associated with the use of 4MOST by the community, this issue of *The Messenger* includes additional articles on the 4MOST science operations model, the survey plan of the 4MOST Consortium, and a description of the ten Public Surveys that the Consortium intends to carry out. Together these articles are intended to prepare the ESO community for the proposal process that will commence in the second half of 2019. The process will start with a one-off opportunity for the submission of Letters of Intent to apply for Public Surveys to be executed during the first five years of 4MOST operation.

Organisation

The 4MOST project is organised along three branches:

1. Instrument — responsible for the development, construction, and commissioning of the instrument hardware and associated software;
 2. Operations — for the planning, data reduction, archiving, and publishing of the observations including the associated data-flow;
 3. Science — the branch that develops the different Surveys and is responsible for science analysis and publication.
- The instrument and operations branches are mainly performed by the 4MOST Consortium and are jointly called the 4MOST Facility.

Table 1. 4MOST key instrument specifications.

| Instrument parameter | Design value |
|--|--|
| Field of view (hexagon) | ~ 4.2 square degrees ($\varnothing = 2.6$ degrees) |
| Accessible sky (zenith angle < 55 degrees) | > 30 000 square degrees |
| Expected on-target fibre-hours per year | LRS: > 3 200 000 h yr ⁻¹ , HRS > 1 600 000 h yr ⁻¹ |
| Multiplex fibre positioner | 2436 |
| Low-Resolution Spectrographs LRS (x 2) | |
| Resolution | $\langle R \rangle = 6500$ |
| Number of fibres | 812 fibres |
| Passband | 3700–9500 Å |
| Velocity accuracy | < 1 km s ⁻¹ |
| Mean sensitivity 6 × 20 min, mean seeing, new moon, S/N = 10 Å ⁻¹ (AB-magnitude) | 4000 Å: 20.2, 5000 Å: 20.4, 6000 Å: 20.4, 7000 Å: 20.2, 8000 Å: 20.2, 9000 Å: 19.8 |
| High-Resolution Spectrograph HRS (x 1) | |
| Resolution | $\langle R \rangle = 20\,000$ |
| Number of fibres | 812 fibres |
| Passband | 3926–4355, 5160–5730, 6100–6790 Å |
| Velocity accuracy | < 1 km s ⁻¹ |
| Mean sensitivity 6 × 20 min, mean seeing, 80% moon, S/N = 100 Å ⁻¹ (AB-magnitude) | 4200 Å: 15.7, 5400 Å: 15.8, 6500 Å: 15.8 |
| Smallest target separation | 15 arcseconds on any side |
| # of fibres in random $\varnothing = 2$ arcminute circle | ≥ 3 |
| Fibre diameter | $\varnothing = 1.45$ arcseconds |

The instrument is under construction at a number of Consortium institutes, coordinated by the 4MOST Project Office located at the Leibniz-Institut für Astrophysik Potsdam (AIP). Once the subsystems are finished at the different institutes, they will all be transported to Potsdam and extensively tested there as a full system before being shipped to Paranal. At Paranal the 4MOST instrument will be installed, tested, and commissioned on the VISTA telescope.

The operations branch is led by the Operations Development Group, consisting of the leads of the different subsystems and working groups involved in observation planning and data-flow. It also contains the 4MOST Helpdesk activities.

The science programme is organised into several surveys. The members of the survey teams are spread over all participating institutes and each team is led by one or more Survey Principal Investigators (Survey PIs). Coordination between all participating surveys is performed by the Science Coordination Board (SCB), consisting of all Survey PIs. The science branch is overseen by two Project Scientists, one for Galactic and one for extragalactic science, who have both a science guidance and a managerial role.

Instrument

The 4MOST instrument design was driven by the science requirements of its key Consortium Surveys. Within a 2-hour observation 4MOST has the sensitivity to obtain redshifts of $r = 22.5$ magnitudes (AB) galaxies and active galactic nuclei (AGN), radial velocities of any Gaia source ($G < 20.5$ magnitudes [Vega]), stellar parameters and selected key elemental abundances with accuracy better than 0.15 dex of $G < 18$ -magnitude stars, and abundances of up to 15 elements of $G < 15.5$ -magnitude stars. Furthermore, in a five-year survey 4MOST can cover > 17 000 square degrees at least twice and obtain spectra of more than 20 million sources with a resolution of $R \sim 6500$ and more than three million spectra with a resolution of $R \sim 20\,000$ for the typical science cases proposed. The main instrument parameters enabling these science requirements are summarised in Table 1.

Figure 1 provides an overview of the main instrument subsystems. A new Wide Field Corrector (WFC) equipped with an Atmospheric Dispersion Compensator (ADC) that provides corrections to a 55-degree zenith angle distance creates a focal surface with a 2.6-degree diameter. Two Acquisition and Guiding (A&G) cameras ensure correct pointing, while four

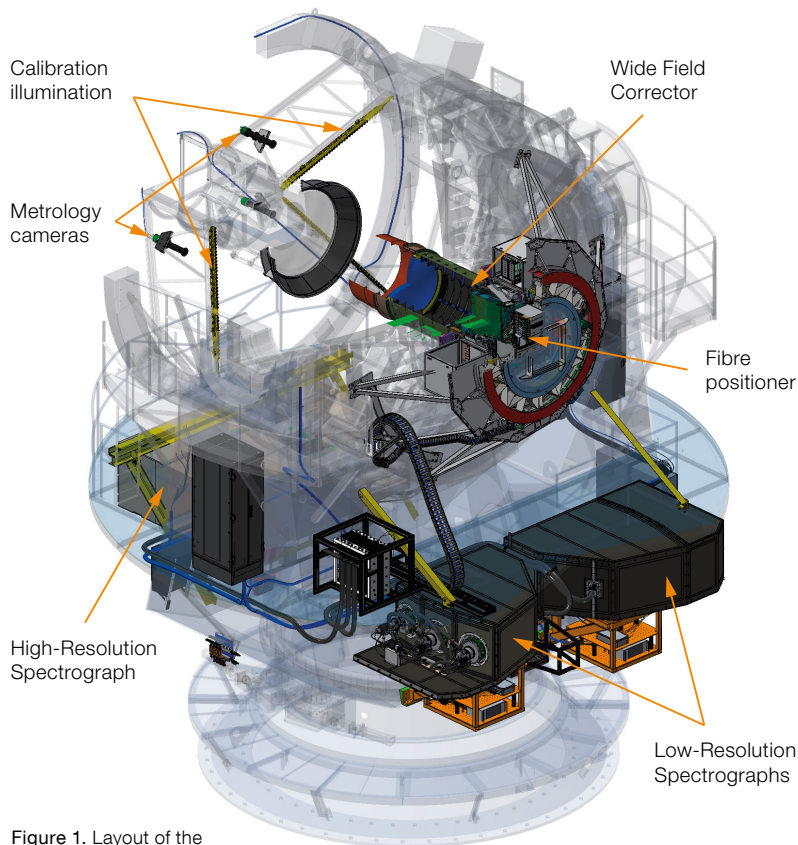

Figure 1. Layout of the different subsystems of 4MOST on the VISTA telescope.

Wave Front Sensing (WFS) cameras steer the active optics system of the telescope.

The AESOP fibre positioning system based on the tilting spine principle can, within 2 minutes, simultaneously position all of the 2436 science fibres that are arranged in a hexagonally shaped grid at the focal surface. The accuracy of fibre positioning is expected to be better than 0.2 arcseconds thanks to a four-camera metrology system observing the fibre tips back-illuminated from the spectrograph. The tilting spine positioner has the advantage that each fibre has a large patrol area; each target in the science field of view can be reached by at least three fibres that go to one of the Low-Resolution Spectrographs (LRS) and one or two fibres that go to the High-Resolution Spectrograph (HRS). This ensures a high allocation efficiency of the fibres to targets, even when targets are clustered.

Each spectrograph accepts 812 science fibres and six simultaneous calibration

fibres attached to either end of the spectrograph entrance slit. The covered wavelength range and resolution of the LRS and HRS spectrographs are as listed in Table 1 and depicted in Figure 2. Each type of spectrograph has three channels in fixed configurations covering three wavelength bands, and is thermally invariant and insulated (HRS) or temperature controlled (LRS) for stability. Each channel is equipped with a $6\text{ k} \times 6\text{ k}$ CCD detector with low read noise (< 2.3 electrons per read) and with high, broadband quantum efficiency. The spectra are sampled with about three pixels per resolution element.

A calibration system equipped with a continuum source, a Fabry-Perot etalon, and ThAr lamps can feed light through the telescope plus science fibres combination and also directly through the simultaneous calibration fibres into the spectrograph slit to ensure accurate wavelength calibration. This will ensure that we can typically reach better than

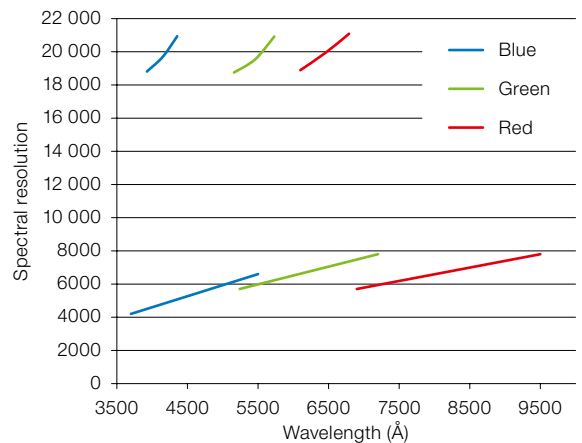

Figure 2. Spectral resolution in the three channels of the 4MOST High-Resolution (HRS, upper lines) and Low-Resolution Spectrographs (LRS; lower lines).

1 km s^{-1} accuracy on stellar radial velocities. The expected sensitivity is depicted in Figure 3. The estimated observing overheads are currently conservatively estimated to be 3.5 minutes per repositioning of the telescope and 4.4 minutes per science exposure for repositioning of the fibres, obtaining attached calibration frames, and performing detector readout. We aim to reduce these overhead numbers in the future by executing more exposure setup activities in parallel and by reducing the number of attached night-time calibration exposures once we have established the stability and calibration reproducibility of the full system.

Operations

The 4MOST operations scheme differs from other ESO instrument operations in that it allows many different science cases to be scheduled simultaneously during one observation. To accommodate the range of exposure times required for different targets, the same part of the sky will be observed with multiple exposures and visits. Objects that require longer exposures will be exposed several times until their stacked spectra reach the required signal-to-noise. 4MOST operations also differ from the standard ESO scheme in that the 4MOST Consortium plays a primary role in planning the observations (Phase 2) and in reducing, analysing and publishing the data (Phase 3).

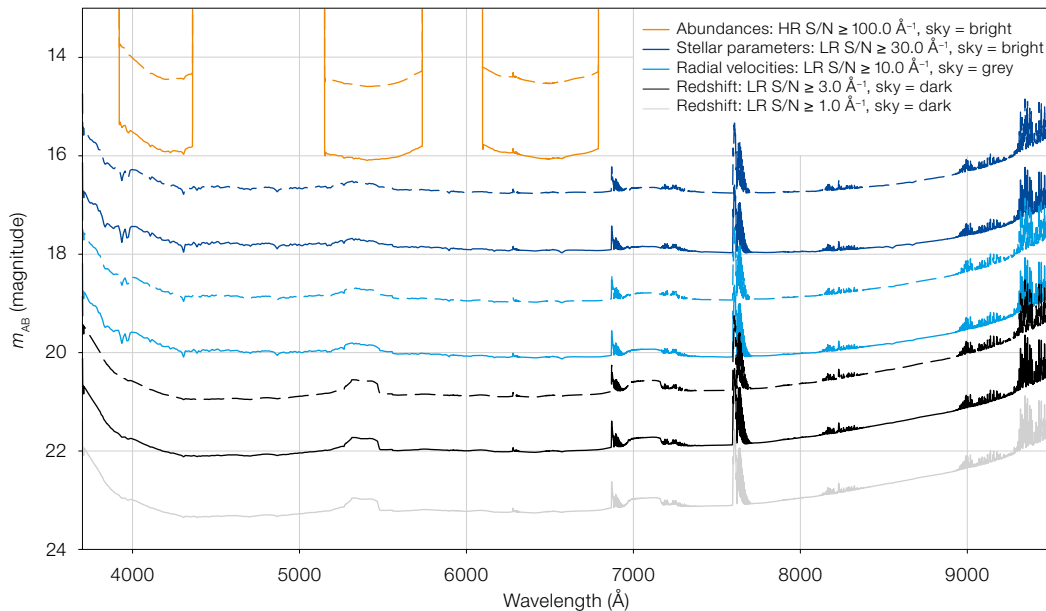

Figure 3. The expected 4MOST point-source sensitivities for the signal-to-noise levels and lunar conditions indicated in the legend. The solid lines are for a total exposure time of 120 minutes, whereas the dashed lines are the limits for 20-minute exposures. The approximate conversion to signal-to-noise per pixel is obtained by dividing the HRS values by 3.3 and the LRS values by 1.7. For clarity, sky emission lines are removed — this mostly affects results redward of 7000 Å. Mean (not median) seeing conditions, airmass values, fibre quality and positioning errors, etc., are used, in order to ensure that this plot is representative for an entire 4MOST survey, not just for the optimal conditions. Typical science cases for obtaining detailed elemental abundances of stars (orange), stellar parameters and some elemental abundances (dark blue), stellar radial velocities (light blue), and galaxy and AGN redshifts (black: 90% complete, grey: 50% complete) are shown.

These Consortium activities are closely monitored by ESO to ensure uniform progress and data quality for all surveys. The details of 4MOST operations are described in the accompanying article in this edition of *The Messenger* (Walcher et al., p. 12).

Science

The 4MOST science programme formulated by the Consortium has been organised into the ten surveys listed in Table 2. There are five surveys centred on stellar objects to perform Galactic archaeology of different components of the Milky Way and the Magellanic Clouds, with the goal of understanding their current structure and their assembly history. There are four surveys of extragalactic objects aiming to characterise cosmological parameters, the nature of dark energy and dark matter, and the formation history of galaxies and black holes. Finally, there is a survey dedicated to time domain discoveries, mainly in synergy with the LSST facility where supernova transients and quasar luminosity variations will be complemented with spectroscopic observations.

For most of these surveys, millions of spectra will be obtained, having a huge legacy value for the community and creating an enormous potential for serendipitous discoveries. Being the only facil-

ity in the south with such a large field of view and multiplex capability creates numerous unique opportunities for 4MOST. Of special interest are synergies with new southern hemisphere facilities under construction such as LSST, SKA, and ESO’s ELT. The southern sky is of particular interest for Galactic archaeology, with good access to the Milky Way bulge and the Magellanic Clouds. For this science, the $R \sim 20\,000$ of the HRS enables accurate abundance measurements of many elements; the $R \sim 6500$ LRS spectra also have higher spectral resolution and better sampling of the spectral resolution elements than similar high-multiplex, wide-field facilities, thereby allowing better stellar elemental abundance determinations. 4MOST provides an unprecedentedly large volume coverage of all Galactic components, thereby expanding on the legacy of the ESA Gaia mission.

This *Messenger* edition contains sufficiently detailed descriptions of the Consortium Surveys and the overall observing strategy (Guiglion et al., p. 17) to enable the ESO community to develop complementary surveys using the roughly 4.8/2.4 million LRS/HRS fibre-hours available to them in the first 5-year survey. The process of integrating community observing programmes into the 4MOST survey programme is described in the next section.

Community programmes

In designing the 4MOST operations system, the aim has been to follow normal ESO operations as much as possible. This means that 4MOST follows the ESO Public Surveys sequence of programme selection (Phase 1), observation preparation (Phase 2), programme execution at the telescope, and finally data reduction, analysis, and publication (Phase 3). However, 4MOST, being a survey facility running typically many science programmes simultaneously in each observation, has required some modifications to the normal process, as described below.

As highlighted earlier, 4MOST Surveys have a duration of five years. This ensures that large projects can be accomplished with carefully crafted completeness goals and well understood selection functions. New programmes will be selected and started only once every five years and, after a short run-in period, the observing strategy will stay as stable as possible during each five-year survey programme. All surveys on 4MOST will be Public Surveys, which means that the raw data will be published immediately in the ESO archive and that the science teams of the surveys have an obligation to release higher-level data products that have legacy value for the community.

Table 2. 4MOST Consortium Surveys and their Principal Investigators.

| No | Survey Name | Survey (Co-)PI |
|-----|--|---------------------------------------|
| S1 | Milky Way Halo LR Survey | Irwin (IoA), Helmi (RuG) |
| S2 | Milky Way Halo HR Survey | Christlieb (ZAH) |
| S3 | Milky Way Disc and Bulge LR Survey (4MIDABLE LR) | Chiappini, Minchev, Starkenburg (AIP) |
| S4 | Milky Way Disc and Bulge HR Survey (4MIDABLE HR) | Bensby (Lund), Bergemann (MPIA) |
| S5 | Galaxy Clusters Survey | Finoguenov (MPE) |
| S6 | AGN Survey | Merloni (MPE) |
| S7 | Galaxy Evolution Survey (WAVES) | Driver (UWA), Liske (UHH) |
| S8 | Cosmology Redshift Survey | Richard (CRAL), Kneib (EPFL) |
| S9 | Magellanic Clouds Survey (1001MC) | Cioni (AIP) |
| S10 | Time-Domain Extragalactic Survey (TIDES) | Sullivan (Southampton) |

The community can propose for one of two types of Survey programmes with 4MOST.

1) Participating Surveys from the ESO community will join the Consortium Surveys in a common observing programme, where they share the available fibres in each observing block and are “charged” fibre-hours only for their fraction of fibres used. They also share the time spent on any duplicate targets in common between surveys, get full access to all data from the Consortium and participating community programmes, and are invited to collaborate in the higher-level data analysis and publication efforts.

2) Non-Participating Surveys get their own (half) nights on the telescope and will be “charged” fibre-hours for the full 2436 fibres during that time regardless of whether they can all be filled. These surveys will receive calibrated and extracted spectra from the Consortium data management system, but will not have access to any data other than their own and they will be responsible for delivering higher-level data products to the ESO archive on their own. While many aspects are the same for Participating and Non-Participating Surveys, critical differences during the various execution phases of the Surveys are highlighted below.

Phase 1

4MOST Phase 1 will begin with a Call for Letters of Intent. Each Letter of Intent is expected to set out: the science goals of the proposed survey; a description of its scope (for example, the number of targets and their distribution on the sky, the targets’ luminosity range, the approxi-

mate number of fibre-hours needed); an initial list of Survey team members and their roles (i.e., a simple management plan); and whether the proposal is for a Participating or Non-Participating Survey. To estimate the feasibility and scope of the observations an Exposure Time Calculator (ETC) will be provided through an ESO web interface for single targets, and through an ETC tool from the 4MOST Consortium for many targets at once. After a peer review of the Letters of Intent that will be managed by ESO, a number of teams will be invited to respond to the 4MOST Call for Proposals, at which time ESO may suggest that some of the community proposals merge with other community or Consortium proposals.

At this stage a more detailed science case will be required as well as a full (mock) target catalogue with template spectra, spectral success criteria, and a total survey goal encapsulated by a figure of merit. A web-based version of the 4MOST Facility Simulator (4FS) will be provided, allowing proposers to check the feasibility of their proposed survey. 4FS will provide an estimate of the number of successfully observed targets in a five-year survey when run either stand-alone (Non-Participating proposals) or in conjunction with the Consortium Surveys (Participating proposals) and the required number of fibre-hours. Clearly, proposals that are well matched to the overall observing strategy of 4MOST as described in the 4MOST Survey Plan article in this edition (for example, surveys with sparsely distributed targets or with looser completeness requirements) have a higher chance of being successfully executed in the amount of time available.

After selection of all Consortium and Community Surveys through ESO’s peer review process for Public Surveys proposals, the selected programmes will be invited to submit survey management plans, approval of which by the ESO Director General is mandatory before the final acceptance of a Public Survey. The survey management plan will contain a detailed list of science data products and timeline for their release. For Consortium and Participating Community Surveys a single, joint survey management plan will be delivered. For Non-Participating Community Surveys, each Survey PI will be responsible for the delivery of a survey management plan.

Phase 2

After selection, the members of the Participating Community Surveys will join the Consortium Surveys to form the joint Science Team. The Community Survey PIs will become members of the Science Coordination Board and it is expected that the Community Surveys will provide staff effort to the different 4MOST working groups, most notably those on survey strategy, selection functions, quality assurance, and, if they so wish, higher-level pipelines. The target catalogues of the Community Surveys will be merged with those of the Consortium and through an iterative process a joint survey plan will be developed to observe all targets. Once the final observing strategy has been agreed upon, only small changes in strategy will be allowed during the operations phase without approval by the SCB and/or ESO. The 4MOST Operations Group provided by the Consortium will create all Observing Blocks running on 4MOST.

Non-Participating Surveys will not join the Science Team, but will be provided with software to create and submit their own Observing Blocks which will be scheduled on their assigned (half) nights. Any significant changes from the original Non-Participating Survey plan will have to be approved by ESO.

Phase 3

As with ESO’s Public Survey policies, 4MOST Survey programmes have data delivery obligations to ESO and its community. All 4MOST raw data will become available as soon as they have been

ingested into the ESO archive at the end of each night. The raw data will be processed by the Consortium Data Management System to remove instrumental effects and create one-dimensional, flux- and wavelength-calibrated Level 1 (L1) spectra. The L1 data will be released yearly through the ESO archive. For Participating Surveys, dedicated classification, stellar and extragalactic pipelines run by Consortium working groups will produce Level 2 (L2) data products like object type likelihoods, stellar parameters, elemental abundances and redshifts, etc. These products will be released through the ESO archive on a schedule to be agreed upon with ESO before the start of the observations. All L1 and L2 products will also be released through the 4MOST World Archive operated by the Consortium, which will also contain matched catalogues from other facilities and added value catalogues with data processed beyond the standard pipelines. While the Consortium will take care of uploading the L1 and L2 products to the ESO archive for the joint Science Team, Non-Participating Surveys will have to produce and upload their own L2 products to ESO.

Policies

Given the joint use of the available fibres and the corresponding mixed nature of the data products, members of the Consortium Surveys and Participating Community Surveys, i.e., members of the joint Science Team, have to abide by a number of policies to ensure fair use of data and a fair return on investment. Community Survey membership will be limited to those on the original proposal plus up to 15 additional members added at a later stage if a certain capability or expertise is needed that is not available within the Science Team. Participating Community Survey targets may overlap by a maximum of 20% with Consortium targets, but will share the required “cost” in exposure time for the overlap, allowing both surveys to do more in their allotted amount of fibre-hours. All data products are shared among all Science Team members. However, all science exploitation shall take place in projects announced to the whole Science Team and restrictions regarding this exploitation may be applied when a new project overlaps significantly with an existing PhD project or with the core science of a Survey that the project proposer is not a member of. Full details of these Science Team policies as approved by ESO will be released along-

side a Code of Conduct when the Call for Letters of Intent is published. By submitting a Participating Survey programme the proposers implicitly agree to comply with these policies.

For Non-Participating Surveys there may be at most a 30% overlap in targets with other Surveys and they will not share exposure time with other Surveys. This means that any duplicate targets in Non-Participating Surveys will be observed twice as there is no means to coordinate the effort with other Surveys. Non-Participating Surveys are free to devise their own membership, data access, and publication policies.

Further information

ESO and the 4MOST Consortium are jointly organising the “Preparing for 4MOST” workshop, which will take place at ESO Garching on 6–8 May 2019. The purpose of this workshop is to transfer knowledge from the 4MOST Consortium to the broader ESO community, and hence to prepare the community for the exciting scientific opportunity to use 4MOST. This will assist potential community PIs to successfully respond to the Call, and will foster scientific collabora-

Table 3. 4MOST Consortium institutes and their main roles in the Project.

| Institute | Instrument responsibility | Science lead responsibility |
|---|--|---|
| Leibniz-Institut für Astrophysik Potsdam (AIP) | Management and system engineering, telescope interface (including WFC), metrology, fibre system, instrument control software, System AIV and commissioning | Milky Way Disc and Bulge LR Survey, Cosmology Redshift Survey, Magellanic Clouds Survey |
| Australian Astronomical Optics – Macquarie (AAO) | Fibre positioner | Galaxy Evolution Survey |
| Centre de Recherche Astrophysique de Lyon (CRAL) | Low-Resolution spectrographs | Cosmology Redshift Survey |
| European Southern Observatory (ESO) | Detectors system | |
| Institute of Astronomy, Cambridge (IoA) | Data management system | Milky Way Halo LR Survey |
| Max-Planck-Institut für Astronomie (MPIA) | Instrument control system hardware | Milky Way Disc and Bulge HR Survey |
| Max-Planck-Institut für extraterrestrische Physik (MPE) | Science operations system | Galaxy Clusters Survey, AGN Survey |
| Zentrum für Astronomie der Universität Heidelberg (ZAH) | High-Resolution spectrograph, Instrument control system software | Milky Way Halo HR Survey |
| NOVA/ASTRON Dwingeloo | Calibration system | |
| Rijksuniversiteit Groningen (RuG) | | Milky Way Halo LR Survey |
| Lund University (Lund) | | |
| Uppsala universitet (UU) | | Milky Way Disc and Bulge HR Survey |
| Universität Hamburg (UHH) | | |
| University of Western Australia (UWA) | | Galaxy Evolution Survey |
| École polytechnique fédérale de Lausanne (EPFL) | | Cosmology Redshift Survey |

tions between the community and the 4MOST Consortium. Members of the community who are considering applying for a 4MOST Public Survey are strongly encouraged to attend this meeting in order to obtain detailed information, and to have the opportunity to ask questions, exchange ideas, and build collaborations.

The latest information about 4MOST and its planned surveys is available on its website¹. Information can also be obtained through the 4MOST helpdesk, which can be reached through ESO's User Support Department², the 4MOST web site, or by mailing the project directly³.

Schedule

The 4MOST Project moved into full construction after passing Final Design Review-1 in May 2018. Major milestones in further development and construction are the release of the Call for Letters of Intent in the second half of 2019 which will have a submission deadline about

2 months later, completion of the system integration in Potsdam in July 2021, passing the full system test including operations rehearsals for the Preliminary Acceptance Europe by February 2022, and the installation and commissioning of the facility at VISTA for Provisional Acceptance Chile in November 2022, after which the first five year survey will start.

Consortium and Minor Participants Institutes

The 4MOST Consortium institutes and their main roles in the project are listed in Table 3. The following Minor Participant institutes are also contributing to the development of 4MOST: Durham University, University of Sussex, University College London, Institute for Astrophysics Göttingen (IAG), University of Warwick, University of Hull, Universität Potsdam, Laboratoire d'Etudes des Galaxies, Etoiles, Physique et Instrumentation (GEPI), IN2P3/Laboratoire des Matériaux Avancés (L.M.A.); and for the TiDES Sur-

vey: Lancaster University, Queen's University Belfast, University of Portsmouth, and University of Southampton.

Acknowledgements

Financial support for 4MOST from the Knut and Alice Wallenberg's Foundation, the German Federal Ministry of Education and Research (BMBF) via Verbundforschungs grants 05A14BA2, 05A17BA3 and 05A17VH4, and from the German Research Foundation (DFG) via Sonderforschungsbereich SFB 881 "The Milky Way System" is gratefully acknowledged.

References

Guiglion, G. et al. 2019, *The Messenger*, 175, 17
Walcher, C. J. et al. 2019, *The Messenger*, 175, 12

Links

¹ The 4MOST website: www.4most.eu
² ESO's User Support Helpdesk: usd-help@eso.org
³ 4MOST project mailing address: help@4most.eu

Notes

^a Roelof de Jong is the 4MOST Principal Investigator.

G. Gillet/ESO



The full moon sets behind VISTA near Paranal.

4MOST Scientific Operations

C. Jakob Walcher¹
 Manda Banerji²
 Chiara Battistini³
 Cameron P. M. Bell¹
 Olga Bellido-Tirado¹
 Thomas Bensby⁴
 Joachim M. Bestenlehner⁵
 Thomas Boller⁶
 Joar Brynnel¹
 Andrew Casey⁷
 Cristina Chiappini¹
 Norbert Christlieb³
 Ross Church⁴
 Maria-Rosa L. Cioni¹
 Scott Croom⁸
 Johan Comparat⁶
 Luke J. M. Davies⁹
 Roelof S. de Jong¹
 Tom Dwelly⁶
 Harry Enke¹
 Sofia Feltzing⁴
 Diane Feuillet¹⁰
 Morgan Fouesneau¹⁰
 Dominic Ford⁴
 Steffen Frey¹
 Eduardo Gonzalez-Solares²
 Alain Gueguen⁶
 Louise Howes⁴
 Mike Irwin²
 Jochen Klar¹
 Georges Kordopatis¹¹
 Andreas Korn¹²
 Mirko Krumpel¹
 Iryna Kushniruk⁴
 Man I Lam¹
 James Lewis²
 Karin Lind¹²
 Jochen Liske¹³
 Jon Loveday¹⁴
 Vincenzo Mainieri¹⁵
 Sarah Martell¹⁶
 Gal Matijevic¹
 Richard McMahon²
 Andrea Merloni⁶
 David Murphy²
 Florian Niederhofer¹
 Peder Norberg¹⁷
 Alexander Pramskiy³
 Martino Romaniello¹⁵
 Aaron S. G. Robotham⁹
 Florian Rothmaier³
 Gregory Ruchti⁴
 Olivier Schnurr^{1,18}
 Axel Schwobe¹
 Scott Smedley¹⁹
 Jenny Sorce^{20,1}
 Else Starckenburg¹
 Ingo Stiliz³
 Jesper Storm¹

Elmo Tempel^{21,1}
 Wing-Fai Thi⁶
 Gregor Traven⁴
 Marica Valentini¹
 Mario van den Ancker¹⁵
 Nicholas Walton²
 Roland Winkler¹
 C. Clare Worley²
 Gabor Worseck²²

- ¹ Leibniz-Institut für Astrophysik Potsdam (AIP), Germany
- ² Institute of Astronomy, University of Cambridge, UK
- ³ Zentrum für Astronomie der Universität Heidelberg/Landessternwarte, Germany
- ⁴ Lund Observatory, Lund University, Sweden
- ⁵ Physics and Astronomy, University of Sheffield, UK
- ⁶ Max-Planck-Institut für extraterrestrische Physik, Garching, Germany
- ⁷ School of Physics and Astronomy, Monash University, Melbourne, Australia
- ⁸ Sydney Institute for Astronomy, University of Sydney, Australia
- ⁹ International Centre for Radio Astronomy Research / University of Western Australia, Perth, Australia
- ¹⁰ Max-Planck-Institut für Astronomie, Heidelberg, Germany
- ¹¹ Observatoire de la Côte d'Azur, Nice, France
- ¹² Department of Physics and Astronomy, Uppsala universitet, Sweden
- ¹³ Hamburger Sternwarte, Universität Hamburg, Germany
- ¹⁴ University of Sussex, Brighton, UK
- ¹⁵ ESO
- ¹⁶ School of Physics, University of New South Wales, Sydney, Australia
- ¹⁷ Department of Physics, Durham University, UK
- ¹⁸ Cherenkov Telescope Array Observatory, Bologna, Italy
- ¹⁹ Australian Astronomical Optics – Macquarie, Sydney, Australia
- ²⁰ Centre de Recherche Astrophysique de Lyon, France
- ²¹ Tartu Observatory, University of Tartu, Estonia
- ²² Institut für Physik und Astronomie, Universität Potsdam, Germany

The 4MOST instrument is a multi-object spectrograph that will address Galactic and extragalactic science cases simultaneously by observing targets from a large number of different surveys within each science exposure. This parallel mode of operation and the survey nature of 4MOST require some distinct 4MOST-specific operational features within the overall operations model of ESO. The main feature is that the 4MOST Consortium will deliver, not only the instrument, but also contractual services to the user community, which is why 4MOST is also described as a facility. This white paper concentrates on information particularly useful to answering the forthcoming Call for Letters of Intent.

Operational context and requirements

4MOST is conceived as a survey facility that comprises the instrument and associated operations services. The largest fraction of the observing time on 4MOST will be allocated within a unique operational concept in which five-year Public Surveys from both the Consortium and the ESO community will be combined and observed in parallel during each exposure. These Surveys are jointly called Participating Surveys. ESO community members can also choose not to participate in this joint observing strategy by proposing a Non-Participating Survey. More details about the definitions and the selection procedures for Participating and Non-Participating Surveys can be found in the overview paper by de Jong et al., p. 3.

In the parallel observing mode, 4MOST will obtain spectra to serve many different science cases simultaneously. Parallel observing thus enables efficient use of 4MOST for surveys that have complementary observing conditions requirements and/or a target density lower than the 4MOST multiplexing capability. It also implies that surveys have to agree on a common survey strategy and prepare Observation Blocks (OBs) jointly. As a consequence, Participating Surveys will not explicitly choose the atmospheric conditions under which they wish to observe their targets. Rather, the design of the common survey strategy will be driven by observational success criteria.

These could, for example, be requirements on the signal-to-noise ratio (S/N) per target, or on the sky area to be covered. An additional consideration is that, owing to the nature of multi-object spectrographs, the spectra of targets will partially overlap on the detector (cross-talk between neighbouring fibres on the CCD). This implies that all Participating Surveys will have to fully share the raw data as well as the calibrated spectra in order to be able to assess and mitigate the impact of this cross-talk effect on their science.

4MOST operations have been designed to work within ESO's La Silla Paranal Observatory framework, with as few changes to infrastructure and processes as possible. Still, two main differences from the standard ESO science operations model are necessary: (1) a joint science team for all Participating Surveys (i.e., including Community Surveys as well as those from the instrument-building Consortium); (2) common centralised

tasks in observation preparation and data management that are provided as a service by the Consortium.

The survey nature of 4MOST operations means that Targets of Opportunity or time-constrained observations on timescales shorter than a few days cannot be accommodated. However, transients that are numerous enough that they fall in randomly distributed 4MOST pointings can be observed if they can be included into the data stream with a few days lead time. Also, targets that require re-visits with a certain cadence can, in principle, be accommodated, in particular for deep fields requiring many visits. Towards the end of this paper we discuss the distinct case of Non-Participating Surveys, i.e., surveys that wish to use 4MOST in single survey mode.

Within 4MOST we define three data levels as follows: Level zero (L0) data are raw data, calibration data, environmental data, and log files; Level one (L1) data are

one-dimensional (1D), calibrated, science-ready spectra extracted from the raw data; and Level two (L2) data are products resulting from the science analysis of 1D spectra, in particular physical properties of 4MOST targets. Examples of L2 data include elemental abundances for stars or redshifts and emission line fluxes for galaxies. L2 products also include spectra stacked over several OBs. L2 products that are to be delivered to ESO in Phase 3 are deliverable L2 (DL2) products. Any survey may also generate additional L2 (AL2) products.

Organisational setup and roles

An organisation chart for the operations phase is shown in Figure 1. The Science Team is composed of all scientific members of all Consortium and Participating Community Surveys; it is the primary exploiter of 4MOST data. The Science Coordination Board represents the 4MOST Surveys and consists of all

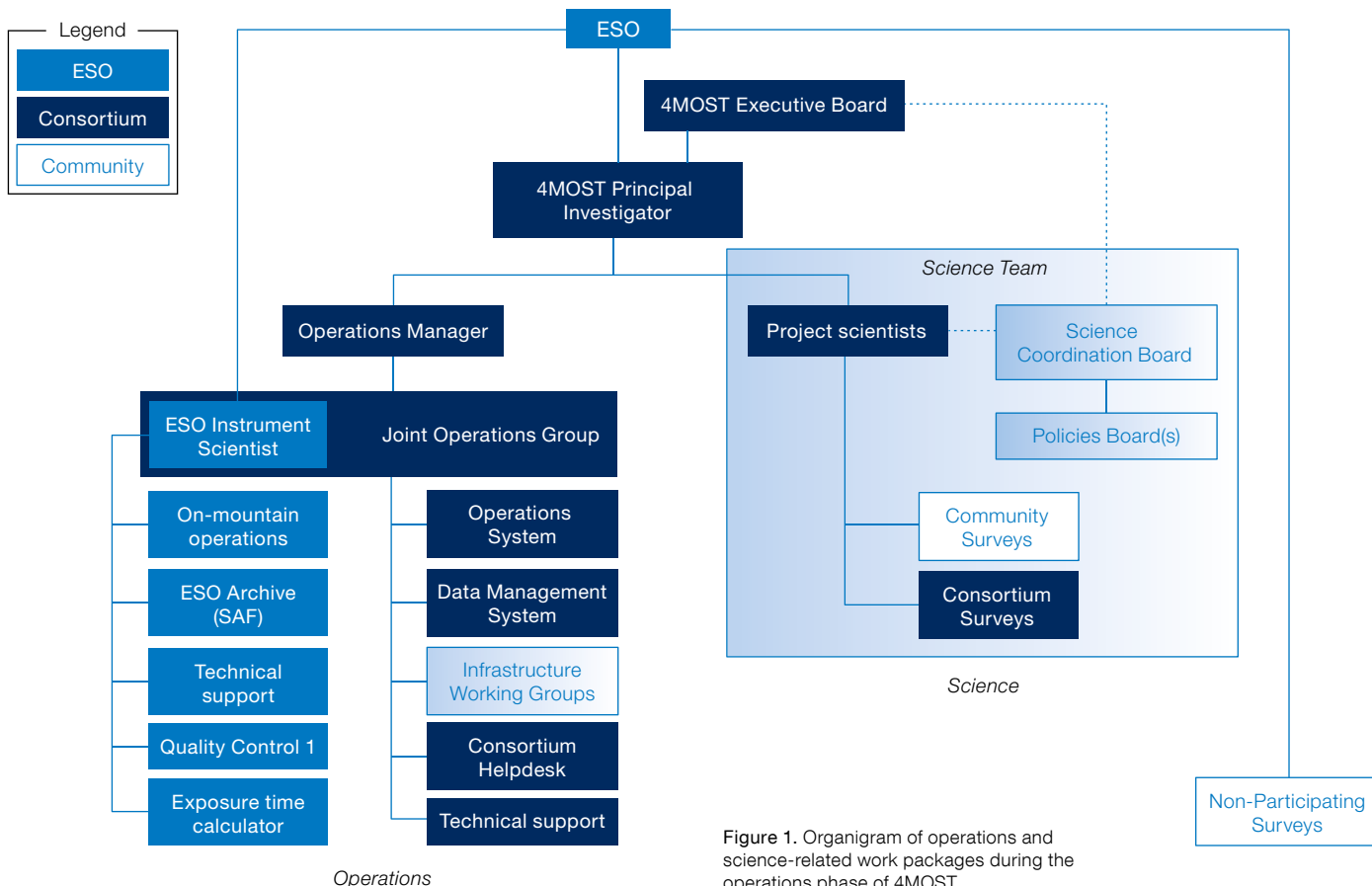

Figure 1. Organigram of operations and science-related work packages during the operations phase of 4MOST.

Consortium and Community Survey Principal Investigators (Survey PIs). It coordinates the scientific programmes of the surveys, in the spirit of a single overall 4MOST survey programme. It mediates potential conflicts of interest, and enforces the Science Team Policies. The day-to-day implementation of the Science Team Policies is delegated to the Science Policy Board.

Coordination of the diverse group of stakeholders for 4MOST operations is ensured by the Joint Operations Group. The Joint Operations Group implements the scientific and operational guidance given by ESO, the Survey PIs, and the 4MOST PI. It contains representatives from the various work packages in operation. Its main task is to ensure observations progress with the best possible quality over the entire survey duration.

Infrastructure Working Groups perform tasks common to all surveys. Their members are also members of the Science Team and are delegated to operations. Every Participating Survey is requested to provide resources to the Infrastructure Working Groups. The current working groups are: “Survey Strategy”; “Selection Functions”; “Galactic Pipeline”; “Extragalactic Pipeline”; and “Classification Pipeline”. Work in these groups has already started and Community Participating Surveys will be invited to join. This means not only profiting from the work already done, but also providing resources for ongoing development and operations.

Science Data Flow for Participating Surveys

The data flow through the 4MOST facility (see Figure 2) will follow concepts that are familiar to most astronomers working with either ESO or large survey projects. In a nutshell, the following steps in the data and workflows are foreseen:

1. Preparation of target catalogues with relevant associated data (for example, figures of merit) by surveys.
2. Submission of target catalogues to the Operations System.
3. Merging of catalogues and preparation of OBs by the Operations System.
4. Submission of OBs to ESO.

5. Execution of OBs at the Visible and Infrared Survey Telescope for Astronomy (VISTA) by ESO.
6. Transfer of raw data from the telescope to the Data Management System.
7. Data reduction from raw data to calibrated spectra by the Level 1 pipeline of the Data Management System.
8. Transfer of Level 1 data to advanced pipelines.
9. Data analysis and creation of Level 2 data products by advanced pipelines.
10. Transfer of all data to archives.
11. Science exploitation by surveys and the world-wide community.

Feedback loops

There are three feedback loops in this workflow:

1. Quality Control 0 will be carried out directly after an OB has been completed at the telescope. Quality Control 0 will only verify that the OB has been executed successfully in a technical sense. Even if some atmospheric or other conditions have not been met in a completely observed OB, it may still yield data for numerous targets where sufficient photons were received to fit the requirements. For targets where the required S/N has not been met, the exposure time still required can be optimised in a later re-observation of the same field.
2. The Data Management System will assess the observational progress per target as part of the Level 1 pipeline. This assessment is based on spectral success criteria provided by each survey. Progress per target will be communicated to the Operations System in order to be taken into account during the preparation of the next round of OBs.
3. The Operations System of the Consortium will provide a progress database allowing surveys and ESO to monitor observational survey progress at least fortnightly, using metrics such as a figure of merit or the number of successfully observed targets. If a survey falls behind expectations, changes to the survey strategy are possible with the approval of the Science Coordination Board and ESO.

Observing preparations

The Operations System is in charge of preparing the OBs for the 4MOST Participating Surveys. The target catalogues of the Participating Community Surveys will be merged with those of the Consortium, and through an iterative process a joint survey plan will be developed to observe all targets. The Operations System provides tools to estimate the feasibility and likely success of 4MOST observations. Its exposure time calculator delivers the same results as the one ESO provides, but is optimised such that hundreds of thousands of spectra can be treated jointly.

The 4MOST Facility Simulator is able to simulate the operation of 4MOST, including instrument performance, observatory processes, and weather patterns. Both the simulator and the OB builder use the same target catalogues. Additionally, to enable the planning of a common survey strategy, the surveys are required to deliver Spectral Success Criteria and figures of merit. The former are used to determine exposure times for each target. The latter are used to evaluate how well a specific survey has been able to meet its science goals. More details about the tools and procedures to develop a common Survey Strategy Plan are given in the 4MOST survey plan white paper by Guiglion et al. (p. 17).

The Operations System will prepare OBs approximately every three days, taking into account the latest information from the Data Management System on targets that have already been (partially) completed in previous observations. OBs are generated for the next two weeks providing redundancy in case of a connection breakdown between Europe and Paranal. The regular updates of OBs allow for optimised efficiency in observations. The Operations System also hosts a progress database that contains the current observational status for all Participating Surveys (see above).

Data reduction and analysis

The Data Management System is in charge of developing and running the Level 1 data reduction pipeline for all

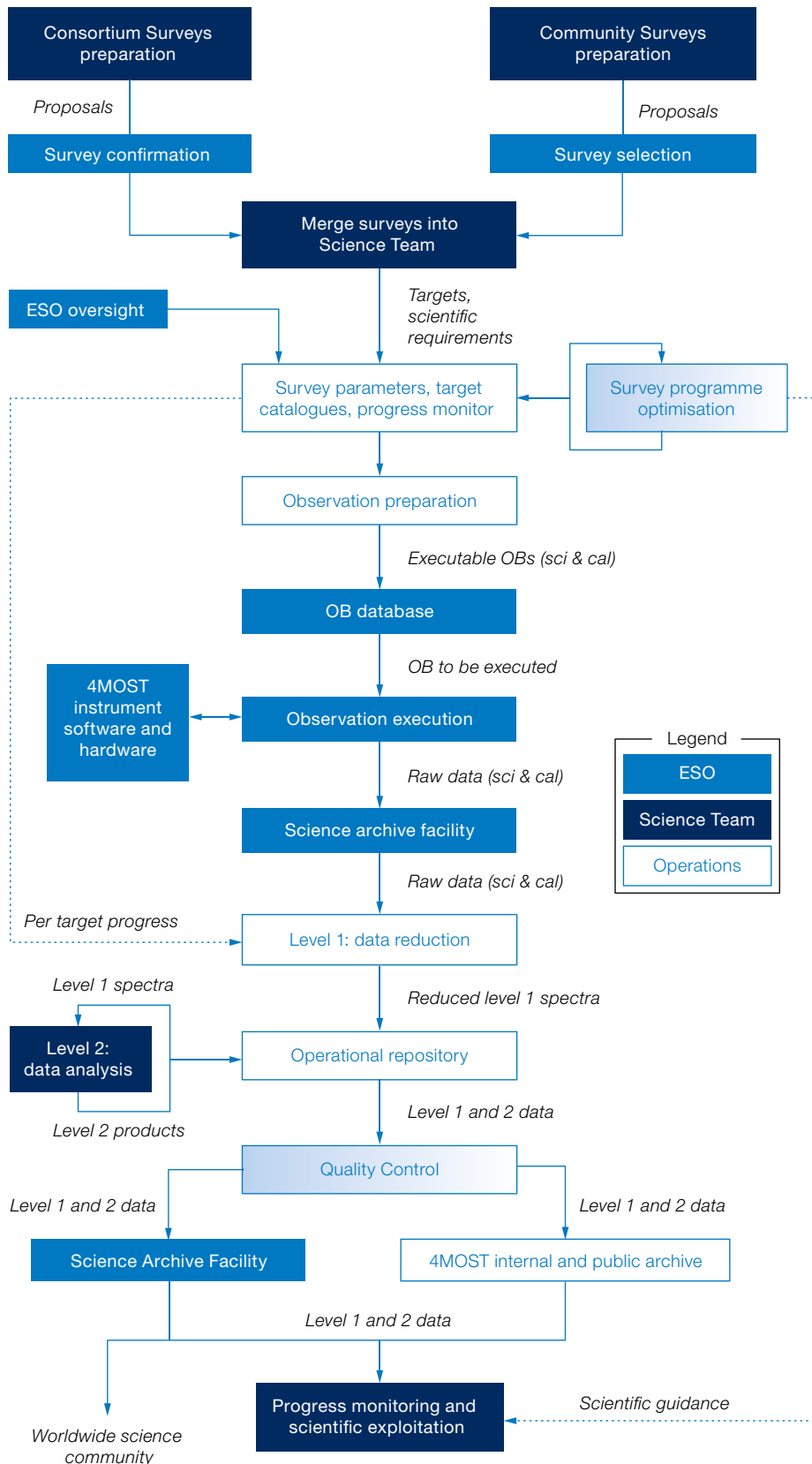

Figure 2. Schematic overview of work and data flows of the 4MOST project during survey operations for Participating Surveys.

surveys. This pipeline will remove the instrumental signatures and calibrate the raw data. It will produce all Level 1 data products, including the 1D spectra, their associated variances and bad pixel masks as well as any other associated information. The data reduction pipeline will also generate per-target progress information to be used by the Operations System in its progress monitor and for the preparation of future observations.

The Level 1 data products are primarily used by the advanced pipelines, which produce the advanced Level 2 data products. Currently, there are four advanced pipelines: the classification pipeline; the Galactic pipeline; the extragalactic pipeline; and the selection functions pipeline. These pipelines are developed in Infrastructure Working Groups (see above). The outputs from the advanced pipelines are described in Data eXchange Unit (DXU) documents, which are available on the 4MOST website.

In brief, the classification pipeline will provide a data-driven classification of spectra into stars, galaxies, AGN, outliers and unclassifiable objects. The Galactic pipeline will derive effective temperatures, surface gravities, and element abundances for cool stars, hot stars, and white dwarfs. The extragalactic pipeline will deliver object redshifts, as well as emission line fluxes and stellar population properties. Finally, the selection function pipeline will compute two selection functions — geometric and target. The geometric one can be used to correct for the incompleteness incurred owing to the size and shape of the field of view, tiling, and fibre positioner properties. The target selection function can be used to correct for the effects of finite exposure times and the throughput of 4MOST. Surveys can fold both of these selection functions with the specific target selection procedure per survey, providing an incentive to use a clean and reproducible survey selection function.

The Data Management System will store all data products (Levels 1 and 2)

in a 4MOST Operational Repository. The quality control of data in the repository will be carried out by a working group coordinated by the Quality Control Scientist. The Science Team as a whole will have access to quality controlled data products in three-month intervals as internal releases will be pushed from the repository to the 4MOST Public Archive maintained by the Consortium.

As for all Public Surveys carried out at ESO facilities, the raw data will become public automatically via the ESO Science Archive Facility (SAF). Level 1 data products will be submitted by the Consortium to the SAF and made public by the SAF on a regular basis (nominally yearly). Deliverable Level 2 data products will be submitted to and made public by the SAF on a schedule to be agreed between the 4MOST survey program and ESO. Level 2 data products will naturally lag behind Level 1 spectra by some amount of time that may also depend on the specific survey/data product type. All Level 1 and deliverable Level 2 products will be released not only through the ESO SAF, but also worldwide through the 4MOST Public Archive operated by the Consortium, which in addition may contain matched catalogues from other facilities and added value catalogues with data processed beyond the standard pipelines (additional Level 2 products).

4MOST Helpdesk and finding further information

The Consortium-operated 4MOST Helpdesk is tasked with answering questions from all stakeholders in 4MOST (including potential or actual proposers, Participating Survey teams, and users of worldwide data releases). It is reachable by e-mail¹, through an online form accessible from the project webpage², and will also serve as a back office for the ESO User Support Department in respect of 4MOST-related questions. The 4MOST Helpdesk is operated by Consortium members and maintains a webpage with frequently asked questions. The webpages of the 4MOST Consortium complement the white papers in this issue of The Messenger with more information. Some key documents will be made available through the webpages, such as the Science Team Policies and details on the planned advanced data products.

Non-Participating Surveys: a special mode of operation

4MOST has been designed to cover the southern hemisphere in a five-year survey using a parallel mode of observation, enabling surveys that would otherwise not be possible. All Consortium Surveys will be carried out in the parallel mode of observations. At the same time, 4MOST is also a very powerful instrument that

can be used in single survey mode if the target density is sufficiently high. In this mode, special thought has to be given to the use of fibres from both Low- and High-Resolution Spectrographs. Proposed Community Surveys wishing to use 4MOST in single survey mode are called Non-Participating Surveys. They will not become members of the Science Team, and will not be bound by the Science Team Policies. Their time will be allocated in named nights or half-nights to enable accurate planning. The Consortium Operations System will deliver the software necessary to produce OBs, which Non-Participating Surveys will run themselves. The Consortium Data Management System will deliver Level 1 data products to Non-Participating Surveys through the Operational Repository. Non-Participating Surveys will not have access to the advanced pipelines developed in the 4MOST Science Team. Non-Participating Surveys will have to produce and upload their own Level 2 products to ESO.

Acknowledgements

In addition to the authors of this white paper, the support of many individuals within the 4MOST project and within ESO has been important for the development of the 4MOST operations planning.

Links

¹ 4MOST helpdesk: help@4most.eu

² 4MOST webpage: www.4MOST.eu

The Milky Way arches over the VLT (clearly deploying its laser guide star capability) and VISTA (on the right). By 2022, VISTA will have transformed into 4MOST with operations beginning towards the end of the year.



G. Hudepohl (atacamaphoto.com)/ESO

4MOST Survey Strategy Plan

Guillaume Guiglion¹
 Chiara Battistini²
 Cameron P. M. Bell¹
 Thomas Bensby³
 Thomas Boller⁴
 Cristina Chiappini¹
 Johan Comparat⁴
 Norbert Christlieb²
 Ross Church³
 Maria-Rosa L. Cioni¹
 Luke Davies⁵
 Tom Dwelly⁴
 Roelof S. de Jong¹
 Sofia Feltzing³
 Alain Gueguen⁴
 Louise Howes³
 Mike Irwin⁶
 Iryna Kushniruk³
 Man I Lam¹
 Jochen Liske⁷
 Richard McMahon⁶
 Andrea Merloni⁴
 Peder Norberg⁸
 Aaron S. G. Robotham⁵
 Olivier Schnurr^{1,9}
 Jenny G. Sorce^{10,1}
 Else Starkenburg¹
 Jesper Storm¹
 Elizabeth Swann¹¹
 Elmo Tempel^{12,1}
 Wing-Fai Thi⁴
 C. Clare Worley⁶
 C. Jakob Walcher¹
 and The 4MOST Collaboration

- ¹ Leibniz-Institut für Astrophysik Potsdam (AIP), Germany
- ² Zentrum für Astronomie der Universität Heidelberg/Landessternwarte, Germany
- ³ Lund Observatory, Lund University, Sweden
- ⁴ Max-Planck-Institut für extraterrestrische Physik, Garching, Germany
- ⁵ International Centre for Radio Astronomy Research/University of Western Australia, Perth, Australia
- ⁶ Institute of Astronomy, University of Cambridge, UK
- ⁷ Hamburger Sternwarte, Universität Hamburg, Germany
- ⁸ Department of Physics, Durham University, UK
- ⁹ Cherenkov Telescope Array Observatory, Bologna, Italy
- ¹⁰ Centre de Recherche Astrophysique de Lyon, France

¹¹ Institute of Cosmology and Gravitation, University of Portsmouth, UK
¹² Tartu Observatory, University of Tartu, Estonia

The current status of and motivation for the 4MOST survey strategy, as developed by the Consortium science team, are presented here. Key elements of the strategy are described, such as sky coverage, number of visits and total exposure times in different parts of the sky, and how to deal with different observing conditions. The task of organising the strategy is not simple, with many different surveys that have vastly different target brightnesses and densities, sample completeness levels, and signal-to-noise requirements. We introduce here a number of concepts that we will use to ensure all surveys are optimised. Astronomers who are planning to submit a Participating Survey proposal are strongly encouraged to read this article and any relevant 4MOST Survey articles in this issue of *The Messenger* such that they can optimally complement and benefit from the planned surveys of the 4MOST Consortium.

4MOST is a new wide-field spectroscopic survey facility to be mounted on the 4-metre VISTA telescope. Observations are expected to start in 2022 after which 4MOST will be running multiple survey periods, each of a five-year duration. More details of the 4MOST instrument and proposal submission process can be found in the 4MOST overview paper (De Jong et al., p. 3). For more details of scientific operations, we refer the reader to the 4MOST Scientific Operations paper (Walcher et al., p. 12).

The multiplex of 4MOST is so large that few science cases have sufficiently high target densities to fill all the fibres in a 4MOST field of view on their own. There are many important science cases that need only a few targets in each field of view but have targets spread over the entire sky. To efficiently fill all the fibres and to make low-target-density surveys possible, it was realised early on that 4MOST would benefit from an operations scheme in which most 4MOST science

programmes are merged into one survey and observed simultaneously. The use of the 4MOST Guaranteed Time Observations was developed around this concept and constitutes the Consortium Survey Plan presented here. The ESO community is invited to participate in this joint strategy, giving such Participating Surveys the added benefit that the exposure time of targets in common with other surveys will be shared proportionately.

The current survey plan is subject to change due to several factors. Most importantly, the new Community Surveys that will be added to the overall 4MOST survey programme following the proposal process led by ESO will most likely introduce new strategy requirements. Changes can also be expected when further knowledge is obtained regarding the sensitivity of the instrument and its overheads performance as it is further developed, built and tested. Therefore some of the information in what follows is preliminary and subject to change. Up-to-date information on 4MOST, its performance and Survey Strategy will be continuously posted on the 4MOST webpage¹.

Basic concepts and default strategy

All 4MOST observing programmes are carried out by surveys, each of which can consist of several sub-surveys. Running 4MOST efficiently with many surveys in parallel demands an observing plan that can accommodate targets requiring very different exposure times. Some of the brightest stars may reach their required signal-to-noise (S/N) ratios in five minutes using the Low Resolution Spectrograph (LRS), whereas faint extragalactic targets or faint stars observed with the High Resolution Spectrograph (HRS) could require two hours of total exposure time. The operations scheme must also be able to adapt to different observing conditions (for example, sky brightness and seeing).

To accommodate the different exposure times, the total exposure time in an area on the sky is broken up into individual exposures. For each exposure, the fibres are repositioned in a new configuration such that targets that can be finished in one exposure receive a fibre only once, while other targets receive a fibre multiple

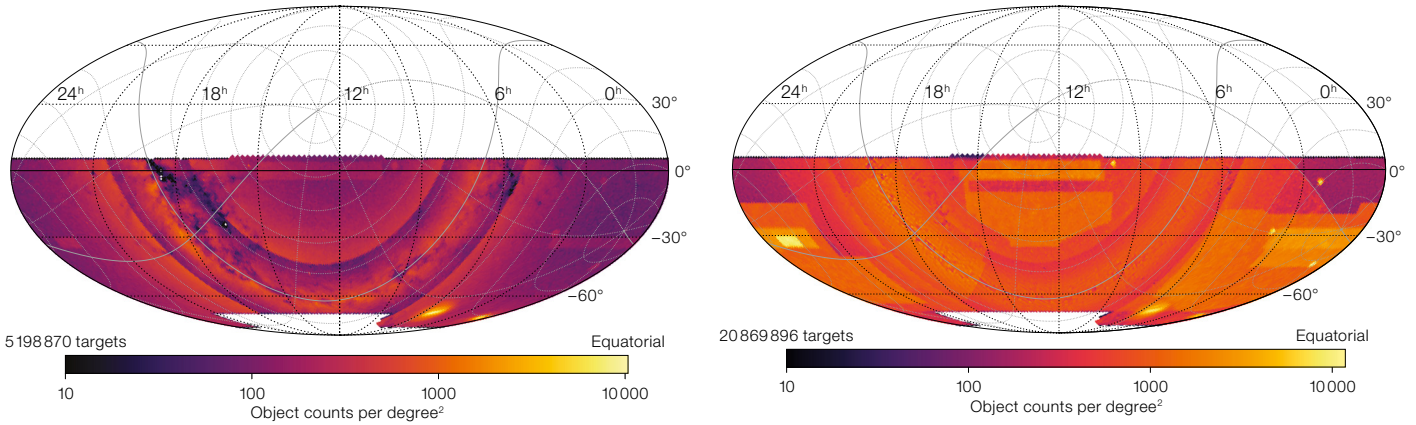

times in the different fibre configurations until they reach the required S/N. To save the overheads of repositioning the telescope and acquiring guide stars, several fibre configuration exposures can be grouped into one Observation Block (OB) that is then observed in one telescope visit at that pointing. While we expect that exposure times will be typically of order 20 minutes, shorter times will be used in areas with many bright sources at the cost of some extra overheads. The maximum individual exposure time for a configuration is set at 30 minutes, because changing differential refraction across the field would cause fibres to drift if exposed much longer.

The fibre usage efficiency of a grid-based fibre positioner such as that used by 4MOST is increased when the target density is significantly higher than the fibre density in the field of view. Therefore, science cases that can provide many more interchangeable targets than needed to fulfil the science case increase the efficiency of the joint survey programme.

To get a feeling for what is possible with 4MOST, we can assume a baseline strategy of visiting a large fraction of the southern sky twice, with each visit having three fibre configurations exposed for 20 minutes each. Given that Paranal provides about 300 useable nights per year with on average duration of 9 hours, along with 4MOST's field of view of 4.2 square degrees, we can expect to cover about 21 000 square degrees in a five-year survey with two hours total exposure time, assuming about 75% effective open shutter time. Such a basic strategy would

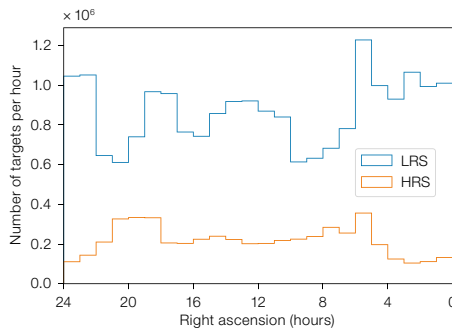

Figure 1. The summed target densities of Consortium Surveys for the HRS (upper left) and the LRS (upper right) sampled to the requested completeness, as a function of RA and dec. The area covered is representative the current survey plan. The lower panel presents histograms of the targets as a function of RA.

Observing conditions

Because many targets from different surveys are observed simultaneously, proposers cannot request specific observing conditions (seeing, Moon) on a per target level. In order to avoid having too wide a range in target brightness in one area of the sky and to simplify scheduling, the Consortium has identified the disc plane of the Milky Way as the region that will predominantly be observed during bright time, with the rest of the sky devoted mostly to grey and dark time. This means that targets with a fibre luminosity fainter than that of the bright sky will be hard to schedule at low Galactic latitude, with the possible exception of some areas near the bulge where some dark/grey time will be used. The algorithm to assign targets and sky areas to dark/grey/bright observing time is still being improved and hence current diagrams are based on a simplified approach and are only indicative of the final strategy.

allow one to cover the entire sky in the declination range $-70 < \text{dec} < 5$ degrees. This particular preferred declination range was chosen for two reasons. Firstly, one needs to avoid having to cover too much sky in the north where observing time is limited by the regular occurrence of strong northerly winds at Paranal. Secondly, the 4MOST Atmospheric Dispersion Corrector only functions up to a 55-degree zenith distance and hence observations at airmasses larger than 1.75 will see significant sensitivity losses at the ends of the spectral range. Therefore, large numbers of particularly long observations at $\text{dec} < -70$ degrees should be avoided.

To cover special areas on the sky with exposures longer than two hours or outside this fiducial declination range therefore requires giving up coverage and/or total exposure time within certain areas of this sky declination range. A description of the relative coverage of different regions by the 4MOST Consortium Surveys is provided below.

Observers will not be able to specify seeing conditions for their observations. When necessary, longer exposure times will be used for a field to match the observing conditions. On a larger scale, we expect to tune the scheduling algorithm such that areas with many background-limited, point-like sources or regions that are hard to complete (for

example, high-airmass or high-right-ascension [RA] pressure regions) will automatically be assigned better seeing conditions.

Encoding the scientific drivers of the survey strategy

In order to have an automatic routine that can develop an observing strategy that is both efficient and reproducible at least in a statistical sense, surveys need to provide a number of other parameters alongside their target catalogues, such that target selections and observing schedules can be optimised. These parameters are described in this section.

In this framework, the Spectral Success Criteria (SSC) were defined at the target level and are used to set the initial exposure time requirement. The SSC prescribe the S/N requirements in specified wavelength regions of the target spectrum needed for robust scientific output. As an example, to achieve a sufficient precision in the stellar parameters, the median S/N ratios in the continuum over given wavelength ranges have to reach at least a certain value. Such criteria are provided by all individual 4MOST Surveys for all of their targets and depend on their individual scientific goals. 4MOST operations are also expected to include a feedback loop on already observed targets. Surveys must therefore also provide “stop observing” criteria for all targets. These are evaluated after the first exposure(s) of a target have been taken in one OB and may be used to make decisions if subsequent observations in this region of the sky are planned. Examples of stop criteria are: a minimum S/N has been reached (which can be lower than the original request); a redshift has been obtained; or a maximum exposure time has been exceeded.

The Small Scale Merit (SSM) is used by the target scheduling tool that assigns fibres to targets to quantify the success of observations in a small area of the sky. The SSM defines the completeness requirements of a (sub-)survey on a scale of one fibre configuration, i.e., an area covering a 4MOST field of view. Indeed, the different surveys require different completeness in a given local area, with differing numbers of targets. The SSM

is then a way to quantify the increment of scientific knowledge we acquire when observing an additional target in one survey versus another. This allows surveys to provide many more targets than needed for their science case and, by specifying that only a fraction of targets need to be completed, helps improve the fibre usage efficiency. Using the total observing time assigned to a region and the target exposure times calculated with the SSCs, an algorithm is used to assign targets to fibres in a field of view in a probabilistic way such that the desired completeness is reached for each survey, while avoiding unwanted biases in brightness or crowding, for example. The use of probabilities throughout selection and operation decisions will greatly simplify re-creating the selection functions that one needs to make statistical inferences on the intrinsic abundances of different types of targets.

In order to coordinate the science goals over a large area of the sky, the Consortium uses the Large Scale Merit (LSM). The LSM concerns the entire observable sky and is defined by a HEALPix^{a,2} map of scientific priorities as a function of right ascension and declination. The LSM maps are needed to ensure that observations concentrate on areas of higher scientific interest. As an example, surveys can use the LSM to reduce the priority of regions with high levels of extinction.

In order to obtain an overall measure of 4MOST survey success a figure of merit (FoM) is defined by each survey. This metric ranges from 0.0 to 1.0, and can be a function of the successfully observed targets, areas completed with sufficient number of targets, and completeness of individual sub-surveys with special targets. The FoM is defined such that it reaches 0.5 once a survey has met its requirements (the minimum set of observations to accomplish the core science case) and it reaches 1.0 once it has met all its goals. The goal of the 4MOST observation scheduling software is of course to maximise this FoM for all surveys, without penalising any of the surveys. The choice and implementation of these LSM and SSM concepts contribute to the final shape of the 4MOST sky.

The accompanying white papers from the different 4MOST Surveys in this issue of

The Messenger provide examples of SSC and FoM usage.

Survey strategy simulations

To check the feasibility of the 4MOST strategy, the project developed the 4MOST Facility Simulator (4FS), a software tool used to simulate the progress of the five-year 4MOST Survey. The 4FS is used to plan, optimise and verify many aspects of operations planning. The 4FS contains a detailed parameterised model of the 4MOST Facility, including representations of the instrument focal plane, the various constraints/limitations, and a statistical model of the operating environment (for example, the long-term atmospheric/environmental conditions at Paranal, maintenance procedures, etc.). Where possible, the 4FS uses prototype versions of the various algorithms that will be used to operate the real 4MOST Survey, for example, fibre-to-target assignment, survey strategy, survey scheduling, and progress balancing/feedback algorithms. The 4FS serves as the primary test-bed for development and optimisation of these algorithms and their optimal control parameters.

The simulator provides the means to inspect the simulated 4MOST performance on many levels, from individual target classes in sub-surveys, to survey completeness levels, fibre efficiency, and tension between different survey requirements in different parts of the sky and with time. Here we present only a few overview plots of the current Consortium Survey plan, which will be further optimised once combined with the Community Surveys.

First, we present in Figure 1 the requested density of targets as a function of RA and dec as well as a histogram of requested targets as a function of RA. These target densities have been built from preliminary target catalogues submitted by all Consortium Surveys, Galactic and extragalactic jointly, and limited to areas that are in the current survey plan. Community Surveys that match these target distributions will be easiest to schedule.

Figure 2 shows the exposure time distribution over the sky in a recent realisation of a five-year survey with 4FS. The fiducial

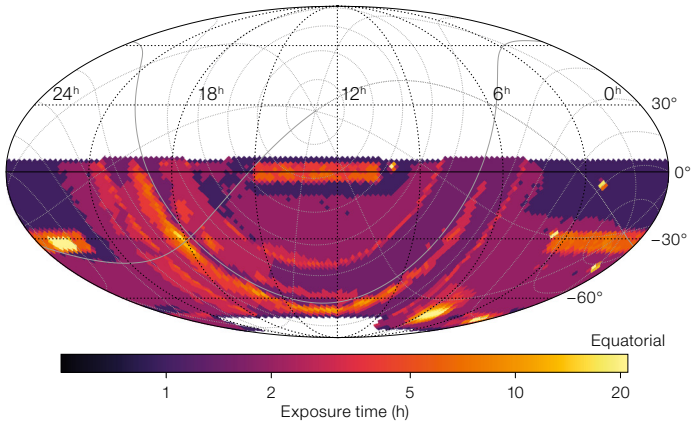

Figure 2. The total exposure time in various areas of the sky in a recent simulation with the 4MOST Facility Simulator.

survey strategy of 4MOST foresees that every field will be observed twice with Observation Blocks containing three fibre configurations with exposure times of about 20 minutes each. However, as mentioned before, the survey teams have identified the need for special survey areas that have higher requested target densities and/or have fainter targets and hence require more exposure time. These regions and their approximate total exposure times are listed in Table 1. To make this possible, the current strategy avoids, or strongly reduces, the amount of exposure time in high extinction areas in the Milky Way disc. In addition, some areas in the $-10 < \text{dec} < 5$ degree range have reduced exposure times as there are no targets available in these areas from the X-ray eROSITA Surveys (S5 Clusters and S6 active galactic nuclei [AGN]).

The colour code of the map of Figure 2 indicates the total exposure time allocated to each part of the sky. Typically, the stellar (i.e., Galactic) surveys have brighter targets while the extragalactic ones have many targets that cannot be observed when the Moon is present. Therefore, most of the bright time is dedicated to the Milky Way disc regions. However, some dark/grey time will be allocated to mostly stellar fields as well as to enable deeper observations, for instance in the Milky Way bulge and the Magellanic Clouds. Conversely, when the Milky Way disc is not visible bright time will be used at higher Galactic latitude to observe bright targets there.

| Location | Area (square degrees) | Average t_{exp} (hours) |
|---------------------------|-----------------------|----------------------------------|
| Bulge and Inner Galaxy | 500 | 4–6 |
| Magellanic Clouds | 200–300 | 2–10 |
| WAVES-Wide | 1300 | 3–4 |
| WAVES-Deep | 50 | 7 |
| LSST Deep Drilling Fields | 4 × 4.2 | 4 × 60 |
| South Ecliptic Pole area | 300 | 4 |

Table 1. Planned special areas in the survey plan with their approximate total area and typical total exposure time per pointing.

Table 2 lists the approximate total numbers of targets that are expected to be observed by the individual surveys and that were shown to be feasible in a recent 4FS simulation based on the preliminary target catalogues. While these numbers are close to the goals of each survey, further tuning and balancing between the surveys will lead to subsequent modification of the final statistics.

In running the 4FS it is assumed that the survey strategy remains the same over the entire five-year period. In practice this may not be fully tenable and a feedback loop foresees that adjustments may be made on about a yearly timescale to ensure that all surveys progress on a common scale. However, changes, especially also on the target input catalogues, are expected to be kept to a minimum to ensure that the calculation of selection functions are tractable.

A number of other key elements pertinent to 4MOST Surveys that cannot be demonstrated with this high-level overview are described in the next sections.

Cadence and time variable sources

As 4MOST is a multi-object survey facility, it cannot deliver timed observations for individual targets. However, using minimal constraints on the scheduling of the observations, variable sources and transients are part of the science cases for some of the 4MOST Surveys. In order to deliver reliable scientific output for these targets, the 4MOST Survey needs to adopt a cadence in its observations. The executed time sequence may be

irregular and there can be no guarantee that all repeats will be performed at the scheduled time. The schedule of re-observation of targets is independent of the final total S/N ratio. However, in many cases there is a requirement on the minimum S/N ratio to be reached for a given visit.

Two Consortium Surveys require particular cadences: 1) TIDES, which aims at following up variable AGN and LSST transients, covering LSST Deep Drilling Fields; and 2) the Magellanic Clouds Survey (1001MC) for the pulsating variables stars. The Galactic Surveys can also benefit from the observing cadence as the plan is to observe the whole 4MOST sky at least twice, and, by assuring that there is at least one year between revisits rather than a few months, a larger fraction of binary stars can be identified by their variable radial velocities.

The planned deep fields are natural places to observe variable objects requiring repeat visits. While it will not be possible to perform timed observations, it is expected that a minimum and possibly a maximum duration between repeats can be specified to drive the schedule. The goal is for instance to observe the four declared LSST Deep Drilling Fields about every two weeks plus or minus a few days in order to perform reverberation mapping of AGN. If LSST decides to define another Deep Drilling Field in the South Ecliptic Pole area, this field may replace one of the currently defined four fields. Also repeat fields in the Milky Way bulge area will be used to study variable objects.

Another class of time-variable sources are transients. It will be possible to add a small number of transients, such as recently discovered supernovae, to a survey catalogue over the course of the

| Consortium Survey | Brightness range (magnitudes) | Targets (millions) |
|--|-------------------------------|--------------------|
| S1 Milky Way Halo LR | $15.0 \leq G \leq 20.0$ | 1.5 |
| S2 Milky Way Halo HR | $12.0 \leq G \leq 17.0$ | 1.5 |
| S3 Milky Way Disc and Bulge LR (4MIDABLE-LR) | $14.0 \leq G \leq 19.0$ | 10.0 |
| S4 Milky Way Disc and Bulge HR (4MIDABLE-HR) | $10.0 \leq G \leq 15.5$ | 2.5 |
| S5 Galaxy Clusters | $18.0 \leq r \leq 22.0$ | 1.7 |
| S6 AGN | $18.0 \leq r \leq 22.8$ | 1.0 |
| S7 Galaxy Evolution (WAVES) | $18.0 \leq r \leq 22.5$ | 1.6 |
| S8 Cosmology Redshift Survey | $20.0 \leq r \leq 23.9$ | 8.0 |
| S9 Magellanic Clouds (1001MC) | $10.5 \leq G \leq 19.5$ | 0.5 |
| S10 Transients (TIDES) | $18.0 \leq r \leq 22.5$ | 0.3 |
| Total | | > 28 |

Table 2. The minimal number and typical magnitude range of targets that each Consortium Survey expects to observe in the first five-year survey of 4MOST.

programme have yet to be determined. This programme consists of all stars in Gaia Data Release 3 (DR3) with $\text{dec} < +30$ degrees and in the brightness range $7.5 < G < 11$ magnitudes for HRS, and $11 < G < 12.5$ magnitudes for LRS. This will ensure 4MOST spectroscopy for all stars that form the core samples of the TESS and PLATO space missions. These missions will provide key asteroseismology information that can be used not only to improve the precision on the derived stellar parameters and chemical abundances, but also to compute masses and ages. This makes this sample an ideal calibration and training set for the entire 4MOST Survey. It is expected that almost all of these stars can be observed in less than five years, after which a fraction of them will be regularly repeated with a cadence that still has to be determined.

Prospects

The 4MOST strategy described in this document is not yet frozen and will need further optimisation. Regular updates will be made, especially when accommodating accepted community proposals. Also, a better understanding of instrument performances will impact the final strategy, as well as further advances in the fields of the presented science cases. As the 4MOST project progresses towards first light more features will be added to the 4MOST Facility Simulator to increase the fidelity of real observations and to encode more science drivers from the surveys. The latest released survey strategy plan can be found via a webpage³ that will be regularly updated.

Links

- ¹ The 4MOST webpage: www.4most.eu
- ² HEALPix webpage: <https://healpix.jpl.nasa.gov/>
- ³ 4MOST Survey Simulations webpage: <https://www.4most.eu/cms/operation/simulations/>

Notes

- ^a HEALPix is an acronym for Hierarchical Equal Area isoLatitude Pixelization of a sphere, a pixelisation procedure that produces a subdivision of a spherical surface in which each pixel covers the same surface area as every other pixel.

five-year survey period. Because OBs that drive the observations on the telescope are re-created in intervals of three days, this is also the lead time for adding transient objects. Data from the LSST survey will provide several live transients with durations of several weeks that are visible within one 4MOST field of view at any pointing on the sky. These transients are bright enough that, by adding these targets to the 4MOST target catalogue with high priority, spectra will be obtained by targeting several transients in each observation, following the nominal survey plan of 4MOST.

Finally, several surveys wish to optimise the sky coverage such that a contiguous area is covered, which has implications for the cadence. The optimisation process for preferentially covering large (≥ 500 square degrees), contiguous areas of the sky is still under development.

Calibration

An important ingredient of the 4MOST survey strategy is the calibration plan. The instrument and data calibration will follow standard procedures for multi-object spectroscopic instruments. The moving spine principle of the positioner will cause variability in the throughput of individual fibres for each science exposure. Therefore the instrument has the capability to take one additional calibration (a fibre flat) per science exposure during the night if needed. Relative flux calibration as a function of wavelength will be performed with the help of white dwarf stars and Gaia spectrophotometry, which will be available at the time 4MOST starts observing. A precision of the order of 10% in the continuum slope is expected.

For sky subtraction a fixed percentage of fibres will be allocated to empty sky regions. To monitor the quality and correctness of the data reduction process, radial velocity, flux, and telluric standard stars will be observed. Commissioning will be used to test the data reduction and analysis pipelines on real data.

Supplementary targets

Normal completeness requirements of surveys that are used for statistical inferences result in inefficiencies in assigning all fibres to targets once most targets have been completed. In order to increase the 4MOST scientific outcome, the science team will add targets to fill these unscheduled fibres. Supplementary targets are targets that come with no completeness requirements and no guarantee that any one in particular will be observed. These extra targets are only added to avoid empty fibres. Therefore the observed number of such targets in any region will depend on the availability of main survey targets and observing time in a given area. Community proposals for supplementary targets will also be accepted.

Poor observing conditions programme

When observing conditions are too poor to carry out the normal survey programme, 4MOST will switch to a dedicated poor conditions programme. Poor conditions are, for instance: twilight, full moon without a visible Milky Way, seeing full width half maximum (FWHM) > 1.5 arcseconds, and cirrus. The optimal boundaries for each of these constraints that are required to switch to this special

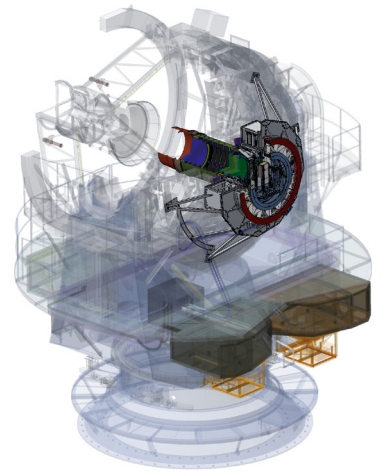

4MOST Focal Surface Units

- 1 Wide Field Corrector Front Baffle
- 2 Wide Field Corrector Lens L1
 $\text{\O} = \sim 950 \text{ mm}$
 Mass $\sim 120 \text{ kg}$
- 3 Wide Field Corrector Tube including internal baffles
- 4 Wide Field Corrector Lens L2a + L2b
 $\text{\O} = \sim 650 \text{ mm}$
 Mass $\sim 47 \text{ kg} + 33 \text{ kg}$
- 5 Wide Field Corrector Lens L3a + L3b
 $\text{\O} = \sim 650 \text{ mm}$
 Mass $\sim 68 \text{ kg} + 44 \text{ kg}$
- 6 Wide Field Corrector Lens L4
 $\text{\O} = \sim 650 \text{ mm}$
 Mass $\sim 44 \text{ kg}$
- 7 Atmospheric Dispersion Corrector rotation mechanisms
- 8 Fibre Positioner electronics boxes
- 9 Acquisition & Guiding and Wave Front Sensing
 $2\text{k} \times 2\text{k}$ technical cameras with pick-off prisms
- 10 Fibre Positioner
 2436 Science spines
 12 Guide spines
- 11 Cassegrain Cable Wrap including master-slave and safety mechanisms
- 12 Fibre Feed and Services
 2436 Science fibres
 Power, control, and coolant lines

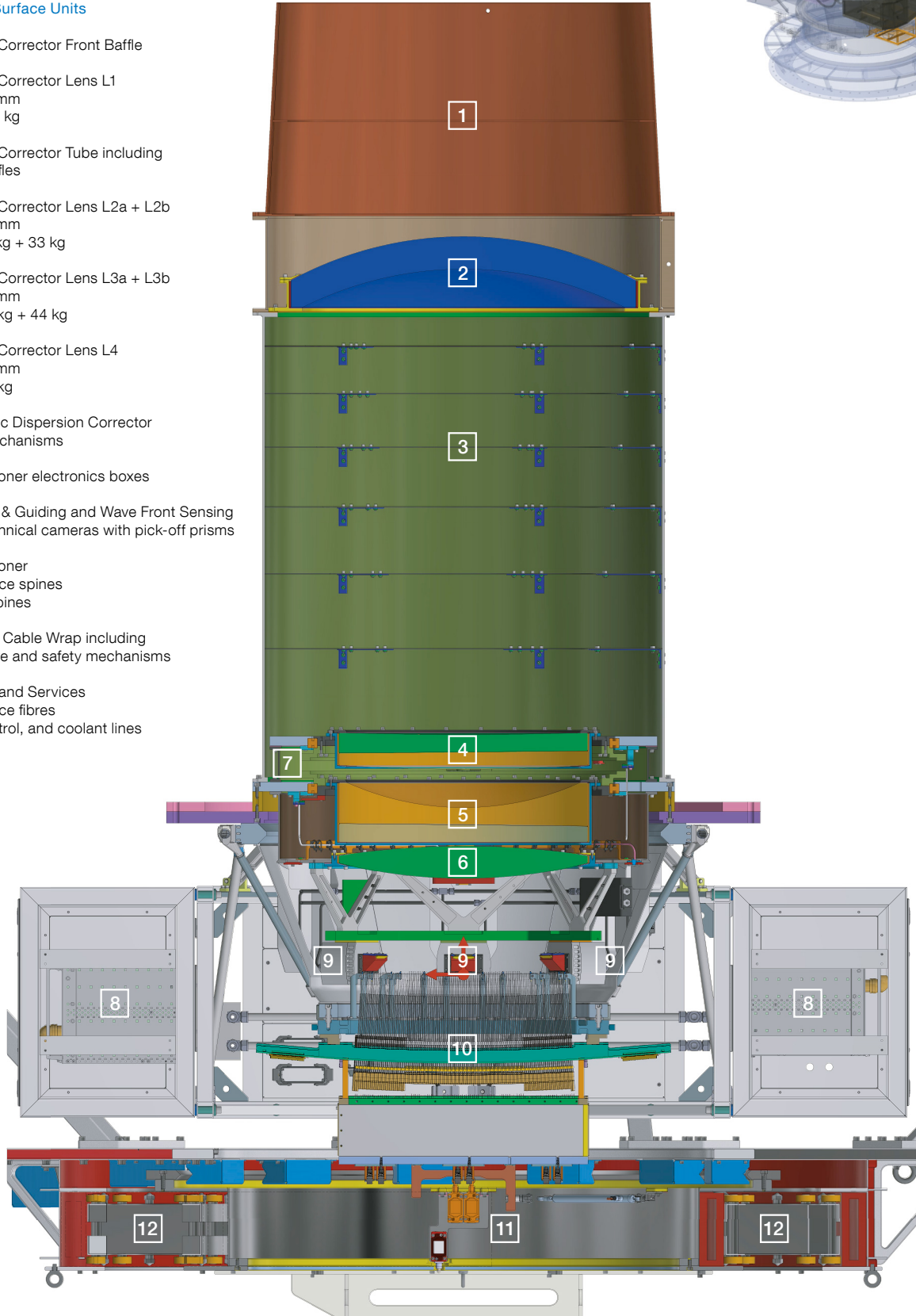

4MOST Consortium Survey 1: The Milky Way Halo Low-Resolution Survey

Amina Helmi¹
 Mike Irwin²
 Alis Deason³
 Eduardo Balbinot¹
 Vasily Belokurov²
 Joss Bland-Hawthorn⁴
 Norbert Christlieb⁵
 Maria-Rosa L. Cioni⁶
 Sofia Feltzing⁷
 Eva K. Grebel⁸
 Georges Kordopatis⁹
 Else Starkenburg⁶
 Nicholas Walton²
 C. Clare Worley²

¹ Kapteyn Instituut, Rijksuniversiteit Groningen, the Netherlands

² Institute of Astronomy, University of Cambridge, UK

³ Department of Physics, Durham University, UK

⁴ Sydney Institute for Astronomy, University of Sydney, Australia

⁵ Zentrum für Astronomie der Universität Heidelberg/Landessternwarte, Germany

⁶ Leibniz-Institut für Astrophysik Potsdam (AIP), Germany

⁷ Lund Observatory, Lund University, Sweden

⁸ Zentrum für Astronomie der Universität Heidelberg/Astronomisches Rechen-Institut, Germany

⁹ Observatoire de la Côte d'Azur, Nice, France

The goal of this survey is to study the formation and evolution of the Milky Way halo to deduce its assembly history and the 3D distribution of mass in the Milky Way. The combination of multi-band photometry, Gaia proper motion and parallax data, and radial velocities and the metallicity and elemental abundances obtained from low-resolution spectra of halo giants with 4MOST, will yield an unprecedented characterisation of the Milky Way halo and its interface with the thick disc. The survey will produce a volume- and magnitude-limited complete sample of giant stars in the halo. It will cover at least 10 000 square degrees of high Galactic latitude, and measure line-of-sight velocities with a precision of 1–2 km s⁻¹ as well as metallicities to within 0.2 dex.

Scientific context

Halo stars in the Milky Way spend significant amounts of time at large distances from the Galactic centre, hence their trajectories are sensitive to the mass distribution of the dark matter halo. Our survey, the 4MOST Consortium Milky Way Halo Low-Resolution Survey, is therefore key for measuring the full mass distribution of the Milky Way. In conjunction with the more local Milky Way Halo High-Resolution Survey, and the detailed surveys of the Milky Way disc and bulge carried out in the 4MOST Milky Way Disc And BuLgE Low- and High-Resolution Surveys (4MIDABLE-LR and 4MIDABLE-HR), it also aims to determine the complete merger and assembly history of the Galaxy (see Christlieb et al., p. 26; Chiappini et al., p. 30 and Bensby et al., p. 35).

The Galactic halo contains large amounts of substructure at distances beyond 20 kpc, discovered with wide-field photometric surveys more than 10 years ago (Belokurov et al., 2006). At these large distances, debris is more spatially coherent because the mixing timescales are long. With the release of the Gaia astrometric data in April 2018 and the availability of 6D phase-space information, it has been demonstrated that the inner halo is dominated by merger debris from a single object as large as the Small Magellanic Cloud at the time of accretion (Helmi et al., 2018; Belokurov et al., 2018). Beyond our Galactic neighbourhood, the chemical characterisation of which is the focus of the Milky Way High-Resolution Survey (Christlieb et al, p.26), there is still much to learn. To make significant progress and pin down the full merger history of the Milky Way we require spectroscopic data of distant halo stars over a large portion of the sky that can be combined with the parallax and proper motion information from Gaia.

Most current mass estimates of the Milky Way have relied on small numbers of tracers, and hence are likely subject to bias given the substructures present in the halo. The existing data sets contain, at most, 150 objects beyond 50 kpc (dwarf galaxies, globular clusters, halo stars; see, for example, the review article by Bland-Hawthorn & Gerhard, 2016). Gaia will provide partial data for a few

thousand stars out to 30–60 kpc, including tangential velocities with errors between 5 and 50 km s⁻¹ depending on their apparent magnitudes. 4MOST will push the radial velocities much further, down to $G \sim 20$ magnitudes at 1–2 km s⁻¹ accuracy. Our survey will also measure line-of-sight velocities for stars at the tip of the red giant branch up to a distance of 250 kpc, and the rarer carbon and other asymptotic giant branch stars to 1 Mpc. Not only will the estimates of the total mass of the Galaxy be much more precise, but also its 3D distribution (density and shape) will be within reach using various dynamical modelling techniques.

Our survey will also detect faint stellar streams and any substructures in a combined abundance-kinematic space. In particular, the follow-up of thin streams will allow us to pin down the lumpiness of the dark matter halo and to constrain its nature (Erkal & Belokurov, 2016; Bonaca et al., 2018). All of these measurements will thus lead to strong constraints on cosmological models.

A significant by-product of determining the metallicity distribution function across the halo will be the discovery of extremely metal-poor stars, which will be the focus of further, more detailed follow-up, most likely using facilities other than 4MOST.

Specific scientific goals

The specific goals of our survey are:

- Determining the density profile, shape and characteristic parameters of the dark matter halo of the Milky Way — including testing alternative theories of gravity such as Modified Newtonian Dynamics (MOND) — and possibly their evolution in time.
- Measurement of the perturbations induced by clumps on the spatial and kinematic properties of cold streams leading to constraints on the mass spectrum of perturbers and on the nature of dark matter.
- Quantifying the amount of kinematic substructure as a function of distance and location on the sky. This will allow the discovery of substructures, new dwarf galaxies and other low surface brightness objects, the characterisation

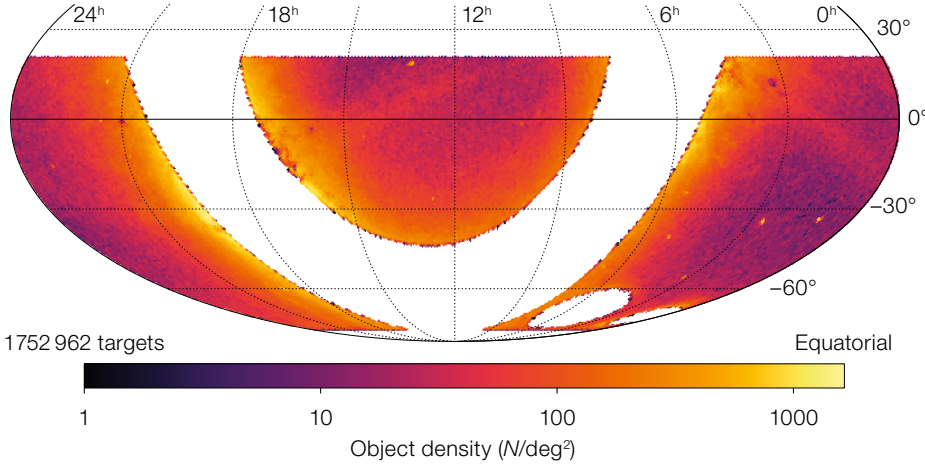

Figure 1. Input catalogue density distribution for the goal survey area of the Milky Way Halo Low-Resolution Survey. The stars shown here have been extracted from Gaia Data Release 2 (Gaia collaboration et al., 2018) and satisfy the following criteria: $-10 < G + 5 \log_{10}(\text{proper motion}) < 10$, $\text{parallax} - 2\sigma_{\text{parallax}} < 0.2$; $0.55 < G - G_{\text{RP}} < 0.8$ magnitudes, and $15 < G < 20$ magnitudes. This leads to a sample of approximately 2 million objects satisfying the declination range and $|b| > 20$ degrees, after pruning out 5- and 10-degree radius regions around the Small and Large Magellanic Clouds, respectively. Detailed coordination with the 4MOST Consortium Magellanic Cloud Survey (see Cioni et al., p. 54) will be carried out to ensure a smooth transition between the surveys, as well as refinement of the target selection criteria. Notice the Sagittarius streams and other halo over-densities in this version of the input catalogue for our survey. The goal survey area is $-80 < \text{dec} < +20$ degrees, however, it should be noted that the baseline survey for 4MOST is between $-70 < \text{dec} < +5$ degrees, and hence targets outside this footprint are less likely to be observed (see Guiglion et al., p. 17).

of their properties and their relation to the build-up of the halo.

- Characterisation of the metallicity and elemental abundance distribution (mostly magnesium and iron) throughout the halo, and also of each of the individual structures discovered. This will yield enhanced samples of objects with very low metallicities or peculiar elemental abundances for more detailed follow-up, complementing the 4MOST Consortium Milky Way Halo High-Resolution Survey (Christlieb et al., p. 26) which focuses on the halo near the Sun. Such samples should constrain the properties and yields of the first generation of stars (Population III).
- Characterisation of the stellar halo-thick disc interface from overlap with the 4MIDABLE-LR survey (Chiappini et al., p. 30) with the aim of jointly constraining the temporal assembly and evolution of the thick disc and inner halo.

Science requirements

The survey we propose will lead to a sample comprising on the order of 1.5 million giant stars in the halo (mainly K giant stars but also including the rarer A stars, particularly blue horizontal branch stars, together with M giant stars and carbon stars) across the virial volume of the Milky Way, with kinematics precise to $1\text{--}2 \text{ km s}^{-1}$ and overall metallicities precise to ≤ 0.2 dex. This means observing all giant stars in the halo in the magnitude range $15 \leq G \leq 20$ magnitudes, including those in the lower density regions of halo dwarf galaxies and globu-

lar clusters. This magnitude range overlaps at the bright end with the Milky Way Halo High-Resolution Survey, which not only provides cross-checks on derived stellar properties, but also ensures full linkage between local and distant halo populations. Since the halo density is low, a wide-field instrument like 4MOST is essential to cover a large area in a reasonable time. The depth of our survey is perfectly suited to the goals, and matches exactly the depth reached with Gaia with useful proper motion information. The strongest constraints on the mass distribution come from streams covering large angles on the sky, again pushing for large area surveys. For stars with higher signal-to-noise ($S/N > 25$ per \AA) useful constraints on the α -element abundances ($[\alpha/\text{Fe}]$ with error ≤ 0.1 dex), will be obtained and these are very important to further aid subdividing and characterising halo substructures (see for example, Hayes et al., 2018; Helmi et al., 2018).

The optimal streams for the determination of the Milky Way gravitational potential (mass, shape, time evolution and granularity) are thin and cold, and typically originate in objects with stellar mass smaller than a few times $10^5 M_{\odot}$. Models of galaxy formation (Cooper et al., 2010) predict about 50–100 such thin streams observable down to a G magnitude ~ 20 , across a 10 000 square degree region of the sky, and there may be many more from disrupted globular clusters (Bonaca et al., 2014; and see Malhan et al., 2018 for the first detections with Gaia DR2). A smaller area leads to a significant loss

in the number of such streams and this impacts the determination of the mass distribution in the halo (Sanderson et al., 2015).

Radial velocity estimates will generally be obtained from a combination of the Mg b triplet (Mgb) and the near-infrared Ca II triplet (CaT) regions, which both contain sets of strong absorption lines, also easily detectable in stars with low metallicity. The velocity precision has to be $1\text{--}2 \text{ km s}^{-1}$ in order to measure the mean velocity in a field to approximately 500 m s^{-1} , which promises excellent constraints on the mass distribution in the Milky Way, and the dark matter granularity imprinted in the velocities of stream stars (for example, Bonaca et al., 2018). We note that accurate constraints on the Galactic potential can be obtained even if only limited proper motion information is available. If narrow streams are not distributed isotropically on the sky, for example as a consequence of infall along filaments, it will be important to complement the kinematic maps of streams with those from field stars.

Target selection and survey area

The density of the stellar halo, and hence of the kinematic tracers, is low. Moreover, since the density profile of the halo drops

rapidly, these tracers are rare at large distances. The expected average source density is 100–200 stars per square degree at a G magnitude ~ 20 . A large survey area (minimum 10 000 square degrees; goal 150 000 square degrees) is also needed to find the rare, precious red giant branch stars near the virial radius of the Milky Way. Candidate halo giant stars will be selected on the basis of Gaia photometry, parallax and proper motion information possibly supplemented with photometry from ground-based imaging surveys (DES, SDSS, VST, PanSTARRS). Furthermore, we will also specifically target stars in streams known at the time of the survey, potentially down to the main-sequence turnoff to increase the number of objects and provide tighter constraints on the dynamics of the stream. Our aim is to target every star lying in a cold stream area in the available magnitude range, since we expect (field) contamination at a level of 70%–100%, depending on how the stars are pre-selected. Although Gaia will yield some useful prior constraints on the distances of stars in the inner halo, photometric distance estimates will need to be combined with the Gaia data both to improve the inner halo distances and to provide a distance proxy for the outer halo. Here in particular, the 4MOST spectra will be key. The spectra will be coupled with extant broadband photometry to derive photometric distances and accurate radial velocities for the halo star samples (for example, Xue et al., 2014). The same survey will also make full use of the combination of kinematic and positional information combined with chemical, i.e., $[\text{Fe}/\text{H}]$ and $[\alpha/\text{Fe}]$, signatures to characterise substructures at large radii, be they streams or dwarf galaxies.

The goal survey area ranges from declinations (dec) of $+20$ to -80 degrees and covers all right ascensions (RAs) satisfying Galactic latitudes $|b| > 20$ degrees. This yields some 4500 square degrees north of the celestial equator and around 12 500 square degrees south of the equator, giving a total of 17 000 square degrees. As mentioned previously, galaxy formation simulations suggest a minimum requirement for the halo survey area to be at least 10 000 square degrees, while a desirable goal would be to cover at least 15 000 square degrees.

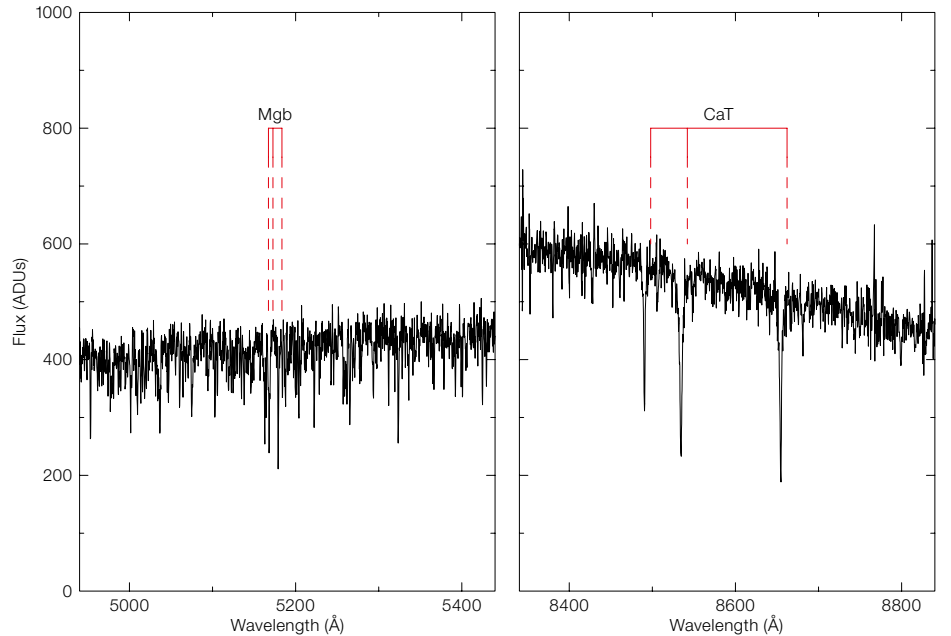

Spectral success criterion and figure of merit

The spectral success criterion of our survey will not be binary (i.e., passed/failed), but “fuzzy” since spectra with S/N below the boundary value are still useful for deriving radial velocities, albeit with a lower precision. For computing the spectral success value, we will employ a non-linear function $f(\text{S/N})$ that maps the S/N of each spectrum onto the value range $[0,1]$ and is defined to be 0.5 if the $\text{S/N} = 10$ per \AA in the continuum in the Mgb and CaT regions (compare Figure 2).

The survey figure of merit (FoM) is chosen to yield a high completeness per field with a large fraction of the stars satisfying well-defined S/N constraints over specific wavelength regions. The overall survey FoM is defined to be

$$\text{FoM} = \min\left\{1.0, \left[\frac{\sum A_i \min(CF_i/0.8, 1.0)}{15000.0}\right]\right\}$$

where A_i is the area of 4MOST field i in square degrees and CF_i the completeness fraction for a field, i.e., the fraction of stars satisfying the S/N constraints; 15 000 square degrees reflects our main survey area goal.

Figure 2. Example of a 1D-extracted spectrum of a halo K giant star ($g = 18.73$, $i = 17.51$ magnitudes) from a 4MOST simulated exposure of 3×1020 seconds in dark conditions. The stellar Mgb and CaT lines are blueshifted from their reference values by the high negative heliocentric velocity (-267 km s^{-1}) of the star. The average S/N in the continuum in these regions is around 25 \AA^{-1} . According to the study by the Galactic pipeline working group, these can reach a precision of $[\text{Fe}/\text{H}] \sim 0.15$ and $[\alpha/\text{Fe}] \sim 0.1$ dex.

References

- Belokurov, V. et al. 2006, *ApJL*, 642, L137
- Belokurov, V. et al. 2018, *MNRAS*, 478, 611
- Bland-Hawthorn, J. & Gerhard, O. 2016, *ARA&A*, 54, 529
- Bonaca, A. et al. 2014, *ApJ*, 795, 94
- Bonaca, A. et al. 2018, *arXiv:1811.03631*
- Cooper, A. P. et al. 2010, *MNRAS*, 406, 744
- Erkal, D. et al. 2016, *MNRAS*, 463, 102
- Gaia Collaboration et al. 2018, *A&A*, 616, A1
- Helmi, A. et al. 2018, *Nature*, 563, 85
- Hayes, C. R. et al. 2018, *ApJ*, 852, 49
- Malhan, K., Ibata, R. A. & Martin, N. F. 2018, *MNRAS*, 481, 3442
- Sanderson, R. E., Helmi, A. & Hogg, D. W. 2015, *ApJ*, 801, 98
- Xue, X.-X. et al. 2014, *ApJ*, 784, 170

4MOST Consortium Survey 2: The Milky Way Halo High-Resolution Survey

Norbert Christlieb¹
 Chiara Battistini¹
 Piercarlo Bonifacio²
 Elisabetta Caffau²
 Hans-Günter Ludwig¹
 Martin Asplund³
 Paul Barklem⁴
 Maria Bergemann⁵
 Ross Church⁶
 Sofia Feltzing⁶
 Dominic Ford⁶
 Eva K. Grebel⁷
 Camilla Juul Hansen⁵
 Amina Helmi⁸
 Georges Kordopatis⁹
 Mikhail Kovalev⁵
 Andreas Korn⁴
 Karin Lind⁵
 Andreas Quirrenbach¹
 Jan Rybizki⁵
 Ása Skúladóttir⁵
 Else Starkenburg¹⁰

¹ Zentrum für Astronomie der Universität Heidelberg/Landessternwarte, Germany

² GEPI, Observatoire de Paris, Université PSL, CNRS, France

³ Research School of Astronomy & Astrophysics, Australian National University, Canberra, Australia

⁴ Department of Physics and Astronomy, Uppsala universitet, Sweden

⁵ Max-Planck-Institut für Astronomie, Heidelberg, Germany

⁶ Lund Observatory, Lund University, Sweden

⁷ Zentrum für Astronomie der Universität Heidelberg/Astronomisches Rechen-Institut, Germany

⁸ Kapteyn Instituut, Rijksuniversiteit Groningen, the Netherlands

⁹ Observatoire de la Côte d'Azur, Nice, France

¹⁰ Leibniz-Institut für Astrophysik Potsdam (AIP), Germany

We will study the formation history of the Milky Way, and the earliest phases of its chemical enrichment, with a sample of more than 1.5 million stars at high galactic latitude. Elemental abundances of up to 20 elements with a precision of better than 0.2 dex will be derived for these stars. The sample will include members of kinematically coherent substructures, which we

will associate with their possible birthplaces by means of their abundance signatures and kinematics, allowing us to test models of galaxy formation. Our target catalogue is also expected to contain 30 000 stars at a metallicity of less than one hundredth that of the Sun. This sample will therefore be almost a factor of 100 larger than currently existing samples of metal-poor stars for which precise elemental abundances are available (determined from high-resolution spectroscopy), enabling us to study the early chemical evolution of the Milky Way in unprecedented detail.

Scientific context

Galaxy formation simulations predict that the halo of the Milky Way consists in part of stars that formed *in situ* and in part of stars that were accreted from smaller galaxies (for example, Pillepich et al., 2015). The simulations furthermore predict that the main external contribution to the build-up of the stellar halo came from the accretion of a few massive (i.e., 10^8 to $10^9 M_{\odot}$) luminous satellites which merged with our galaxy more than 9 Gyr ago (for example, De Lucia & Helmi, 2008). This has recently been confirmed observationally by the discovery of the stellar debris of the Gaia-Enceladus galaxy, which merged with the Milky Way 10 Gyr ago, and then had a mass of $2.4 \times 10^9 M_{\odot}$ (Helmi et al., 2018). Low-mass satellite accretion continues until the present day, especially in the outer halo, although at a much reduced rate. These small satellites are minor contributors to the stellar mass of the halo.

The remnants of such accretion events are kinematically coherent substructures in the Galactic halo. Some of them also remain spatially coherent, so that they can be detected in wide-field imaging surveys, and many have indeed been discovered during the last decade (for example, Malhan et al., 2018 and references therein).

Existing spectroscopic samples suggest that at low metallicities, the α -elements, Fe-peak elements and neutron-capture elements in stars of classical dwarf spheroidal galaxies (dSphs) and Milky

Way halo stars show very similar trends (for example, Mashonkina et al., 2017). In ultra-faint dwarf galaxies (UFDs), distinctly low abundances of neutron-capture elements and low [Sr/Ba] values (for example, Koch et al., 2013), and the abundance signature of a single *r*-process enrichment event (Ji et al., 2016) have been observed. Therefore, these abundance signatures can be used for associating kinematically identified groups of halo field stars with dSphs or UFDs. Furthermore, the location of the “knee” in the $[\alpha/\text{Fe}]$ vs. $[\text{Fe}/\text{H}]$ abundance ratio diagram^a (i.e., the value of $[\text{Fe}/\text{H}]$ at which supernovae of type Ia start to contribute significantly to the chemical enrichment of the galaxy, thereby decreasing $[\alpha/\text{Fe}]$) can be used to constrain the stellar mass of the host galaxy (for example Hendricks et al., 2014). With a large enough sample of halo stars it is therefore possible to identify the building blocks of the Galactic halo, determine their quantity and properties, and test numerical simulations of galaxy formation.

Additional significant contributions to the build-up of the Milky Way halo have been made by the accretion of stars from globular clusters (for example Martell et al., 2011). These stars can be identified in the halo field by their characteristic light element abundance ratios (Bastian & Lardo, 2018).

Our survey will also aim to significantly increase the sample of metal-poor stars (i.e., stars in which the abundances of elements heavier than helium are reduced by more than a factor of ten relative to the Sun) in the Galactic halo. These stars are tracers of the early chemical evolution of the Galaxy (Frebel & Norris, 2015). The abundances of the elements in their atmospheres provide us with information not only on the earliest phases of chemical enrichment of the Universe, but also on the nucleosynthetic processes contributing to the enrichment. In addition, they provide observational constraints on the physics of star formation processes in metal-poor environments and properties of the first generation of stars (for example, the initial mass function and rotation speeds).

Specific scientific goals

The goals of the 4MOST Milky Way Halo High-Resolution Survey are:

- identification and determination of the elemental abundance patterns of stars that (a) formed *in situ* in the Galaxy, (b) were contributed from a few major accretion events, or (c) were contributed by minor, low-mass accretion events;
- identification of stars that were accreted to the halo from globular clusters, and quantification of their contribution to the build-up of the halo;
- studying the earliest phases of chemical evolution of the Milky Way and the nucleosynthetic processes involved by means of very metal-poor (i.e., $[\text{Fe}/\text{H}] < -2.0$) halo stars.

To reach these goals, we plan to determine the abundances of 10–20 elements in more than 1.5 million stars at high galactic latitude; the number of elements will depend on the stellar parameters, including $[\text{Fe}/\text{H}]$. By applying our selection criteria (Table 1) to the Gaia DR2 mock stellar catalogue of Rybizki et al. (2018), we estimate that our current catalogue contains about 200 000 genuine halo stars. This is the number of stars needed for the characterisation of the 300–600 kinematically coherent groups of stars that are expected to be present in the Galactic halo from cosmological simulations (for example, Gomez et al., 2013), because several hundred stars per group are needed to accurately sample the multi-dimensional abundance space. Note that most dSphs experienced extended star formation histories, so a wide range in $[\text{Fe}/\text{H}]$ needs to be sampled.

We do not want to select these 200 000 genuine halo stars by kinematic criteria, to avoid kinematic biases in our sample. Furthermore, precise radial velocities cannot be acquired by the Gaia Radial Velocity Spectrometer for the majority of our stars, because most of them are too faint — Gaia will obtain radial velocities with a precision better than 1 km s^{-1} only for G dwarf and K giant stars brighter than $G = 12.3$ and 12.8 magnitudes (Vega), respectively. Therefore, the third component of their space motions will be known only *a posteriori*, once the 4MOST spectra have been obtained.

| Criterion # | Bright survey | Faint survey | Deep survey |
|---|---|----------------------|----------------------|
| 1 | $+20^\circ \geq \text{dec} \geq -80^\circ$ | | Selected areas |
| 2 | $ b > 20^\circ$ | | |
| 3 | $[\text{Fe}/\text{H}] < -0.5$ | | |
| 4 | $12.0 \leq G \leq 14.5$ | $14.5 < G \leq 15.5$ | $15.5 < G \leq 17.0$ |
| 5 | $0.15 \leq (G_{BP} - G_{RP})_0 \leq 1.10$ | | |
| 6 | $(1.10 < (G_{BP} - G_{RP})_0 \leq 1.60) \& (M_G < 3.5)$ | | |
| Total number of targets | 1 150 000 | 800 000 | 26 000 |
| Targets at $[\text{Fe}/\text{H}] < -2.0$ | 13 000 | 18 000 | 100 |

Table 1. Target selection criteria for the three sub-surveys. The criteria 5 and 6 select dwarf/sub-giant, and giant stars, respectively. The logical combination of the criteria is “1 and 2 and 3 and 4 and (5 or 6)”.

At the low-metallicity end, we will be able to increase the sample of halo stars with elemental abundances based on high-resolution (i.e., $R = \lambda/\Delta\lambda > 18\,000$) spectroscopy by almost two orders of magnitude. At the time of writing, the Stellar Abundances for Galactic Archaeology (SAGA)¹ database lists 323 such stars at $[\text{Fe}/\text{H}] < -2.0$ with available high-resolution spectra, while our target catalogue contains 31 000 stars in that metallicity range, of which we expect $\sim 24\,000$ to be observed.

Extrapolating from the currently existing samples, we estimate that we will find ~ 200 new stars at $[\text{Fe}/\text{H}] < -4.0$, compared to the 24 that are known today, according to the SAGA database. These stars are presumably second-generation stars; i.e., their elemental abundance patterns are the imprints of the supernova explosions of the first stars in the Universe. Therefore, we will be able to derive indirectly properties of the first generation of stars (including, for example, their mass distribution), and to infer information on the physics of star formation in low-metallicity environments. Furthermore, the larger sample will give us a chance of identifying objects that are too rare to be included in the currently existing samples.

Science requirements

Since the density of stars bright enough for high-resolution spectroscopy with a 4-metre telescope is low in fields at high galactic latitude, this survey needs large sky coverage. We are therefore aiming at a survey area of 14 000 square degrees.

At an average target density of about 450 dwarf and giant stars per 4.2 square degrees of the 4MOST field down to $G = 15.5$ magnitudes (but varying strongly with galactic latitude), this will lead to a sample of more than 1.5 million stars. Our current target catalogue covers 18 700 square degrees (see Figure 2), including a total of about 4 700 square degrees at declinations, $\text{dec} > +5$ degrees or $\text{dec} < -70$ degrees (i.e., outside the fiducial survey footprint, see Guiglion et al., p. 17). However, we expect that only a small fraction of these fields outside the fiducial footprint can be observed, because of unfavourable observing conditions (for example, higher airmass or prevailing northern winds at Paranal), and the total amount of observing time available in a five-year survey.

For characterising the abundance patterns, all the relevant element groups need to be covered, including the light elements (for example, C), α -elements (for example, Mg, Ca), and neutron-capture elements (for example, Ba, Sr, Eu). In the optical spectra of very metal-poor stars, there are very few absorption lines at $\lambda > 4500 \text{ \AA}$ (see Hansen et al., 2015 for a detailed study). For these stars, we will mostly rely on the spectra acquired with the blue arm of the 4MOST high-resolution spectrograph. However, valuable additional information can be derived, for example, from the Mg I b triplet lines covered by the green arm, and from the $\text{H}\alpha$ and the Li I 6707 \AA lines covered by the red arm. Furthermore, the green and red arm spectra of higher metallicity (i.e., $-2.0 < [\text{Fe}/\text{H}] < -0.5$) stars will contain many more detectable lines, which will increase the precision of the derived elemental abundances.

Elemental abundance ratios with a precision of $\sigma_{[\text{X}/\text{Y}]} < 0.2$ dex are typically needed to distinguish between different stellar populations, and to determine the

potential origin of the stars. For example, stars with $[\alpha/\text{Fe}] \sim 0.0$, which are characteristic of dwarf galaxies (for example, Tolstoy et al., 2009) — as opposed to the canonical $[\alpha/\text{Fe}] = +0.4$ in the Milky Way halo — can be recognised reliably only at this precision in abundance ratio measurement. The $[\alpha/\text{Fe}]$ ratios of the inner and outer halo are separated by only 0.1 dex (Nissen & Schuster, 2015), but several α -elements can be combined to increase the precision.

Information on the binary status of the targets of our survey is important for the interpretation of their elemental abundance patterns, since it provides constraints on the nucleosynthetic origin of, for example, the neutron-capture elements in the atmospheres of the observed stars. Therefore, we want as many targets as possible to be re-observed on timescales of months to years, so that radial velocity variations can be detected.

Target selection and survey area

The targets for our survey will be selected from the Gaia Data Release 3 catalogue, based on their apparent Gaia magnitude (G), de-reddened $G_{BP}-G_{RP}$ colour (i.e., $(G_{BP}-G_{RP})_0$), where G_{BP} and G_{RP} are the integrated Gaia Blue and Red Photometer magnitudes, respectively, and absolute G magnitude (M_G), determined using Gaia parallaxes (or upper limits). For the metallicity selection, we will use the best data available at the time the 4MOST survey starts; for example, from the SkyMapper survey (Casagrande et al., 2019), Gaia BP spectra, or at $\text{dec} > 0$ degrees from the Pristine survey (Starken et al., 2017). The selection criteria are summarised in Table 1.

Since we are targeting halo stars, we have restricted the survey footprint to galactic latitudes of $|b| > 20$ degrees, taking advantage of the fact that the high-resolution fibres of 4MOST will not be used by the extragalactic surveys. In the range $20 < |b| < 30$ degrees, there will be a significant overlap with the targets of 4MIDABLE-HR (Bensby et al., p. 35). The overlap is currently estimated to be about 440 000 stars, so a joint target catalogue will be created and observed spectra will be exchanged.

| Star type | S/N per pixel ^b in survey | | |
|------------------|--------------------------------------|-------|------|
| | Bright | Faint | Deep |
| Dwarf & subgiant | 50 | 25 | 25 |
| Giant | 30 | 15 | 15 |

Table 2. Spectral success criteria. The S/N is measured in the wavelength region 4261–4270 Å, which is free of strong spectral lines in the stellar parameter range covered by our survey. The criteria reflect the different science goals of the sub-surveys, as well as the different line strengths in dwarf and giant stars of a given metallicity.

Our metallicity cut ($[\text{Fe}/\text{H}] < -0.5$) will ensure that our survey will include the interesting metallicity range $-1.5 < [\text{Fe}/\text{H}] < -0.5$, over which the $[\alpha/\text{Fe}]$ abundance ratios allow us to discriminate between the inner and outer halo populations (Nissen & Schuster, 2010). On the other hand, the criterion removes stars of the disc populations in the Milky Way.

For harmonisation with the maximum total exposure times per high-galactic-latitude field needed by the low-resolution surveys, we have defined three sub-surveys: (1) a bright survey of stars in the range $12 \leq G \leq 14.5$ magnitudes, allowing us to acquire spectra with a signal-to-noise ratio (S/N) larger than 50 per pixel^b in the continuum at 4260 Å with 4MOST in less than 2 hours; (2) a faint survey ($14.5 < G \leq 15.5$ magnitudes); and (3) a deep survey ($15.5 < G \leq 17.0$ magnitudes). In the latter two sub-surveys, the S/N requirements are reduced by a factor of two with respect to the bright survey. The area of the deep survey will be aligned with the sky regions in which other 4MOST surveys will obtain longer exposures, for example, the WAVES-Wide and WAVES-Deep surveys. The fainter magnitude limit in these fields will allow us to observe giant stars at distances of up to 25 kpc, so the fraction of outer halo stars among our targets is expected to be significantly higher in these fields.

We note that the magnitude ranges of the 4MOST high- and low-resolution surveys of the Milky Way halo are complementary. In the former, the brighter magnitude limit will result in a sample dominated by the inner halo population, while the latter will focus on exploring the outer halo.

All three of our sub-surveys target dwarf, subgiant, and giant stars. The blue colour limit of $(G_{BP}-G_{RP})_0 = 0.15$ magnitudes is chosen to match the colours of 13-Gyr-old ultra-metal-poor (i.e., $[\text{Fe}/\text{H}] < -4.0$) stars near the main-sequence turnoff; the red limit of $(G_{BP}-G_{RP})_0 = 1.6$ magnitudes ensures that metal-poor K giant stars are included, while main-sequence stars of spectral type M or later are removed. To remove foreground K dwarf stars belonging to the Galactic disc populations, we have added an absolute magnitude criterion for the stars at $(G_{BP}-G_{RP})_0 > 1.1$ magnitudes. With that colour limit, metal-poor G dwarf stars are still included. The absolute magnitude criterion for giant stars is $M_G < 3.5$ magnitudes. A colour-magnitude diagram of the targets in a narrow range around $[\text{Fe}/\text{H}] = -1.0$ is shown in Figure 1.

Spectral success criteria and figure of merit

Our spectral success criteria are chosen such that precise (i.e., $\sigma_{[X/Y]} < 0.1-0.2$ dex) elemental abundances of up to 20 elements can be determined for the targets of the bright sub-survey, while for the fainter targets at least a rough characterisation of the abundance patterns of the stars will be possible by means of abundances of the most important elements with a typical precision of $\sigma_{[X/Y]} < 0.2-0.3$ dex, depending on the elements and the stellar parameters. This will make it possible to, for example, identify metal-poor stars enhanced in carbon, neutron-capture elements, or combinations thereof. Example spectra are shown in Figure 3, and the criteria are listed in Table 2.

The current definition of the figure of merit (FoM) of this survey increases linearly with the number of successfully observed targets, and it is 1.0 if 1.5 million stars have been observed successfully. However, we are considering implementing a numerical scheme that takes into account “partially successful” observations such as that outlined in the White Paper of the 4MOST Consortium Milky Way Halo Low-Resolution Survey (see Helmi et al., p. 23), for the reasons discussed there.

Figure 1. Colour-magnitude diagram of the targets of the three sub-surveys. We show stars at $[\text{Fe}/\text{H}] = -1.0 \pm 0.1$, taken from the Gaia DR2 mock stellar catalogue (Rybizki et al., 2018), and compare them with isochrones for $[\text{Fe}/\text{H}] = -1.0$ and ages 10, 12, and 13 Gyr. The numbers inside the panels are the distance ranges covered by the targets at the given absolute magnitude. The absence of stars on the subgiant branch (i.e., roughly in the absolute magnitude range $3 < M_G < 4$ magnitudes) is an artefact introduced by selecting only stars for which $[\text{Fe}/\text{H}]$ has been determined with a precision of better than 0.3 dex. Note that the $(G_{BP}-G_{RP})_0$ colours of main-sequence turnoff stars at $[\text{Fe}/\text{H}] = -4.0$ are considerably bluer than those of the stars shown here, hence our choice of a colour cut-off at $(G_{BP}-G_{RP})_0 = 0.15$ magnitudes.

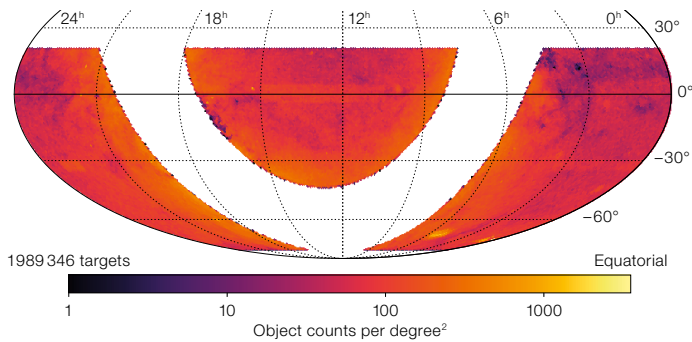
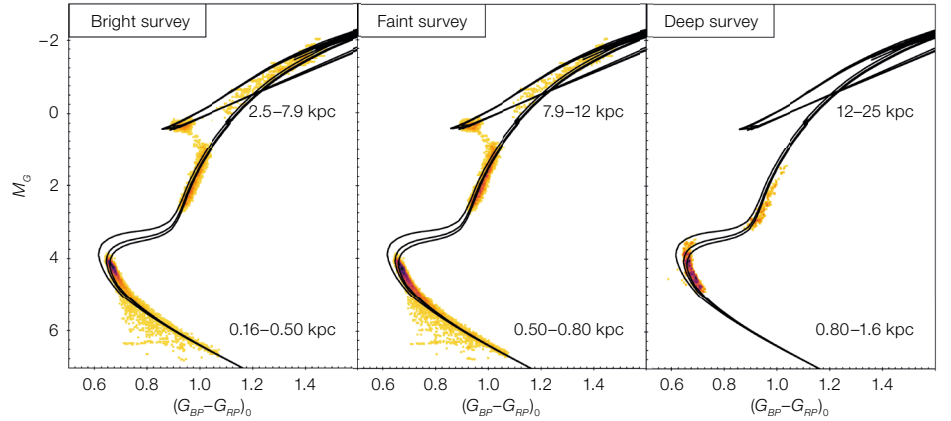

Figure 2. Combined target density of the three sub-surveys. The areas covered by our deep survey can be recognised by their slightly higher target densities compared to the combined target density of the other two sub-surveys, for example, at dec ~ 0 degrees and $10 < \text{right ascension} < 15$ hours, which is one of the WAVES-Wide fields (see WAVES White Paper of Driver et al., p. 46). Note that targets with dec $> +5$ and dec < -70 degrees have a smaller likelihood of being observed in the baseline survey strategy (see Guiglion et al., p. 17).

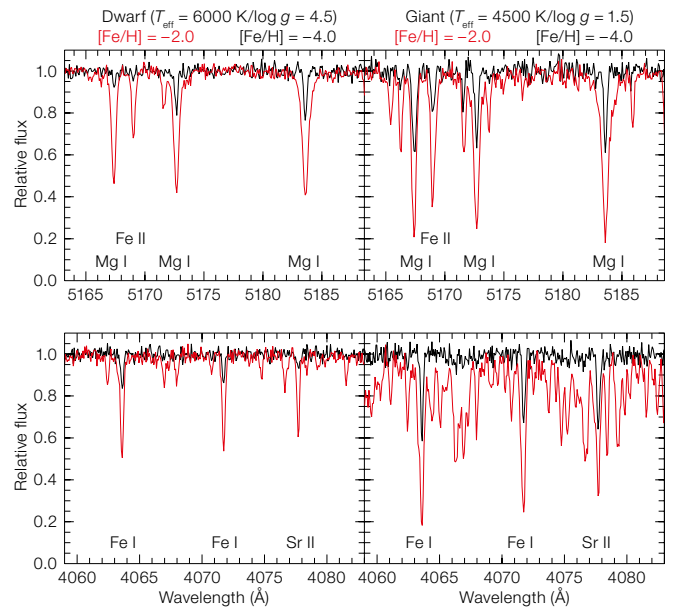

Figure 3. Synthetic spectra of a dwarf star (left panels) and a giant star (right panels) at the S/N required to reach the science goals of the bright survey (see Table 1). At that S/N, several Fe lines, as well as the Mg *b* triplet lines, are clearly detected even at $[\text{Fe}/\text{H}] = -4.0$.

Acknowledgements

This work is supported by Sonderforschungsbereich SFB 881 “The Milky Way System” (subprojects A3, A4 and A9) of the German Research Foundation (DFG), by the German Federal Ministry of Education and Research (BMBF) through Verbundforschungsprojekt 05A17VH4, by the Observatoire de Paris, and the project grant “The New Milky Way” from the Knut and Alice Wallenberg Foundation.

References

- Bastian, N. & Lardo, C. 2018, *ARA&A*, 56, 83
 Casagrande, L. 2019, *MNRAS*, 482, 2770
 De Lucia, G. & Helmi, A. 2008, *MNRAS*, 391, 14
 Frebel, A. & Norris, J. E. 2015, *ARA&A*, 53, 631
 Hansen, C. J. et al. 2015, *AN*, 336, 665
 Helmi, A. et al. 2018, *Nature*, 563, 85
 Hendricks, B. et al. 2014, *ApJ*, 785, 102
 Ji, A. et al. 2016, *ApJ*, 830, 93
 Koch, A. et al. 2013, *A&A*, 554, A5
 Malhan, K. et al. 2018, *MNRAS*, 481, 3442
 Martell, S. L. et al. 2011, *A&A*, 534, A136
 Mashonkina, A. 2017, *A&A*, 608, A89
 Nissen, P. E. & Schuster, W. J. 2010, *A&A*, 511, L10
 Pillepich, A. et al. 2015, *ApJ*, 799, 184
 Rybizki, J. et al. 2018, *PASP*, 130, 074101
 Starkenburg, E. et al. 2017, *MNRAS*, 471, 2587
 Tolstoy, E. et al. 2009, *ARA&A*, 47, 371

Links

- ¹ Stellar Abundances for Galactic Archaeology Database: <http://sagadatabase.jp/>

Notes

^a $[X/Y] = \log_{10}(N_X/N_Y)_* - \log_{10}(N_X/N_Y)_\odot$, where N_X and N_Y are the number densities of the elements X and Y, respectively.

^b For a conversion from S/N per pixel into S/N \AA^{-1} , a factor of 3.3 has to be applied (see 4MOST overview paper by de Jong et al., p. 3).

4MOST Consortium Survey 3: Milky Way Disc and Bulge Low-Resolution Survey (4MIDABLE-LR)

Cristina Chiappini¹
 Ivan Minchev¹
 Else Starkenburg¹
 Friedrich Anders²
 Nicola Gentile Fusillo³
 Ortwin Gerhard⁴
 Guillaume Guiglion¹
 Arman Khalatyan¹
 Georges Kordopatis⁵
 Bertrand Lemasle⁶
 Gal Matijevic¹
 Anna Barbara de Andrade Queiroz¹
 Axel Schwöpe¹
 Matthias Steinmetz¹
 Jesper Storm¹
 Gregor Traven⁷
 Pier-Emmanuel Tremblay³
 Marica Valentini¹
 Rene Andrae⁸
 Anke Arentsen¹
 Martin Asplund⁹
 Thomas Bensby⁷
 Maria Bergemann⁸
 Luca Casagrande⁹
 Ross Church⁷
 Gabriele Cescutti¹⁰
 Sofia Feltzing⁷
 Morgan Fouesneau⁸
 Eva K. Grebel⁶
 Mikhail Kovalev⁸
 Paul McMillan⁷
 Giacomo Monari¹
 Jan Rybizki⁸
 Nils Ryde⁷
 Hans-Walter Rix⁸
 Nicholas Walton¹¹
 Maosheng Xiang⁸
 Daniel Zucker¹²
 and the 4MIDABLE-LR Team

¹ Leibniz-Institut für Astrophysik Potsdam (AIP), Germany

² Departament de Física Quàntica i Astrofísica, Universitat de Barcelona, Spain

³ Department of Physics, University of Warwick, UK

⁴ Max-Planck-Institut für extraterrestrische Physik, Garching, Germany

⁵ Observatoire de la Côte d'Azur, Nice, France

⁶ Zentrum für Astronomie der Universität Heidelberg / Astronomisches Rechen-Institut, Germany

⁷ Lund Observatory, Lund University, Sweden

⁸ Max-Planck-Institut für Astronomie, Heidelberg, Germany

⁹ Research School of Astronomy & Astrophysics, Australian National University, Canberra, Australia

¹⁰ Osservatorio Astronomico di Trieste, INAF, Italy

¹¹ Institute of Astronomy, University of Cambridge, UK

¹² Department of Physics and Astronomy, Macquarie University, Sydney, Australia

The mechanisms of the formation and evolution of the Milky Way are encoded in the orbits, chemistry and ages of its stars. With the 4MOST Milky Way Disk And BuLgE Low-Resolution Survey (4MIDABLE-LR) we aim to study kinematic and chemical substructures in the Milky Way disc and bulge region with samples of unprecedented size out to larger distances and greater precision than conceivable with Gaia alone or any other ongoing or planned survey. Gaia gives us the unique opportunity for target selection based almost entirely on parallax and magnitude range, hence increasing the efficiency in sampling larger Milky Way volumes with well-defined and effective selection functions.

Scientific context

Observations of star-forming regions suggest that stars are born in groups that possess a high degree of chemical homogeneity. Large-scale galactic dynamical processes (spiral arms, the central bar, mergers) affect these stellar aggregates kinematically but not chemically. Comparison between dynamical models of the Galaxy and the observed velocity field for a densely populated homogeneous disc area will allow us, for the first time, to unambiguously quantify the structure of the present-day bar, spiral arms, and asymmetries across the disc mid-plane. By combining this information with accurate elemental abundances and ages, we will reconstruct the enrichment of the Galaxy as a function of Galactic radius and time. With its high multiplex power, 4MOST will allow us to view the Milky Way as a whole.

With the Low-Resolution Spectrograph^a (LRS) of 4MOST we can study the origin and evolution of essentially all the dominant stellar components of the Milky Way:

the chemically and structurally defined thin and thick discs, and the bulge. The area covered by the 4MIDABLE-LR, as well as by the 4MOST Milky Way Disc And BuLgE High-Resolution survey for brighter stars (4MIDABLE-HR) will be large enough to also enable a comprehensive study of the disc/bulge, disc/halo, and bulge/halo interfaces for the first time — the latter two in collaboration with the 4MOST Consortium Milky Way Halo LR Survey.

Specific scientific goals

Our main goals are:

- To better understand the current Milky Way disc structure and dynamics (bar, spiral arms, vertical structure, stellar radial migration, merger history).
- To study the chrono-chemo-dynamics of the disc, which, when combined with the above will allow us to recover the disc evolutionary history.
- To better understand the formation of the Milky Way bulge/bar using both chemical and kinematical information.
- To study the inner disc/bulge and disc/halo interfaces by covering a large area and ensuring high-quality chemical and kinematical information.

These goals could be summarised as one main goal — to provide a detailed chrono-chemo-kinematical extended map of our Galaxy and the largest Gaia follow-up down to $G = 19$ magnitudes (Vega). The complex nature of the disc components (for example, large target densities and highly structured extinction distribution in the Milky Way bulge and disc area), as well as the nature of the open questions addressed above, prompted us to develop a survey strategy with five main sub-surveys that are tailored to answer the main science questions, while taking full advantage of the Gaia data.

The main sub-surveys are:

1. **Extended Solar Neighbourhood (ESN)**
 - The aim of this sub-survey is to study in detail the chemistry and velocity substructure in a disc volume for which Gaia provides the most precise parallaxes ($d < 2$ kpc). Because we select stars that are fainter than those that have been targeted for spectro-

copy by Gaia, we target this region with many more and different tracers, including sub-giant stars (~20%) which are suitable for accurate age determination. Additionally, we add elemental abundances not obtainable from Gaia spectra, such as the n -capture elements Ba and Sr. Constraining the dynamical and chemical state in this nearby region will drastically improve our understanding of the influence that the bar, spiral arms, and external perturbations (for example, from the Sagittarius dwarf spheroidal galaxy) have on the disc dynamics and stellar radial migration (Minchev, Chiappini & Martig, 2013). This is our brightest sub-survey and the most densely sampled region.

2. **Dynamical disc (Dyn)** — This sub-survey targets a dense disc sample to detect velocity resonance structures, stellar streaming, and disc ringing in order to better understand the current structure and dynamics of the Milky Way disc (Minchev, 2016). Comparing the velocity field in different parts of the Galaxy will allow us to unambiguously determine the physical mechanisms perturbing the Milky Way in a way that is not possible with smaller or patchy survey volumes. It is therefore crucial that we observe a dense sample over multiple (four to five) disc scale-lengths, leveraging the unique capabilities of 4MOST, and produce an extended map to facilitate comparisons between the well-studied Milky Way and galaxies in general.
3. **Faint dynamical disc (Fdyn)** — This sub-survey has an overall goal similar to that of the Dynamical disc sub-survey, but with the explicit aim of studying the stellar disc to its edge, and also at the other side of the Galaxy (out to $d \sim 30\text{--}40$ kpc) providing mainly radial velocity information rather than elemental abundances for these faint targets. This will be a unique capability of 4MOST, even in the 2020s.
4. **Chemodynamical disc (Chem)** — Here we target a sparser sample as a subset of the Dyn sub-survey described above, to study the chemodynamical structure of the Milky Way disc in order to recover the evolutionary history of

the disc. Higher signal-to-noise (S/N) observations enable measurement of elemental abundances for many stars for iron, carbon, several alpha elements and iron-peak elements, lithium, sodium, and the n -capture elements Ba and Sr. Our data will allow us to constrain radial and vertical chemical gradients, as well as velocity dispersions as a function of stellar age when combined with sub-samples of stars for which ages can be reliably determined (from asteroseismic measurements, or otherwise). The large sample of stellar spectra will also allow identification of stars that were born in now-dissolved star clusters and associations via chemical labelling and kinematics, when the cluster chemistry and/or kinematics are sufficiently different from the field population. Moreover, it may lead to the serendipitous discovery of extra-tidal stars around surviving clusters, imposing constraints on dynamical mass loss.

5. **Bulge/Inner Galaxy (BIG)** — To better understand the formation of the Milky Way bulge/bar region and to study the inner disc/bulge/halo interfaces, this sub-survey will map the inner 4–5 kpc of the Galaxy, encompassing the full bar length and peanut thickness, which is still poorly covered by other spectroscopic surveys (Barbuy et al., 2018). This will certainly be a legacy survey, as we aim to provide the largest coverage of the inner disc/bulge volume, focusing on the interplay of all different Galactic components in this region. BIG will fully complement the surveys with the Multi-Object Optical and Near-infrared Spectrograph (MOONS), the Apache Point Observatory Galaxy Evolution Experiment (APOGEE), Sloan Digital Sky Survey V, and the 4MOST Milky Way Disc And Bulge High-Resolution (4MIDABLE-HR) survey. We will be taking advantage of complementary photometry from the ESO Vista Variables in the Via Lactea Surveys (VVV and VVVx) in the JHK_s bands and of the Blanco DECam (Dark Energy Camera) Bulge Survey (BDBS) which covers 200 square degrees of the southern bulge in the $ugrizY$ bands and will be publically available by the end of 2019.

Whilst most of our survey is carried out under bright sky conditions, some dark and grey time will be used for this sub-survey. Moreover, in a joint effort with S4, we plan a 4MOST southern bulge deep-field sub-survey with a grid of pointings in the region $-8 < l < 8$ degrees and $-10 < b < -4$ degrees to be observed for 8 hours each. This will allow us to extend the LR coverage down to $G = 18.5\text{--}19.0$ magnitudes in these fields, hence complementing our main survey in the $16 < G < 17$ magnitude range.

In parallel with our main sub-surveys, we will have the following six sub-surveys targeting specific classes of stars. These can all be pursued simultaneously and efficiently thanks to the multiplexing capabilities of 4MOST and the fact that they consist of targets sparsely distributed over the footprint of the main surveys.

6. **Very metal-poor stars** — These are important tracers of the early evolution of the Galaxy. We will select these targets in the disc and inner Galaxy from additional photometric surveys (SkyMapper and the Pristine survey), and from APOGEE. For the latter targets spectroscopy is available, but for this type of target the 4MOST optical wavelength coverage rather than the (near-) infrared APOGEE wavelength region is necessary to obtain accurate elemental abundance information and study their chemical pattern. Our very metal-poor sub-survey complements the 4MOST Consortium Milky Way Halo High-Resolution Survey, which is also pre-selecting metal-poor targets, as we are probing fainter targets with the LRS and are looking in the inner Galaxy and in the disc footprint. Some overlap is desired for calibration purposes.
7. **White dwarfs** — This sub-survey will complement the Gaia mission and other Galactic sub-surveys enabling the use of white dwarfs as tracers of the star formation history in the disc and halo, which can help to disentangle different scenarios of stellar radial migration. Additionally, these observations will provide key constraints on the nature of SN Ia progenitors and the evolution of planetary systems. The goal is to determine atmospheric compositions, radial velocities, and

precise spectroscopic temperatures and surface gravities, which, in turn, will allow us to determine accurate stellar masses and ages for all targeted white dwarfs.

8. **Compact X-ray emitting binaries** — This sub-survey addresses the high-energy output of the Milky Way and the evolution of close binary stars. We aim to disentangle accreting and non-accreting sources, and to discriminate between magnetic and non-magnetic binaries, both on the basis of their emission line spectrum in the active state (for example, Schwobe, 2018). Input sources will be drawn from the eROSITA point-source catalogue.
9. **Cepheids** — Classical Cepheids have well-determined ages (~20–250 Myr). They are intrinsically bright, thus allowing studies of the recent Milky Way evolution to large Galactic radii. Type II Cepheids are old (> 10 Gyr) and trace the chemical thick disc and its interface with the bulge. Targets will be selected from the ESA Gaia data releases, the Optical Gravitational Lensing Experiment (OGLE), and VVVX. The goal is to obtain homogeneous radial velocities and metallicities/elemental abundances for these unique tracers down to fainter magnitudes than those achieved with 4MIDABLE-HR.
10. **Asteroseismology targets** — A follow-up will be performed of all targets in the survey footprint with asteroseismic information from the CoRoT, K2, TESS and PLATO missions, allowing a much more precise determination of elemental abundances, stellar parameters, distances, and ages for these stars (for example, Valentini et al., 2018). These stars are, therefore, also key targets for survey calibration. With the exception of TESS, objects will be distributed in specific fields (from 2.5 square degrees for CoRoT, to 100 square degrees for K2, and 2250 square degrees for PLATO). The brightest of these targets will function as a bad weather programme.
11. **Hot subdwarfs** — The goal of this sub-survey is to compile, classify and analyse the first unbiased all-sky sample of hot subdwarf stars pre-selected

on the basis of data from Gaia and photometric surveys from the ground (Geier et al., 2018). Hot subdwarfs are the helium-burning stripped cores of red giants and are likely formed via diverse close binary evolution channels such as stable mass transfer, common envelope ejection and mergers. They are key objects to study interactions between low-mass stars as well as stars and sub-stellar objects. Hot subdwarf binaries qualify as progenitors of type Ia supernovae and calibration sources for gravitational wave detectors. They are chemically peculiar and several classes of pulsators have been discovered which are well suited for asteroseismic analyses. This survey will allow us to perform the first population study of these objects.

Science requirements

By using the large wavelength coverage and resolution of the LRS, this survey will deliver not only radial velocities with the high precision of 1–2 km s⁻¹, but also chemical information, providing individual elemental abundances for iron-peak, α - and n -capture elements, C, Na, and Li (which is detectable in LR only in giants). Depending on the element, elemental abundances will have a precision of 0.1–0.2 dex when sufficient S/N in the continuum is reached in the relevant wavelength regime.

Target selection and survey area

A careful target selection with a selection function that can be well modelled is crucial for our survey. A large down-sampling is necessary to select ~15 million targets from over 300 million Gaia targets in the magnitude range we will explore in 4MIDABLE-LR. Should targets just be picked randomly, we would predominantly select nearby disc stars, which would greatly hamper the effectiveness of our survey to research the Milky Way as a galaxy.

To ensure a homogeneous volume distribution for the main disk coverage, for the sub-catalogues defined in the ESN, Dyn, Chem, and BIG sub-surveys above we use the parallax (ρ) measured by Gaia

and its uncertainty in a probabilistic approach, where stars are selected randomly in a given HEALPix^{2,b} area such that the probabilistic line-of-sight parallax distribution has the shape of $1/\rho^4$, implying a distance distribution of the form d^2 . The ESN is constrained to a cylinder of radius $d = 2$ kpc and height $|z| = 2$ kpc, centred on the Sun. The Dyn and Chem sub-catalogues, which share the same volume, are selected from a cylinder with base $2 < d < 15$ kpc and height $|z| = 2$ kpc. The resulting hole around the Sun is complemented by the ESN catalogue. The BIG catalogue covers the volume defined by $|l| < 30$ degrees and $|b| < 20$ degrees, and $4 < d < 15$ kpc. Given the uncertainties in the measurements of parallaxes, leakage of targets outside these boundaries is both expected and desired.

Our target selection thus balances the need to sample the full Galactic disc, with an attempt to be as unbiased and efficient as possible. Therefore, for the main sub-surveys we foresee a selection based purely on apparent magnitude, parallax, and parallax uncertainties with no additional colour cuts. For some of the smaller sub-surveys there might be colour cuts as they target specific stellar populations. The faint dynamical disc includes a colour selection to target red giant branch stars similar to the selection performed in the 4MOST Consortium Survey Milky Way Halo Low-Resolution Survey.

We intend to use the latest Data Release from the Gaia mission at the time of final 4MOST catalogue submission; the preliminary catalogue that we present here is based on the currently available DR2 (Gaia Collaboration, Brown et al., 2018). An overview of the magnitude range per sub-survey is given in the second column of Table 1.

Unless otherwise mentioned in the first column of Table 1, all sub-surveys cover an area that is all-sky as observed by 4MOST, restricted in declination from $-80 < \text{dec} < 20$ degrees. The areas of $\text{dec} > 5$ degrees and $\text{dec} < -80$ degrees are outside the fiducial survey area and may not get completed (see Guiglion et al., p. 17). As expected, the density of targets is larger along the disc plane (see Figure 1). Areas with extinction so large that the target density is less than the

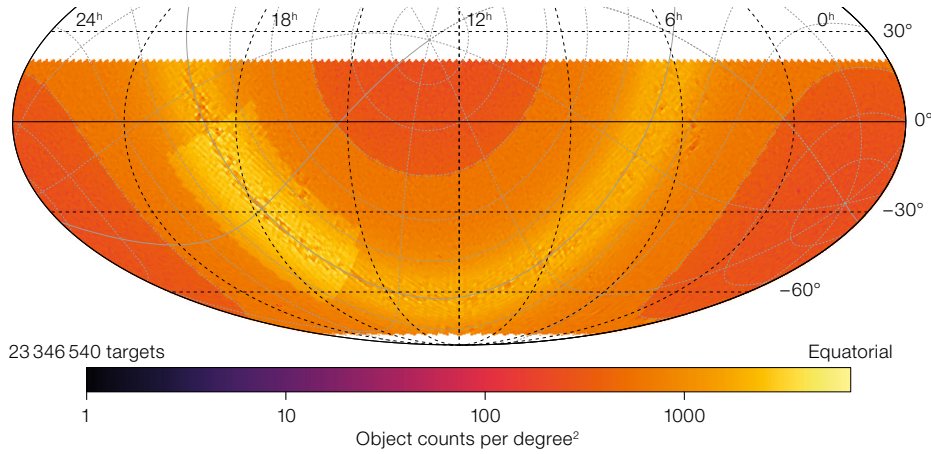

Figure 1. Illustration of the target density of the main sub-surveys in equatorial coordinates. All current catalogues and figures might be subject to change with the further development of our target selection criteria, a better understanding of the interplay of all surveys together, and the implementation of later Gaia data releases. Areas with high extinction will be de-prioritised because the target density drops below the 4MOST fibre density and only nearby targets are observable in these regions. Note that targets with $\text{dec} > +5$ and $\text{dec} < -70$ degrees have only a smaller likelihood of being observed in the fiducial survey strategy (see Guiglion et al., p. 17).

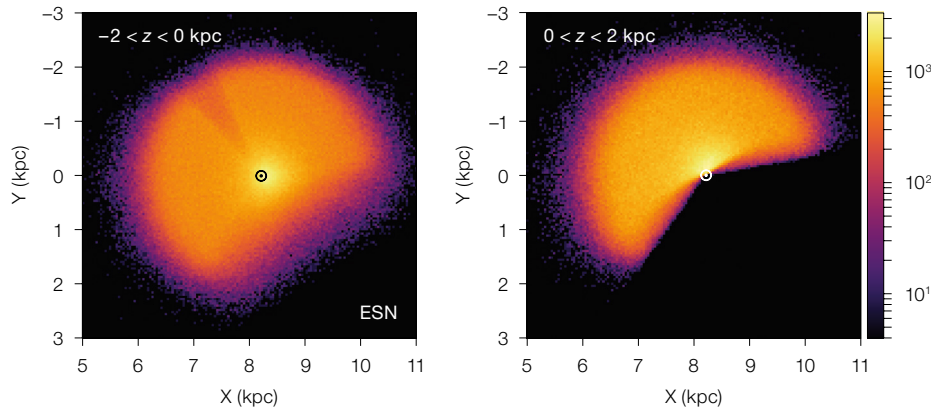

Figure 2. Target density distributions of the current definition of the Extended Solar Neighbourhood (ESN) catalogue using distance $d = 1/p$ for stars below (left) and above the disc mid-plane (right). The selection ensures an almost homogeneous distribution within a cylinder of radius $d = 2$ kpc and height $|z| = 2$ kpc, centered on the Sun. The Galactic centre is at $(x,y) = (0,0)$. The asymmetry between the two plots is due to the restriction in dec of the region of the sky that is observable with 4MOST.

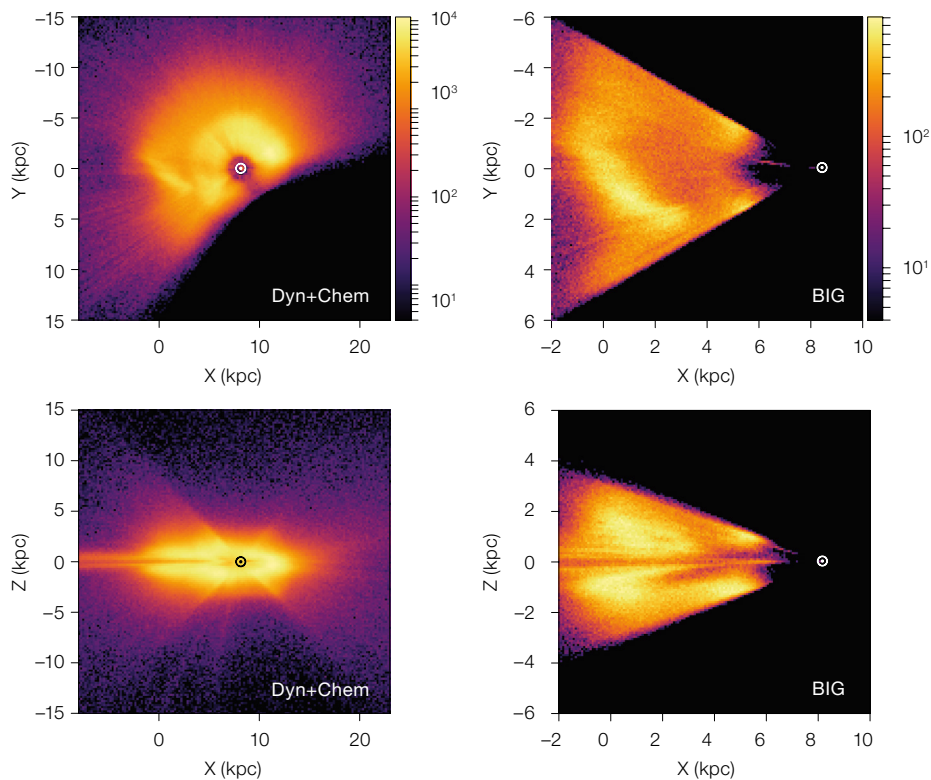

Figure 3. Left column: Face-on (top) and edge-on (bottom) target density distributions of the current disc catalogues. The dynamical (Dyn) and chemodynamical (Chem) disc surveys cover the same area and magnitude range but have different requirements for SNR (see Table 1). The Galactic centre is at $(x,y) = (0,0)$. The artefact at $|b| = 45$ degrees is due to our selection of a cylinder with base $2 < d < 15$ kpc and height $z = 2$ kpc. The resulting hole around the Sun is complemented by the ESN catalogue. Right column: Same as left, but for the Bulge/Inner Galaxy (BIG) catalogue, where our selection is in the volume defined by $|l| < 30$ degrees, $|b| < 20$ degrees, $4 < d < 15$ kpc. For both catalogues we take parallax uncertainties into account and require a homogeneous volume density. Star Horse distance estimates (Anders et al., in preparation; Queiroz et al. 2018) are used for calculating x , y , and z coordinates. The BIG catalogue clearly shows the presence of the bar (Anders et al., in preparation; Queiroz et al. in preparation).

available LRS 4MOST fibres will be avoided. Figures 2 and 3 illustrate that, despite being based on a relatively simple selection of apparent G -magnitude and parallax only (including uncertainties and flags), the resulting distribution of targets in the x - y - z plane in the main sub-surveys is balanced and sufficiently smooth. In Figure 3, we perform the test of resulting

| Sub-survey name | Gaia (G magnitude) | Spectral success criteria | | | N_{\min} | N_{goal} |
|--|--------------------|--|------------|-----------|-------------------|-------------------|
| | Interval | Minimum S/N \AA^{-1} at wavelength interval | | | FoM = 0.5 | FoM = 1.0 |
| Extended Solar Neighbourhood | 14–16.5 | 40 at blue | 50 at MgCa | 20 at Li | 2.5×10^6 | 4.5×10^6 |
| Dynamical Disc $ b < 30^\circ$ | 14–18 | 12 at CaT | 15 at Mgb | – | 3.5×10^6 | 4.5×10^6 |
| Faint Dynamical Disc $ b < 15^\circ$ | 18–19 | 12 at CaT | 15 at Mgb | – | 1.5×10^5 | 2.8×10^5 |
| Chemodynamical Disc $ b < 30^\circ$ | 14–18 | 40 at blue | 50 at Mgb | 20 at Li | 1.5×10^6 | 2.5×10^6 |
| Inner Galaxy $ l < 30^\circ$, $ b < 20^\circ$ | 16–17 | 40 at blue | 50 at Mgb | 20 at Li | 8×10^5 | 1×10^6 |
| Southern Bulge Deep $ l < 8^\circ$, $-10^\circ < b < -4^\circ$ | 17–18.5 | 40 at blue | 50 at Mgb | – | 1.2×10^5 | 1.4×10^5 |
| Very metal-poor stars | 14–18.5 | 40 at blue | 50 at Mgb | 20 at Li | 1.3×10^5 | 2.0×10^5 |
| White Dwarfs | 14–20 | 30 at blue | 30 at Mgb | 30 at CaT | 1.7×10^5 | 2.0×10^5 |
| Compact X-ray Binaries | 16–22 | 5 at blue | 50 at MgCa | 5 at CaT | 7.5×10^3 | 1.5×10^4 |
| Cepheids | 16–20.5 | 35 at MgCa ($G < 18$) | – | 10 at CaT | 1.7×10^3 | 2.3×10^3 |
| Asteroseismic targets | 4–16 | 40 at blue | 50 at Mgb | – | – | 2.0×10^5 |
| Hot subdwarfs | 8–19 | 30 at blue | 30 at Mgb | 30 at CaT | – | 2.5×10^4 |

Table 1. This table provides key information for each of the sub-surveys. Although the information given here reflects the philosophy of the sub-surveys, the exact numbers are subject to change as the target selection advances further in preparation for 4MOST operation. All sub-surveys target the full sky observed by 4MOST, unless specific limits are given in the first column in Galactic longitude (l) and latitude (b). The second column lists the magnitude range for targets in Gaia G-band. The next three columns show the requested minimum S/N per \AA for a successfully observed target and the wavelength region(s) — up to three — where this is measured (abbreviated; see text for details). The final two columns list the minimum number of targets successfully observed to reach a FoM of 0.5 for the sub-survey, and the goal number of targets, defining a FoM of 1.0.

homogeneous disc coverage of targets in our Dyn, Chem, and BIG input catalogues using distances obtained with the Bayesian Star Horse code (Queiroz et al., 2018; Anders et al., in preparation), as the targets are too far out to rely on $d = 1/p$ only to calculate distances. However, we stress that these Star Horse distance values are not used in the selection itself.

Spectral success criteria

The spectral success criteria are defined by the median S/N ratio per \AA in the continuum over a wavelength interval. For the different sub-surveys, different wavelength regions are used for this calculation, depending on the spectral features that are important for the science case. The spectral criteria per sub-survey are given in Table 1; a maximum of three spectral success criteria can be used per sub-survey, as given in the subsequent columns. The wavelength regions are as follows:

- Blue: 4500–4700 \AA ;

- Mgb: 5140–5200 \AA ;
- MgCa: 5140–6450 \AA ;
- Li: 6670–6740 \AA ;
- CaT: 8350–8850 \AA .

The figure of merit (FoM) for each sub-survey is described by the ratio of the number of targets successfully observed (N_{obs}) relative to the minimum number of targets and the goal (N_{\min} and N_{goal} respectively; see Table 1). Up to N_{\min} the relation is linear such that it reaches a figure of merit of 0.5 when N_{\min} targets are successfully observed. Thereafter it follows a square root function until it reaches a value of 1 when N_{obs} equals N_{goal} . The input catalogues all contain a larger density of targets than N_{goal} , to provide operational flexibility. We additionally require a relatively homogeneous coverage of the footprint for our sub-surveys, not allowing for any holes in the footprint that exceed a few square degrees.

Where possible, we favour an observation strategy that allows each field to be observed at least twice with at least a year in between the two observations. This will provide additional information on which stars are in binary systems with detectable radial velocity variability on these timescales. However, in fields with many faint Cepheid targets this strategy is not favourable, since these variable stars will need to be observed consecutively.

Acknowledgements

Cristina Chiappini acknowledges support from DFG Grant CH1188/2-1 and from ChETEC COST

Action (CA16117), supported by COST (European Cooperation in Science and Technology). Else Starkenburg gratefully acknowledges funding by the Emmy Noether program from the Deutsche Forschungsgemeinschaft (DFG). Bertrand Lemasle acknowledges support from the Sonderforschungsbereich SFB 881 “The Milky Way System” (sub-projects A5) of the German Research Foundation (DFG). Sub-survey #7 is funded under the European Union’s Horizon 2020 research and innovation programme no. 677706 (WD3D).

References

- Barbuy, B., Chiappini, C. & Gerhard, O. 2018, ARAA, 56, 223
- Gaia collaboration, Brown, A. et al. 2018, A&A, 616, 1
- Geier, S. et al. 2018, arXiv:1810.09321
- Miglio, A. et al. 2017, Astronomische Nachrichten, 338, 644
- Minchev, I. 2016, Astronomische Nachrichten, 337, 703
- Minchev, I., Chiappini, C. & Martig, M. 2013, A&A, 558, A29
- Schwope, A. 2018, A&A, 619, A62
- Valentini, M. et al. 2018, arXiv:1808.08569

Links

- ¹ ESA-Gaia mission: <http://sci.esa.int/gaia/>
- ² HEALPix: <https://healpix.jpl.nasa.gov/>

Notes

^a $R > 5000$ (typically $R \sim 6500$; see de Jong et al., p. 3) is mid-resolution, giving more than twice the spectral resolution of other large low-resolution spectroscopic surveys, for example, the Sloan Digital Sky Survey extension for Galactic Understanding and Exploration (SEGUE) and the Large Area Multi-Object fibre Spectroscopic Telescope (LAMOST).

^b HEALPix is an acronym for Hierarchical Equal Area isoLatitude Pixelization of a sphere, a pixelisation procedure that produces a subdivision of a spherical surface in which each pixel covers the same surface area as every other pixel.

4MOST Consortium Survey 4: Milky Way Disc and Bulge High-Resolution Survey (4MIDABLE-HR)

Thomas Bensby¹
 Maria Bergemann²
 Jan Rybizki²
 Bertrand Lemasle³
 Louise Howes¹
 Mikhail Kovalev²
 Oscar Agertz¹
 Martin Asplund⁴
 Paul Barklem⁵
 Chiara Battistini⁶
 Luca Casagrande⁴
 Cristina Chiappini⁷
 Ross Church¹
 Sofia Feltzing¹
 Dominic Ford¹
 Ortwin Gerhard⁸
 Iryna Kushniruk¹
 Georges Kordopatis⁹
 Karin Lind^{2,5}
 Ivan Minchev⁷
 Paul McMillan¹
 Hans-Walter Rix²
 Nils Ryde¹
 Gregor Traven¹



the Milky Way requires large observational datasets of stars via which these quantities can be determined accurately. This is the science driver of the 4MOST Milky Way Disc And Bulge High-Resolution (4MIDABLE-HR) survey: to obtain high-resolution spectra at $R \sim 20\,000$ and to provide detailed elemental abundances for large samples of stars in the Galactic disc and bulge. High data quality will allow us to provide accurate spectroscopic diagnostics of two million stellar spectra: precise radial velocities; rotation; abundances of many elements, including those that are currently only accessible in the optical, such as Li, s-, and r-process; and multi-epoch spectra for a subsample of stars. Synergies with complementary missions like Gaia and TESS will provide masses, stellar ages and multiplicity, forming a multi-dimensional dataset that will allow us to explore and constrain the origin and structure of the Milky Way.

Scientific context

One of the key questions in astrophysics is to understand the assembly history and evolution of the Milky Way, as our understanding of galaxy formation in the Universe — be it using observations or models — is only as good as our knowledge of our own Galaxy. This requires large datasets that provide reliable physical characterisation of stars across the full Hertzsprung-Russell diagram, including precise velocities, ages, multiplicity, rotation, and elemental abundances for all nucleosynthesis channels. This is the main goal of the 4MIDABLE-HR survey.

It has been established from star counts that the Galactic disc has two components, the thin and thick discs (Gilmore & Reid, 1983). This morphological dichotomy could be related to the distinct elemental abundance trends observed in the solar neighbourhood, as well as in the inner and outer regions of the Galactic disc (for example, Bensby et al., 2014; Hayden et al., 2015). Other studies, however, either find no clear separation in the local volume of about 1 kpc or place it at a different location in elemental abundance space (for example, Bergemann et al., 2014). Cosmological simulations of

galaxy formation suggest that galaxies like the Milky Way may experience various evolutionary histories, with or without multi-model structures arising in the elemental abundance plane (for example, Grand et al., 2018). On the other hand, radial migration of stars (for example, Schönrich & Binney, 2009) might have a strong impact on the disc morphology and on the observable distributions, such as the age-metallicity relationships and spatial distribution of elemental abundances. The mere presence and the size of the elemental abundance trend gap, its position in the age and abundance planes, and its relationship to stellar motions, are decisive constraints on the models of secular evolution and heating of the disc, as well as on the gas accretion and merger history of the Milky Way (for example, Rix & Bovy, 2013).

Further complexities are connected to our present understanding of the inner Galaxy. It has been established that it contains a boxy peanut-shaped bar that impacts the dynamical properties of the disc. Spectroscopic observations suggest that the bulge comprises a very complex pattern in the age-abundance plane, ranging from metal-rich young α -poor to metal-poor and very old α -rich stellar populations (for example, Ness et al., 2013; Bensby et al., 2017). It is not clear whether the bulge and the α -rich component of the disc share the same origin, or if this similarity is the consequence of high star formation efficiencies, but separate formation scenarios. Analysis of the photometric colour-magnitude diagrams suggests that the bulge has temporal properties (for example, Renzini et al., 2018) different from those revealed by spectroscopic observations of microlensed dwarf stars (Bensby et al., 2017). How much room is there for a classical bulge component made by mergers (for example, Barbuy et al., 2018)? A major challenge is to explain how all these constituents fit together and how they link to the chemo-dynamical structure of the Galactic disc and halo.

Disentangling all of these building blocks and the role that the different physical ingredients play in the formation of the Milky Way is hard. It requires a densely sampled homogeneous sample of stars with accurate elemental abundances,

The signatures of the formation and evolution of a galaxy are imprinted in its stars. Their velocities, ages, and chemical compositions present major constraints on models of galaxy formation, and on various processes such as the gas inflows and outflows, the accretion of cold gas, radial migration, and the variability of star formation activity. Understanding the evolution of

¹ Lund Observatory, Lund University, Sweden

² Max-Planck-Institut für Astronomie, Heidelberg, Germany

³ Zentrum für Astronomie der Universität Heidelberg / Astronomisches Rechen-Institut, Germany

⁴ Research School of Astronomy & Astrophysics, Australian National University, Canberra, Australia

⁵ Department of Physics and Astronomy, Uppsala universitet, Sweden

⁶ Zentrum für Astronomie der Universität Heidelberg / Landessternwarte, Germany

⁷ Leibniz-Institut für Astrophysik Potsdam (AIP), Germany

⁸ Max-Planck-Institut für extraterrestrische Physik, Garching, Germany

⁹ Observatoire de la Côte d'Azur, Nice, France

kinematics, and ages, requiring not only elemental abundances of α -elements, but also of all major nuclear channels: Li, C, N, O, the α -elements, the iron-group, and the neutron-capture r- and s-process elements. Only such a dataset will provide the requisite combination of constraints on the gas flows, star formation, and detailed chemical evolution of the Milky Way.

These are the observed quantities that 4MIDABLE-HR aims to provide for about two million stars in the Milky Way disc and bulge; stellar motions will be derived by combining accurate radial velocities from our spectra with proper motions and parallaxes from Gaia and special sub-surveys in 4MIDABLE-HR will address Cepheids, deep fields in the bulge, and the deep thick disc/halo field in the 4MOST Wide Area VISTA Extragalactic Survey viewing zone. These data will provide a unique treasure trove for high-precision stellar physics and will support the exploration of the Galaxy's evolution through: (i) a detailed investigation of the disc sub-structure throughout the Milky Way; (ii) quantifying the role of secular processes, such as the strength of radial migration, resolved by time and galactocentric radius; (iii) unveiling the stellar population content and its chemo-dynamical characteristics of the Galactic bulge; (iv) constraining the formation time and growth rate of the Galactic bar. In contrast to 4MIDABLE-LR (Chiappini et al., p. 30), the 4MIDABLE-HR Survey will focus on brighter stars and will aim to obtain spectra with sufficient quality and as many complementary diagnostics as possible from asteroseismology and astrometry, to provide a baseline against which the fundamental stellar parameters of all other 4MOST Galactic surveys can be assessed.

4MIDABLE-HR is unique amongst the other recent, ongoing, and planned high-resolution spectroscopic surveys in several respects. It is the largest optical high-resolution survey in terms of the number of targets, photometric depth, and survey area. Gaia-ESO is slightly deeper, but has patchy sky coverage, lower signal-to-noise ratio (S/N), and also many fewer stars. The WEAVE survey will not target the Galactic bulge region or areas close to the Galactic plane.

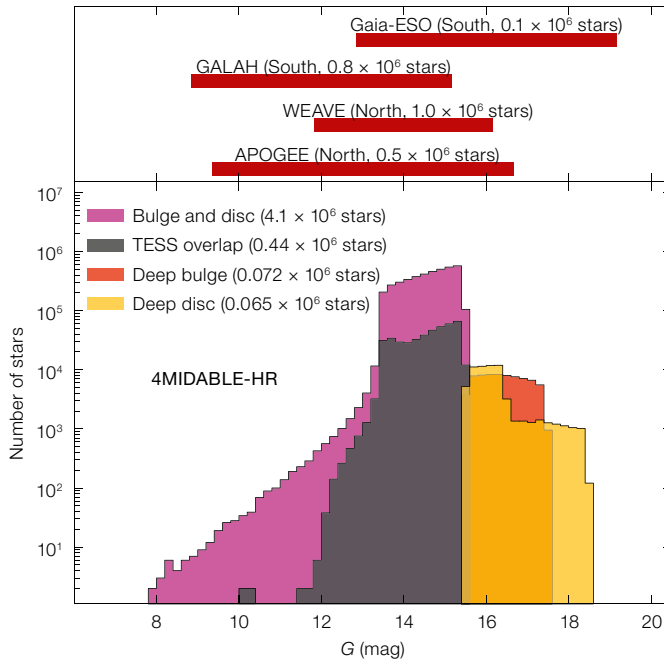

Figure 1. Magnitude distributions of our main bulge and disc sample and our two deep fields, one towards the bulge and one towards the 4MOST WAVES fields. The horizontal lines in the upper panel mark the magnitude ranges of selected high-resolution spectroscopic surveys, as indicated.

The focus of GALactic Archaeology with the HERMES spectrograph (GALAH) is mainly on the brighter targets, $V \lesssim 14$ magnitudes, and it does not probe such great distances into the Galaxy as we will do. The Apache Point Observatory Galactic Evolution Experiment (APOGEE) is an infrared survey and will not analyse neutron-capture elements — also, by probing to magnitudes $H < 14$, it will not have the depth of 4MIDABLE-HR. Figure 1 shows a comparison between 4MIDABLE-HR and these surveys.

Our spectra will also allow transformational studies of stellar physics thanks to the large sample of stars at all evolutionary stages, from the main-sequence, through the red bump to the core He-burning and AGB phases, and including pulsators like Cepheids. For 15% of our stars, asteroseismic information from the TESS exoplanet mission will be available. This information, combined with our spectroscopic characterisation, will not only allow us to put new constraints on the interior structure of stars, but also help to constrain the masses and ages of those stars and to assist planet-search programmes with characterising the planet-hosting stars. A significant fraction of stars are binaries, or even triples, allowing new constraints on the evolution and interaction of objects in multiple systems, especially when combined with binarity infor-

mation from Gaia astrometric data and photometric variability from Optical Gravitational Lensing Experiment (OGLE) and Large Synoptic Survey Telescope data.

Specific scientific goals

– What is the growth history of the Milky Way?

Our survey will give us direct information on the kinematics and detailed abundances in the outer disc and in the inner halo, which will help to constrain the masses and time of infall of the merging satellites. The signatures are very weak and require precise elemental abundances. In addition to the clustering in elemental abundance space, the merger history can be traced by physical overdensities and streams in the disc. Also, the velocity distribution in the vicinity of the Sun is not smooth, but contains a lot of kinematical overdensities (for example, Kushniruk et al., 2017). These could be due to dynamical resonances with the Galactic bar or spiral arms, dispersed open clusters, remnants of merged satellite galaxies, or even “ringing” signatures of a satellite galaxy analogous to the outer disc structures. The true nature of such structures can be revealed through detailed comparisons of the elemental abundances in the stars in the structures with measurements in the foreground

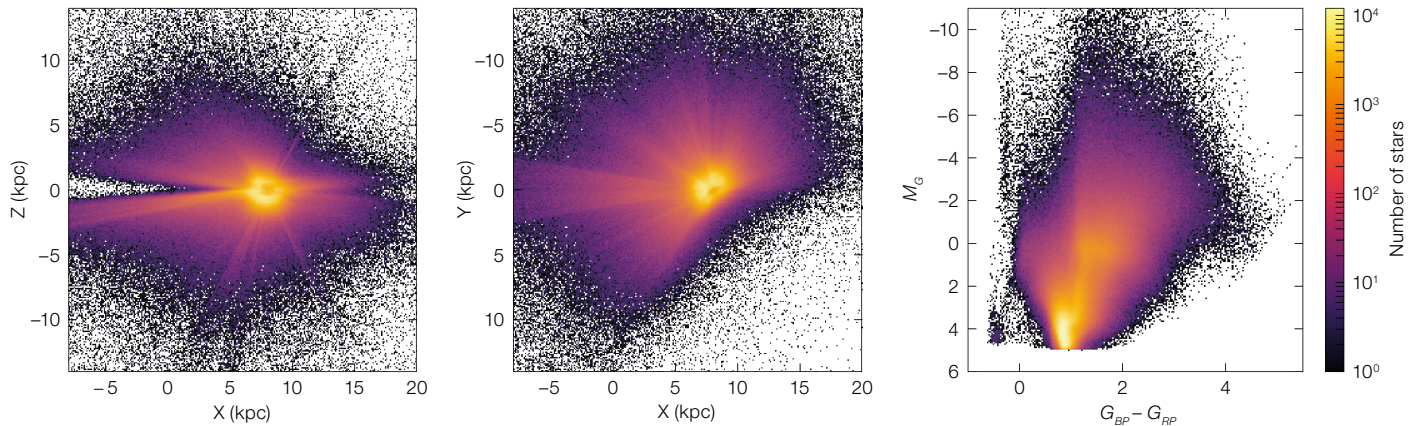

Figure 2. The left-most and middle plots show the distribution of the targets in the Galactic Cartesian x - y - z coordinate system of our input catalogue (with a bin size of 100×100 pc). The right-most plot shows a colour-magnitude diagram, using the Gaia G magnitudes and $G_{BP}-G_{RP}$ colours (not corrected for extinction).

and background stars in the Milky Way (Bergemann et al., 2018).

– Why does the Milky Way disc have such distinct abundance structure patterns? Are the thin and thick Galactic discs separate or are they a manifestation of observational biases? Could it be that the Milky Way only has one disc, but that radial migration has rearranged stars to create a sub-structure in the chemical and kinematic spaces? Can we confirm or rule out the hiatus in star formation between the two components? To address these important questions, we need large and unbiased samples of stars beyond the solar neighbourhood that cover a broad range of distances, from the inner to the outer regions of the Galactic disc.

– What is the Galactic bulge?

The Galactic bulge was for a long time considered to be a single population with fast formation and metal enrichment. However, recent studies have found that the bulge stars span a wide range of metallicities and ages. How much of the bulge could still be a classical bulge and not a buckled bar (pseudo-bulge)? What mass fraction in the bulge can be ascribed to halo stars? Can we explore the prominent X-shape of the bar and can we conclude — on the basis of ages and metallicities of the stars — when the buckling event happened?

Science requirements

With 4MIDABLE-HR we aim to distinguish stellar populations in the elemental abundance plane over three quadrants of the Galactic disc, probing as deep as 10 kpc from the Sun. For this we need a sample size of more than two million stars with elemental abundances that are accurate to well within 0.1 dex. The sample size is necessary because a detailed understanding of the Milky Way requires resolving the full kinematic and chemical distributions in all stellar populations at different positions in the Galaxy. To characterise the moments of the kinematic distributions of a single population at a given location, one needs of order 100 stars to get a statistically robust mean down to 10% of sigma (\sqrt{N}). The precision in elemental abundances allows us to cut the sample in 0.1-dex width in abundance space. Sampling the abundance plane in $[\alpha/\text{Fe}]$ versus $[\text{Fe}/\text{H}]$ meaningfully would thus require on the order of 50 abundance groups times 100 stars. The total sample size in this survey thus allows us to map out these populations at about 400 locations. This will enable us to distinguish the separation of elemental abundance trends between the α -poor and α -rich discs, and between the halo and the metal-poor disc, and to trace the position of the $[\alpha/\text{Fe}]-[\text{Fe}/\text{H}]$ “knee” from the solar neighbourhood, through the inner disc, and into the bulge (Hayden et al., 2011).

To resolve waves in the Galactic disc as seen by, for example, Antoja et al. (2018), one needs to resolve the mean velocity of the stars to better than 0.3 km s^{-1} , which, at the velocity dispersion of 50 km s^{-1} , requires 20 000 stars for each data point

and would allow us to resolve about 100 different points in angular momentum space or physical position space. We also want to map the age-velocity dispersion relation at different points in elemental abundance space and physical position space to shed light on the heating mechanisms in the Galactic disc in order to differentiate between possible high velocity dispersion at birth for older stars, secular heating by disc structure (for example, the Galactic bar, or spiral arms) or giant molecular clouds, and merger induced heating. To detect a merger, we can roughly estimate that we need to precisely track an increase of 5 km s^{-1} in the velocity dispersion over the course of roughly one billion years. This would require 5000 stars in each age bin or about 50 000 stars in total. These need to be sampled at 10 to 20 different Galactocentric radii and altitudes dissected in metallicity to pinpoint the radial pattern of heating. With these estimates, one would need on the order of 2.5 million stars to comprehensively address the formation of the Galactic components.

Target selection and survey area

The Bulge and Disc field star sub-survey

The 4MIDABLE-HR selection function has been designed to be simple and reproducible. The magnitude limit is set to $G = 15.5$ magnitudes, which allows us to obtain a high-quality spectrum with the required $S/N = 100$ per \AA in a two-hour exposure. To avoid cool main sequence stars an upper limit on the absolute magnitude is set to $M_G < 5$ magnitudes. Gaia

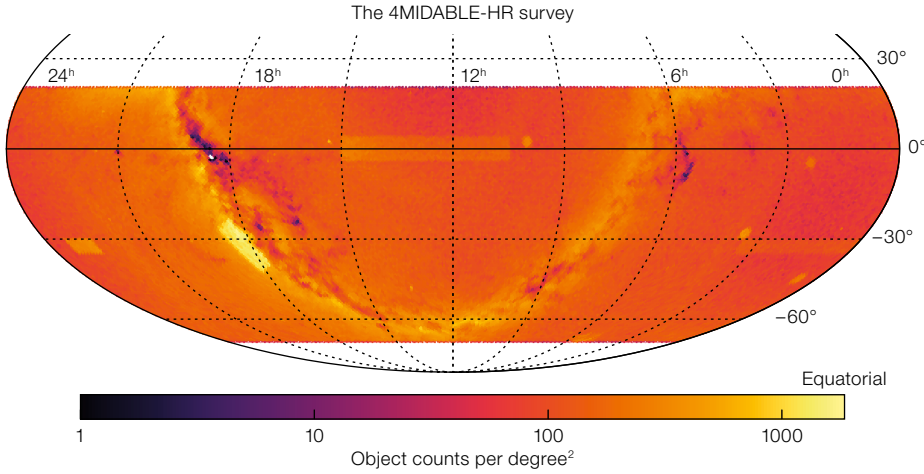

Figure 3. Density map of the input target catalogue. We aim to observe at least a random 50% of these targets. Note that the targets with $\text{dec} > 5$ degrees have a smaller likelihood of being observed in the fiducial survey strategy (Guiglion et al., p. 17).

parallaxes were used to estimate M_G . The range of sky declinations for 4MOST is set to $-80 < \text{dec} < +20$ degrees. We note that this area extends outside the fiducial survey footprint, which is restricted by prevailing northern winds, etc. (see Guiglion et al., p. 17).

Applying these simple cuts in dec , G , and M_G provides us with a sample of more than 21 million targets from the Gaia Data Release 2. This sample is downsized to fit into a five-year survey, and as we need to have about twice as many targets in the catalogue to allow for an efficient usage of the fibres, our target catalogue contains about 4.1 million targets. Figure 2 shows the physical positions and the colour-magnitude diagram of the stars in this catalogue.

Deep bulge fields

The main bulge and disc sub-survey extensively probes the inner disc region and its transition into the bulge region. It is, however, not deep enough to provide a statistically significant number of targets within the central few kpc. Therefore, to better probe the properties of the central part of the Galaxy we designed a bulge deep field sub-survey with pointed observations down to $G = 17.5$ magnitudes in a grid pattern in the southern bulge between $-8 < l < 8$ degrees and $-10 < b < -4$ degrees. Up to eight hours

will be spent in each of our 32 fields and the target catalogue contains about 72 000 targets.

Deep disc fields

To probe the vertical extent, the scale-height, and the interface between the disc and the halo, 4MIDABLE-HR will do deep observations in the footprints of the WAVES extragalactic survey that uses the low-resolution fibres. In the WAVES deep fields (about 65 square degrees) and in the WAVES wide fields (about 1300 square degrees) we will reach stars about ten times fainter and three times fainter, respectively, than the stars in our main disc and bulge catalogue. The catalogue contains about 65 000 stars. The positions of the WAVES fields can be found in Driver et al. (p. 46), but as stated therein, the exact location of the deep fields could be subject to change.

Bulge Cepheid survey

Classical Cepheids are young stars that trace the chemical composition of the interstellar medium. Type II Cepheids are post-horizontal-branch stars that trace the old population. They are present in the bulge, the thick disc, and probably the halo and allow 4MIDABLE-HR to study these Milky Way subsystems and their interfaces. The abundances of numerous elements can be derived from the analysis of Cepheid spectra. More importantly, their distances can be derived accurately (since they follow period-luminosity relations) even at large distances where Gaia parallaxes are less accurate. 4MIDABLE-HR will focus on Cepheids with $13.5 < G < 15.5$ magni-

tudes and our catalogue contains about 800 Cepheids towards the Galactic bulge.

Spectral success criteria and the figure of merit

The desired precision of 0.05 dex is achievable in most elemental abundance ratios such as the α -elements and most iron peak elements when $\text{S/N} > 100$ per \AA is reached (based on simulations with the 4MOST Galactic Pipeline). We have not imposed any constraints on reddening in our target catalogue, as the results from the pipeline indicate that the impact is negligible for the stars we aim to observe. It is, however, important to keep in mind that some rare-earth elements that can only be measured in the blue spectral region, which will be difficult to obtain for highly reddened spectra.

The S/N requirement will be measured in the continuum in the wavelength range 6190–6210 \AA , which is clean and free from strong spectral lines.

The figure of merit (FoM) is a measure of how successful the survey is, and for 4MIDABLE-HR, it is simply the ratio between the number of successfully observed targets and the 4.3 million stars in the input target catalogue. As long as stars are chosen and observed randomly from this catalogue, the survey will be regarded as successful when a $\text{FoM} = 0.5$ is reached.

Acknowledgements

This work was supported by the project grant “The New Milky Way” from the Knut and Alice Wallenberg Foundation.

References

- Antoja, T. et al. 2018, *Nature*, 561, 360
- Barbary, B. et al. 2018, *ARA&A*, 56, 223
- Bensby, T. et al. 2011, *ApJ*, 735, L46
- Bensby, T. et al. 2014, *A&A*, 562, A71
- Bensby, T. et al. 2017, *A&A*, 605, A89
- Bergemann, M. et al. 2014, *A&A*, 565, A89
- Bergemann, M. et al. 2018, *Nature*, 555, 334
- Grand, R. J. J. et al. 2018, *MNRAS*, 474, 3629
- Hayden, M. R. et al. 2011, *ApJ*, 808, 132
- Kushniruk, I. et al. 2017, *A&A*, 608, A73
- Ness, M. et al. 2013, *MNRAS*, 430, 836
- Renzini, A. et al. 2018, *ApJ*, 863, 16
- Rix, H.-W. & Bovy, J. 2013, *A&ARv*, 21, 61
- Schönrich, R. & Binney, J. 2009, *MNRAS*, 399, 3

4MOST Consortium Survey 5: eROSITA Galaxy Cluster Redshift Survey

Alexis Finoguenov^{1,2}
 Andrea Merloni¹
 Johan Comparat¹
 Kirpal Nandra¹
 Mara Salvato¹
 Elmo Tempel^{3,4}
 Anand Raichoor⁵
 Johan Richard⁶
 Jean-Paul Kneib⁵
 Annalisa Pillepich⁷
 Martin Sahlén⁸
 Paola Popesso⁹
 Peder Norberg¹⁰
 Richard McMahon¹¹
 and the 4MOST collaboration

¹ Max-Planck-Institut für extraterrestrische Physik, Garching, Germany

² University of Helsinki, Finland

³ Tartu Observatory, University of Tartu, Estonia

⁴ Leibniz-Institut für Astrophysik Potsdam (AIP), Germany

⁵ Laboratoire d'astrophysique, École Polytechnique Fédérale de Lausanne, Switzerland

⁶ Centre de Recherche Astrophysique de Lyon, France

⁷ Max-Planck-Institut für Astronomie, Heidelberg, Germany

⁸ Department of Physics and Astronomy, Uppsala universitet, Sweden

⁹ Physics Department, Technische Universität München, Germany

¹⁰ Department of Physics, Durham University, UK

¹¹ Institute of Astronomy, University of Cambridge, UK

Groups and clusters of galaxies are a current focus of astronomical research owing to their role in determining the environmental effects on galaxies and the constraints they provide to cosmology. The eROSITA X-ray telescope on board the Spectrum Roentgen Gamma observatory will be launched in 2019 and will have completed eight scans of the full sky when 4MOST starts operating. The experiment will detect groups and clusters of galaxies through X-ray emission from the hot intergalactic medium. The purpose of the 4MOST eROSITA Galaxy Cluster Redshift Survey is to provide spectroscopic redshifts of the optical counterparts to the X-ray emission from 40 000 groups and

clusters of galaxies so as to perform dynamical estimates of the total mass and to measure the properties of the member galaxies. The survey aims to obtain precise redshift measurements of the photometrically identified brightest cluster galaxies at redshift $z > 0.7$. At lower redshifts ($z < 0.7$) the programme aims to sample over 15 member galaxies per cluster and enable dynamical mass measurements to calibrate the clusters for cosmological experiments. At $z < 0.2$, eROSITA will also detect X-ray emission from galaxy groups and filaments. 4MOST spectroscopic data from the survey will be used for optical identification of galaxy groups down to eROSITA's mass detection limits of $10^{13} M_{\odot}$, as well as the detection of the largest filaments for pioneering studies of their X-ray emission.

Scientific context

The experimental measurement of the precise values of the cosmological parameters is the accepted way to progress the field of cosmology. These observational measurements include: measuring the fluctuations of the cosmic microwave background, which describe the inhomogeneities of the Universe at a redshift of 1100; geometric tests of the expansion of the Universe (using Supernovae and Baryonic Acoustic Oscillations); and the growth of large-scale structure throughout cosmic time. As outlined in the Dark Energy Task Force report (Albrecht et al., 2006), no single method can constrain the cosmological parameters precisely and a combination of methods is required.

The performance of a particular survey is judged by its ability to constrain the dark energy equation of state. The 4MOST spectroscopic survey will provide the validation of the cluster catalogue produced by the eROSITA survey, which tests cosmology through the growth of structure as reflected in the mass function of galaxy clusters, and it belongs to the highest tier of dark energy experiments. The 4MOST eROSITA Galaxy Cluster Redshift Survey is the only currently planned large-scale programme of this kind. Other redshift survey experiments, such as the Dark Energy Spectroscopic Instrument

(DESI) and the 4MOST Cosmology Redshift Survey, provide geometrical cosmological constraints, which are complementary; together they can constrain a larger variety of cosmological models.

Spectroscopic identification of galaxy clusters has been a cornerstone of all galaxy cluster surveys. Recently, this field has expanded due to developments on measurements of dynamical and caustic mass and the availability of precise memberships of cluster galaxies. In the last few years, a number of large-area galaxy cluster surveys have been carried out. The pioneering work on this has been done within the Sloan Digital Sky Survey SDSS-IV survey (Clerc et al., 2016), with a goal to follow up on 4000 clusters. A much larger demand on cluster follow-up is set by the eROSITA survey, and the goal of the 4MOST cluster survey is to follow up as many as 40 000 groups and clusters of galaxies, the precise details depending on the performance of the eROSITA survey. In addition to the larger number of systems, eROSITA will detect clusters to higher redshifts than before, reaching beyond $z = 1$, which requires a deeper optical survey than SDSS-IV. The survey will constrain the physics of the warm baryons, which in turn traces the evolution of the cosmic feedback. In addition to the properties of warm intergalactic gas in groups and clusters, X-ray emission traces the state of the warm gas in the filaments, which completes the picture of warm baryons in the Universe and complements similar studies using absorption techniques (Nicastro et al., 2018).

Specific scientific goals

The primary scientific goal of the survey is to provide a spectroscopic study of 40 000 groups and clusters of galaxies within the German eROSITA sky (for details of the eROSITA survey, see Merloni et al., 2012), reaching a redshift of 1.4 to maximise the expected cosmological performance of the survey (for details of the cosmological forecast, see Pillepich et al., 2018). The primary uses of the 4MOST spectroscopic observations performed for the eROSITA Galaxy Cluster Redshift Survey are:

1. To spectroscopically confirm the photometric counterpart of the X-ray emission by removing projection effects in photometric galaxy membership assignment for galaxy clusters (Clerc et al., 2016) and to provide the spectroscopic counterparts to the X-ray emission coming from the galaxy groups (halos with total mass below $10^{14} M_{\odot}$).
2. To obtain a precise distance estimate required to compute X-ray luminosity, which enters the mass function cosmological study as a mass proxy (Grandis et al., 2018).
3. To perform dynamical mass calibration (Capasso et al., 2019). The survey will provide dynamical mass as well as caustic mass measurements for 10 000 clusters of galaxies at redshifts $z < 0.6$ and total masses $> 10^{14} M_{\odot}$, which enables us to very accurately link the cluster observables to their total mass – critical for constraining the cosmology. A comparison of these measurements to the weak lensing mass estimates can further constrain the models of modified gravity (Wilcox et al., 2015).
4. To enable the analysis of clustering of groups and clusters, which have a different sensitivity in constraining cosmology through the large-scale structure growth estimates. Clustering analysis requires at least 1000 systems in order to detect significant signal. A sample of 40 000 groups and clusters allows us to sample the mass function with five mass bins and the redshift range with eight bins, which is required to break the degeneracy of the clustering amplitude between mass, redshift and cosmology (Pillepich et al., 2018).
5. To improve the link between the various baryonic phases of halos and improve the value of eROSITA cosmology by addressing the effects of baryons on the growth of structure (Bocquet et al., 2016).
6. To spectroscopically identify filaments to a redshift of 0.2, where a detection of the X-ray signal with eROSITA is expected. The study of the Warm Hot Intergalactic Medium (WHIM) in emission will be based on the combined 4MOST and eROSITA study, through

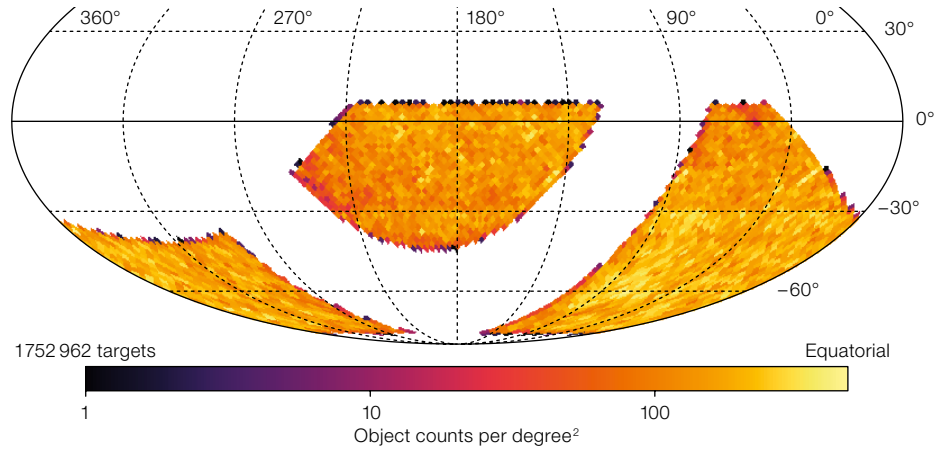

a cross-correlation analysis between the position of X-ray photons, detected by eROSITA and the 2D (sky) projections of the filaments.

7. The eROSITA Galaxy Cluster Redshift Survey will coordinate with the 4MOST WAVES Survey, where the eROSITA sample will provide high-signal-to-noise (S/N) observations of rare systems not sampled within the WAVES Survey area; 4MOST spectra with $S/N > 10$ per \AA are suitable for galaxy evolution science. Examples of these types of rare systems are galaxies in rare high-density environments in massive clusters and X-ray selected lowest mass galaxy groups that are selected in the Local Volume.

Science requirements

The science requirements for the 4MOST eROSITA Galaxy Cluster Redshift Survey consist of: achieving highly complete sampling of target galaxies required for the galaxy group and filament searches; covering a large area to maximise the number of spectroscopically confirmed groups and clusters of galaxies in order to improve the cosmological constraints; obtaining uniform coverage of sufficiently large areas to perform the clustering analysis to obtain additional cosmological constraints; delivering accurate calibration of cluster mass using dynamical and caustic mass measurement; and achieving high S/N for a subsample selected for galaxy evolution studies.

Figure 1. Target density of the 4MOST Cluster Survey, based on the mock catalogue tailored to the expectations of the eROSITA X-ray survey. About one third of the targets belong to the low-redshift ($z < 0.2$) survey.

Target selection and survey area

The target selection for the eROSITA cluster identification is carried out using the position of the extended X-ray source and running the red sequence cluster finder on deep photometry provided by the Dark Energy Survey (DES), the Dark Energy Camera Legacy Survey (DECaLS), Pan-STARRS1, VST ATLAS and ongoing imaging surveys with the Dark Energy Camera (DECam) and VST (DeROSITAs/KABS). Altogether, these will cover 10 000 square degrees accessible by 4MOST (see Figure 1).

In addition, the project to search for filaments has a strong synergy with the 4MOST Cosmology Redshift Survey in terms of targets. Therefore this part of the 4MOST Cluster survey will only be carried out over the survey area in common with the Bright Galaxy sub-survey of the 4MOST Cosmology Redshift Survey (7500 square degrees). In order to estimate the resulting target density, we have produced a mock target catalogue by combining the expected eROSITA performance at cluster detection with the mocks based on the MultiDark simulation (Comparat et al., 2017 & in preparation). The low-redshift ($z < 0.2$) part of the survey has about one million targets, which are bright ($K_s < 18$ magnitudes) and require short exposures (10 minutes). Multi-member cluster identification at high

redshift depends on the total exposure per field, with the trade-off being the highest redshift achievable within the total available time for the survey. The brightest cluster galaxies in each cluster are always considered for highest priority observations.

Spectral success criteria and figure of merit

The spectral success criteria are the measurements of galaxy redshifts. The figure of merit (FoM) for the entire survey encompasses multiple components, including:

- Obtaining redshifts for a million targets to sample galaxy cluster members, the brightest cluster member in each cluster being the highest priority. An

additional requirement is to determine redshifts for between 10 and 100 member galaxies within the virial radii for clusters with $z < 0.7$. This component requires 0.4 million fibre-hours in dark sky conditions to complete.

- A sufficiently large area to sample massive clusters, which are the most sensitive probes of the cosmology. The requirement (goal) is to survey 7500 (10 000) square degrees.
- Contiguous areas to enable the high-order statistical tests (two-point and three-point correlation functions). The requirement for the minimum size of each patch of contiguous area on the sky is 500 square degrees.
- A million bright targets to sufficiently sample low-redshift filaments and groups of galaxies. It requires 0.1 million fibre-hours in bright sky conditions to

complete. As with the 4MOST WAVES Survey, this places a strong requirement for the survey completeness.

The FoM of the survey is a function of the ratio of the covered to total area x :

$$\text{FoM} = 0.5 + 0.5 \operatorname{erf}((x - 0.75)/0.165)$$

FoM = 0.5 (0.9); for an area of 7500 (9000) square degrees made of contiguous 500 square-degree patches.

References:

- Albrecht, A. et al. 2006, arXiv:0609591
 Bocquet, S. et al. 2016, MNRAS, 456, 2361
 Capasso, R. et al. 2019, MNRAS, 482, 1043
 Clerc, N. et al. 2016, MNRAS, 463, 4490
 Comparat, J. et al. 2017, MNRAS, 469, 4157
 Grandis, S. et al. 2018, arXiv:1810.10553
 Merloni, A. et al. 2012, arXiv:1209.3114
 Nicastro, F. et al. 2018, Nature, 558, 406
 Pillepich, A. et al. 2018, MNRAS, 481, 613
 Wilcox, H. et al. 2015, MNRAS, 452, 1171



A VISTA image of the Fornax Galaxy Cluster, one of the closest clusters beyond the Local Group of galaxies.

4MOST Consortium Survey 6: Active Galactic Nuclei

Andrea Merloni¹
 David A. Alexander²
 Manda Banerji³
 Thomas Boller¹
 Johan Comparat¹
 Tom Dwelly¹
 Sotiria Fotopoulou²
 Richard McMahon³
 Kirpal Nandra¹
 Mara Salvato¹
 Scott Croom⁴
 Alexis Finoguenov^{1,5}
 Mirko Krumpe⁶
 Georg Lamer⁶
 David Rosario²
 Axel Schwobe⁶
 Tom Shanks²
 Matthias Steinmetz⁶
 Lutz Wisotzki⁶
 Gabor Worseck⁷

¹ Max-Planck-Institut für extraterrestrische Physik, Garching, Germany

² Department of Physics, Durham University, UK

³ Institute of Astronomy, University of Cambridge, UK

⁴ Sydney Institute for Astronomy, University of Sydney, Australia

⁵ University of Helsinki, Finland

⁶ Leibniz-Institut für Astrophysik Potsdam (AIP), Germany

⁷ Institut für Physik und Astronomie, Universität Potsdam, Germany

X-ray and mid-infrared emission are signposts of the accretion of matter onto the supermassive black holes that reside at the centres of most galaxies. As a major step towards understanding accreting supermassive black holes and their role in the evolution of galaxies, we will use the 4MOST multi-object spectrograph to provide a highly complete census of active galactic nuclei over a large fraction of the extragalactic sky observed in X-rays by eROSITA that is visible to 4MOST. We will systematically follow up all eROSITA point-like extragalactic X-ray sources (mostly active galactic nuclei), and complement them with a heavily obscured active galactic nuclei selection approach using mid-infrared data from the Wide-field Infrared Survey Explorer (WISE). The X-ray and mid-infrared flux limits of eROSITA and WISE are well matched to

the spectroscopic capabilities of a 4-metre-class telescope, allowing us to reach completeness levels of ~80–90% for all X-ray selected active galactic nuclei with fluxes $f_{0.5-2 \text{ keV}} > 10^{-14} \text{ erg s}^{-1} \text{ cm}^{-2}$; this is about a factor of 30 deeper than the ROSAT all-sky survey. With these data we will determine the physical properties (redshift, luminosity, line emission strength, masses, etc.) of up to one million supermassive black holes, constrain their cosmic evolution and clustering properties, and explore the connection between active galactic nuclei and large-scale structure over redshifts $0 \lesssim z \lesssim 6$.

Scientific context

The presence of a supermassive black hole (SMBH) at the centre of virtually every massive galaxy in the nearby Universe is a robust observational fact. However, their formation, growth, and connection to the evolution of galaxies and large-scale structure remain largely a mystery (for example, Alexander & Hickox, 2012). There is strong indirect evidence that the formation and growth of SMBHs and their host galaxies are closely related, but it is unclear what physical mechanisms are responsible for this close coupling. In order to discriminate between the varieties of different model predictions proposed in recent years, sizeable samples of active galactic nuclei (AGN) over different periods and phases in their evolution are needed. To this end, X-ray and mid-infrared (mid-IR) AGN searches are less biased by obscuration effects than optical ones and provide a solid foundation for the most comprehensive SMBH evolutionary studies. X-ray selected AGN are also more complete at the low end of the AGN luminosity function, where optical and mid-IR selection approaches are more affected by host galaxy light dilution.

Unfortunately, the current samples of X-ray and mid-IR selected AGN with spectroscopic redshifts are relatively small (a few thousand; see Figure 2) compared to the optically selected AGN samples available from large-area surveys like the Sloan Digital Sky Survey (SDSS). Consequently, the modest source statistics of X-ray and mid-IR selected AGN hamper our under-

standing of how the relationship between AGN and their host galaxies evolves as a function of redshift, AGN luminosity, nuclear obscuration, host galaxy mass, star formation properties, and large-scale environment. A complete AGN sample of hundreds of thousands of sources with spectroscopic redshifts and classifications is required to fully sample this multi-dimensional parameter space. The synergy between eROSITA (Merloni et al., 2012), complemented by VISTA near-IR and WISE mid-IR AGN selection, and 4MOST will allow this to become a reality.

The 4MOST AGN survey will provide spectroscopic identification for up to one million AGN out to redshifts of $z \sim 6$ over an area of about 10 000 square degrees (see Figure 1). The well understood X-ray and mid-IR AGN identification approaches, combined with the uniform and well characterised selection functions of the eROSITA and WISE all-sky surveys, will ensure a highly complete AGN selection, largely independent of the presence of nuclear obscuration. We will aim for a high level of spectroscopic completeness^a for the 4MOST AGN survey to keep statistical uncertainties to a minimal level. The WISE-selected AGN will include a sample of luminous dust-obscured quasars, which may be responsible for powerful AGN-driven feedback (for example, Banerji et al., 2012) and may escape detection by eROSITA given its predominantly soft X-ray response. Such a complete 4MOST AGN sample will serve as a benchmark against which to test competing models of SMBH formation and growth, and their connection to galaxies and large-scale structure in the Universe.

Specific scientific goals

Our science goals are set out below.

Evolution of the most massive and powerful SMBHs

The X-ray luminosity function (XLF) of moderate- and low-luminosity AGN ($L_X \lesssim 10^{44} \text{ erg s}^{-1}$) is relatively well constrained as a result of extensive studies following up on deep Chandra and XMM-Newton small- and medium-area surveys (see Figure 2 and, for example, Aird et al., 2015). In contrast, the eROSITA- (and WISE-) selected samples in the 4MOST AGN

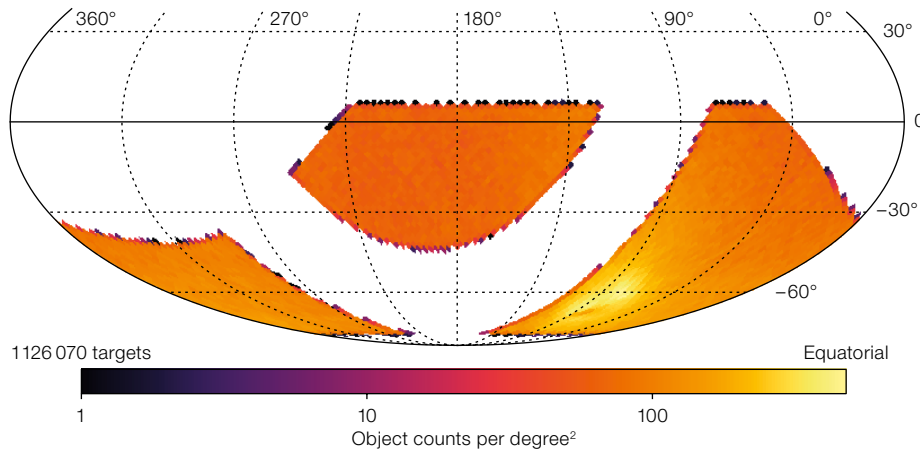

Figure 1. Sky density in equatorial coordinates of the 4MOST AGN targets, including all sub-survey components (based on the mock eROSITA catalogue of Comparat et al. [in preparation], and the current WISE-selected AGN catalogue).

survey will be geared towards the most luminous objects at any redshift, and are expected to provide an improvement of many orders of magnitude in the number of sources emitting above the break in the luminosity function (Figure 2). Redshift determination for these AGN will provide an unprecedented look at the evolution of the most massive and powerful SMBHs. Finally, in combination with optical and near-IR imaging surveys over the 4MOST survey footprints, we will also search for high-redshift quasar candidates at $z > 4$ to complement the tens of $z > 6$ X-ray selected AGN expected from eROSITA (see Figure 2).

Frequency of accreting SMBHs in the galaxy population

The highly complete X-ray and mid-IR sample of AGN will provide a legacy dataset from which to measure the incidence of accreting SMBHs within: (1) the $z < 1$ galaxy population; (2) merging galaxies and other morphological classes (delivered by high-quality optical/near-IR imaging from, for example, surveys from the Hyper Suprime-Cam [HSC], the Large Synoptic Survey Telescope [LSST], and the Euclid mission); (3) radio galaxies (and jet-dominated AGN of various classes, as delivered by future deep and wide-area radio surveys); and (4) large-scale structures such as voids, filaments, groups, clusters (from synergy with SZ surveys, CMB lensing, and X-ray cluster surveys, including eROSITA itself). Given the excellent source statistics, the 4MOST AGN survey will also allow for the most comprehensive measurements to date of the accretion rate distribution of

Figure 2. The central panel shows the predicted X-ray luminosity-redshift plane spanned by AGN selected by eROSITA within the 4MOST X-ray Wide and Deep areas (orange/red contours), compared to all known X-ray sources with spectroscopic redshifts detected in several deep and wide survey fields (COSMOS, Lockman Hole, CDFS and CDFN, XMM-XXL, black dots; SDSS/SPIDERS DR14, grey dots; Dwelly et al., 2017). The thick green line is the approximate location of the break in the AGN X-ray luminosity function L_x where the bulk of the accretion power is released. The thick cyan line is the approximate limit above which the IR Wide targets will be selected, assuming a standard infrared-to-X-ray conversion. The top histograms show the redshift distribution of eROSITA+4MOST sources (red/orange) compared to all other known X-ray sources (black, grey), while the right-hand histograms compare the respective luminosity distributions.

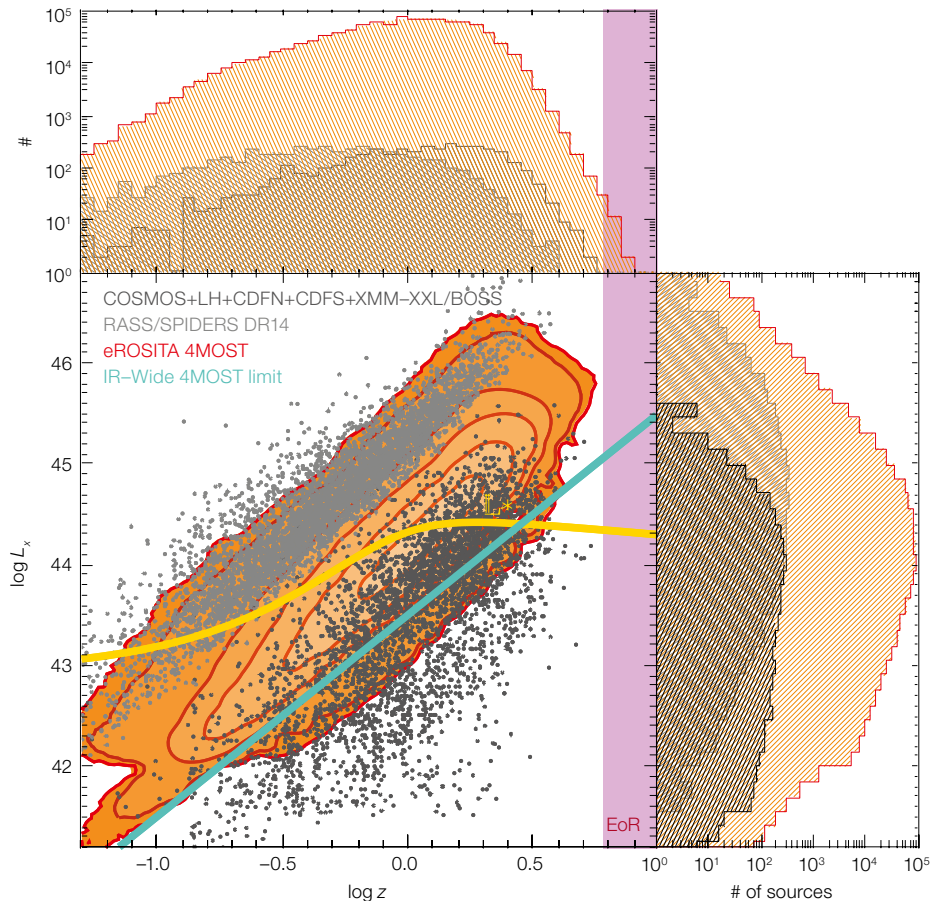

AGN as a function of redshift, luminosity, and host-galaxy properties.

SMBH and host-galaxy spectral measurements

The 4MOST optical spectra will allow for direct estimates of SMBH masses for the large subset of AGN with broad emission lines using virial relations (Shen, 2013). These measurements will probe the physics of accretion onto SMBHs, and will also allow for a direct investigation of the evolution of the SMBH-host galaxy scaling relations out to $z \sim 3$. For the population of lower-redshift AGN ($z < 1$) the well calibrated (see Science below) medium-resolution ($R \sim 6500$) spectra will also deliver quantitative measurements of a wide variety of AGN host-galaxy properties (stellar masses, star formation rates, dust reddening, stellar population ages, and metallicities; see, for example, Menzel et al., 2016) and the identification of AGN-driven outflows to constrain their impact on the star formation in the host galaxy (for example, Harrison, 2017). In addition, the LRS resolution will allow unambiguous identification of the [OII] doublet in the redshift range where it is the only feature in the spectrum with high signal to noise (S/N). This could be particularly important for the faint, obscured WISE AGN targets.

AGN activity and the large-scale environment

The measurement of the spatial clustering of AGN has emerged as a major way to investigate the relationship between AGN, their host galaxies and the larger-scale environment. AGN clustering measurements have the potential to: (1) determine the distribution of AGN as a function of dark matter halo mass (Krumpe et al., 2015); (2) infer AGN triggering mechanisms and lifetimes; and (3) measure the cosmological parameters (for example, via baryon acoustic oscillation [BAO] measurements; Kolodzig et al., 2013; Comparat et al., 2019). Direct measurements of the 3D spatial clustering in X-ray selected AGN samples at $z > 1$ have mostly been limited to medium-deep area surveys of only a few square degrees. These studies suggest that $z \sim 1$ X-ray selected AGN are more clustered than optically selected AGN. However, the results remain uncertain owing to the effects of cosmic variance, small number

statistics, and differences in luminosities. The large area and the sample size of eROSITA and WISE will significantly improve these studies, boosting our knowledge of the AGN clustering properties.

Fundamental cosmological constraints

In recent years it has been demonstrated beyond doubt that the X-ray:ultraviolet luminosity ratios of unobscured quasars follow a tight non-linear relationship. This allows them to be used as “standard candles” to probe the geometry of the expanding universe out to $z \sim 6$, in much the same way that type Ia Supernovae have been used at $z < 1$ (Risaliti & Lusso, 2018). The large AGN sample from eROSITA will provide excellent source statistics to improve the current cosmological constraints, particularly thanks to a few $10^4 z > 3$ quasars, which offer unique probes of the expansion history of the universe at high redshift.

Constraining AGN accretion physics via variability study

The survey area close to the South Ecliptic Pole (Deep survey, see below) will be revisited at X-ray wavelengths several times thanks to the eROSITA scanning strategy (Merloni et al., 2012), and will also be covered by a denser tiling of 4MOST pointings, because of the high source density in this region (which includes the LMC targets). This will allow for additional unique scientific opportunities for the study of time-variable AGN, including eclipsing sources, variable absorption and dramatic flux variability events (“changing look” AGN).

Science requirements

The aforementioned scientific goals require a highly complete and uniform set of spectroscopic redshift measurements over a very large area. The uniformity of the selection, necessary to achieve most of the science goals, will be guaranteed by the well-understood and uniform eROSITA and WISE selection functions, provided that nearly complete counterpart identification and successful spectroscopic redshift measurements are achieved. These simple goals drive most of the science requirements, which we list here.

- To cover an overall area of $\sim 10\,000$ square degrees.
- To target both the point-like and the extended optical source counterparts of eROSITA- and WISE-selected AGN with an average sky density of ~ 100 – 120 per square degree.
- To observe the area around the South Ecliptic pole (~ 300 square degrees) more frequently (with a cadence of at least half a year) and deeper with a target density of ~ 200 per square degree.
- To robustly measure redshifts for faint targets (down to $r = 22.5$ – 23.0 magnitudes) and to derive physical characteristics of the brighter sources from high S/N optical spectra.
- To achieve good (better than 10% accuracy) relative flux calibration so as to use AGN and host galaxy continuum measurements to derive physical characteristics from continuum and emission-line flux measurements.

Target selection and survey area

The goal for the 4MOST AGN survey is to obtain spectra for ~ 80 – 90% of the X-ray and mid-IR selected AGN samples to yield redshifts for up to one million AGN. The survey area is defined by the eROSITA all-sky X-ray survey whose proprietary data rights lie with the MPE-led German Consortium. eROSITA will observe most of the area to a relatively uniform depth with two deeper regions around the ecliptic poles. We have therefore defined two separate sub-components to the survey: the X-ray Wide Survey, covering almost all of the German eROSITA extragalactic sky visible with 4MOST ($10\,000$ square degrees); and the X-ray Deep Survey, covering a circle of ~ 300 square degrees centred on the South Ecliptic Pole. To these will be added a third component, the IR WIDE Survey, which shares the footprints with the X-ray Wide area, and selects targets based on their WISE mid-IR properties.

The target selection of the eROSITA sources is straightforward — all eROSITA X-ray detected point sources within the 4MOST extragalactic footprints will be targeted with the Low-Resolution Spectrograph (LRS) fibres. The eROSITA PSF (~ 28 -arcsecond half energy width) is

| Name | Area (deg ²) | Average density (deg ⁻²) | Limiting magnitude | Number of sources (10 ³) | Selection notes |
|----------------|--------------------------|--------------------------------------|--|--------------------------------------|--|
| X-ray Wide | 10 000 | ~90 | $r < 22.8$ | ~800 | $F_{0.5-2 \text{ keV}} > 10^{-14} \text{ erg s}^{-1} \text{ cm}^{-2}$ |
| IR Wide | 10 000 | ~20 | $r < 22.8$ | ~180 | See Mateos et al., 2012 |
| X-ray Deep | 300 | ~200 | $r < 23.2$ | ~50 | $F_{0.5-2 \text{ keV}} > 5 \times 10^{-15} \text{ erg s}^{-1} \text{ cm}^{-2}$ |
| High-z Quasars | 10 000 | ~4 | $i_{\text{AB}} < 22.5 (z > 5)$ $z_{\text{AB}} < 22.0 (z > 6)$ | ~40 | See Reed et al., 2017 |

sufficient to distinguish X-ray AGN (and stars) from the most common extended X-ray sources (clusters of galaxies; Clerc et al., 2018). In the X-ray Wide Survey, we expect ~90% of the eROSITA sources with $f_{0.5-2 \text{ keV}} > 10^{-14} \text{ erg s}^{-1} \text{ cm}^{-2}$ to be brighter than $r = 22.8$ magnitudes; in the X-ray Deep Survey we expect ~90% of the sources with $f_{0.5-2 \text{ keV}} > 5 \times 10^{-15} \text{ erg s}^{-1} \text{ cm}^{-2}$ to be brighter than $r = 23.4$ magnitudes, and this sets our expected survey depth. These X-ray selected AGN will be complemented with near- and mid-IR AGN selected from the VISTA Ks and WISE W1-W3 bands using colour selection techniques (for example, Mateos et al., 2012), potentially supplemented with a machine-learning approach to improve the AGN-selection efficiency and completeness (for example, Fotopoulou & Paltani, 2018). The eROSITA X-ray sources will provide the majority of the AGN sample, but the WISE mid-IR AGN will be important to select the heavily obscured AGN, which will be missed because of the relatively soft X-ray response of eROSITA, to give a highly complete 4MOST AGN sample.

Finally we will also carry out a High-z Quasar Survey using a combination of optical, near-IR and mid-IR data (for example, from DES, HSC, LSST, VISTA and WISE) to $i < 22.5$ magnitudes for $5 < z < 6$ selection, $z < 22.0$ magnitudes for $6 < z < 6.5$, and spectral energy distribution based techniques to select and classify the targets (for example, Reed et al., 2017).

Spectral success criteria and figure of merit

The spectral success criteria are defined using an empirical relation between the redshift measurement success and S/N over different broad bands from the Baryon Oscillation Spectroscopic Survey (BOSS) of X-ray selected AGN (Menzel et

al., 2016). The BOSS campaign targeted XMM-Newton AGN with counterparts brighter than $r = 22.5$ magnitudes to be representative of the 4MOST targets. Taking a < 3% failure rate as a target threshold, and scaling for the different resolutions of the BOSS and 4MOST LRS, we obtain the following S/N estimates per pixel thresholds: 2.1, 2.4 and 2.8 for the three arms of the 4MOST spectrograph (i.e., blue, green and red). It is expected that the above criteria are very conservative, as they are based on continuum measurements for a set of objects which should contain numerous narrow emission/absorption lines, which will be used to successfully measure redshifts. We envisage that all counterparts of eROSITA-detected point-like X-ray sources will be observed by 4MOST with up to a maximum of ~2 hours exposure. The spectral success criteria for the WISE-selected AGN will be comparable to the eROSITA-selected AGN, given the similar distribution of optical magnitudes and redshifts (for example, Lam, Wright, & Malkan, 2018).

The overall survey figure of merit definition is driven by the main requirement to reach the highest possible level of spectroscopic completeness (minimum requirement of 90% for the wide surveys, and 80% for the deep one) over an area of 10 000 square degrees (Wide) and 300 square degrees (Deep).

References

- Aird, J. et al. 2015, MNRAS, 451, 1892
Alexander, D. M. & Hickox, R. C. 2012, NewAR, 56, 93
Banerji, M. et al. 2012, MNRAS, 427, 2275
Clerc, N. et al. 2018, A&A, 617, 92
Comparat, J. et al., MNRAS, submitted
Dwelly, T. et al. 2017, MNRAS, 469, 1065
Fotopoulou, S. & Paltani, S. 2018, A&A, 619, 14
Harrison, C. M. 2017, Nature Astron., 1, 0165
Kolodzig, A. et al. 2013, A&A, 558, A90
Krumpe, M. et al. 2015, ApJ, 815, 21
Lam, A., Wright, E. & Malkan, M. 2018, MNRAS, 480, 451
Mateos, S. et al. 2012, MNRAS, 426, 3271

Table 1. Summary of 4MOST AGN survey characteristics: (1) area covered, requirements; (2) average target density; for the IR Wide survey, we quote the total number of unique targets, after accounting for duplicates with the X-ray Wide survey; (3) approximate limiting optical magnitudes; (4) total number of spectra to be obtained in order to satisfy the spectral success criteria.

- Menzel, M.-L. et al. 2016, MNRAS, 457, 110
Merloni, A. et al. 2012, arXiv:1209.3114
Reed, S. L. et al. 2017, MNRAS, 468, 4702
Risaliti, G. & Lusso, E. 2019, Nature Astronomy, in press
Shen, Y. 2013, Bulletin of the Astronomical Society of India, 41, 61

Notes

- ^a Here we define completeness as the fraction of X-ray and mid-IR sources in the targeting samples for which we successfully acquire spectroscopic redshift measurements.

4MOST Consortium Survey 7: Wide-Area VISTA Extragalactic Survey (WAVES)

Simon P. Driver¹
 Jochen Liske²
 Luke J. M. Davies¹
 Aaron S. G. Robotham¹
 Ivan K. Baldry³
 Michael J. I. Brown⁴
 Michelle Cluver⁵
 Koen Kuijken⁶
 Jon Loveday⁷
 Richard McMahon⁸
 Martin J. Meyer¹
 Peder Norberg⁹
 Matt Owers¹⁰
 Chris Power¹
 Edward N. Taylor⁵
 and the WAVES team

¹ International Centre for Radio Astronomy Research/University of Western Australia, Perth, Australia

² Hamburger Sternwarte, Universität Hamburg, Germany

³ Astrophysics Research Institute, Liverpool John Moores University, UK

⁴ School of Physics and Astronomy, Monash University, Melbourne, Australia

⁵ Centre for Astrophysics and Supercomputing, Swinburne University of Technology, Hawthorn, Australia

⁶ Sterrewacht Leiden, Universiteit Leiden, the Netherlands

⁷ University of Sussex, Brighton, UK

⁸ Institute of Astronomy, University of Cambridge, UK

⁹ Department of Physics, Durham University, UK

¹⁰ Department of Physics and Astronomy, Macquarie University, Sydney, Australia

WAVES is designed to study the growth of structure, mass and energy on scales of ~ 1 kpc to ~ 10 Mpc over a 7 Gyr timeline. On the largest length scales (1–10 Mpc) WAVES will measure the structures defined by groups, filaments and voids, and their emergence over recent times. Comparisons with bespoke numerical simulations will be used to confirm, refine or refute the Cold Dark Matter paradigm. At intermediate length scales (10 kpc–1 Mpc) WAVES will probe the size and mass distribution of galaxy groups, as well as the galaxy merger rates, in order to directly measure the assembly of dark matter halos and stellar mass. On the

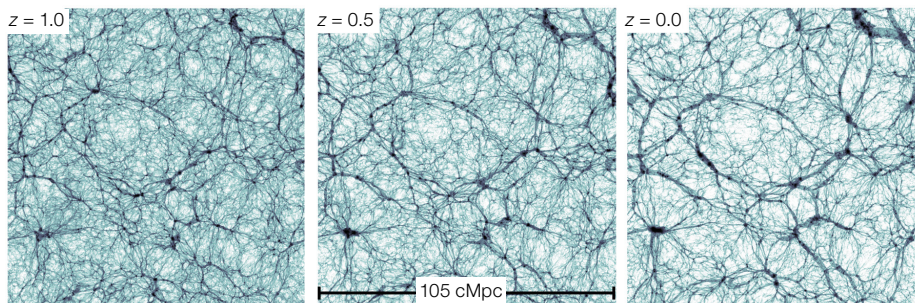

smallest length scales (1–10 kpc) WAVES will provide accurate distance and environmental measurements to complement high-resolution space-based imaging to study the mass and size evolution of galaxy bulges, discs and bars. In total, WAVES will provide a panchromatic legacy dataset of ~ 1.6 million galaxies, firmly linking the very low ($z < 0.1$) and intermediate ($z \sim 0.8$) redshift Universe.

Scientific context

The structures which we see in the Universe today, from galaxies to groups, clusters, filaments and voids, were moulded by the underlying dark matter distribution and its hierarchical assembly (Fall & Efstathiou, 1980; Frenk et al., 1988) — without dark matter, large scale structure, galaxies, stars and indeed life would not exist. Numerical simulations of the growth of dark matter structures (for example, Springel et al., 2005) start with initial conditions provided by observations of the cosmic microwave background and then apply only the action of gravity. These simulations successfully explain the very large-scale structure seen in the Universe today, as revealed on Mpc scales and above by surveys such as the Two-degree Field Galaxy Redshift Survey (2dFGRS; Colless et al., 2001), the Sloan Digital Sky Survey (SDSS; York et al., 2000), and the Galaxy And Mass Assembly (GAMA) survey (Driver et al., 2011; Liske et al., 2015).

The latest dark matter simulations (for example, Ishiyama et al., 2015; Ludlow et al., 2016) predict fine details in this structure down to relatively low masses ($10^9 M_\odot$), as well as strong evolution in the growth of large-scale structure on scales of 1 to 100 Mpc over relatively recent

Figure 1. Three panels showing a 105×105 co-moving Mpc simulated box of the underlying dark matter distribution at three redshifts (z). The predicted evolution of the density field results in the movement of mass from voids into filaments, groups and clusters. Measuring this evolution by constructing group, filament and void catalogues is one of the core science goals of WAVES. The figure is by P. Elahi, based on the Synthetic Universe For Surveys (SURFS) simulations (Elahi et al., 2018).

times (see Figure 1). This mass flow, from lower to higher density environments, results in the late-time emergence of massive groups and clusters, which can be used to directly trace the evolution in the underlying dark matter distribution (Robotham et al., 2011; Alpaslan et al., 2014).

With most major spectroscopic galaxy surveys (for example, the Dark Energy Spectroscopic Instrument [DESI] survey; DESI Collaboration, 2016) focusing on the sparse sampling of large areas, WAVES¹ is unique in pursuing a fully sampled, high-completeness strategy over relatively modest volumes. This high-density sampling will allow us to directly observe the emergence of fine structure (i.e., groups, filaments and voids), trace the growth of mass and its environmental dependence (i.e., mergers and *in-situ* star formation; Davies et al., 2015), and follow the primary energy production pathways (i.e., star formation and active galactic nuclei) on kpc to 100 Mpc scales — length scales over which the interaction of dark matter with baryons is strongest.

WAVES will test the Cold Dark Matter (CDM) paradigm by measuring redshifts for ~ 1.6 million galaxies, split between two sub-surveys. WAVES-Wide will cover an area of ~ 1200 square degrees, probing to significantly lower galaxy and halo masses in the low-redshift Universe than previous surveys. WAVES-Deep will cover

an area of ~ 70 square degrees to quantify the evolution of structure, mass and energy production over a ~ 7 Gyr baseline. Within the environments probed by WAVES, we will extend studies of the galaxy population and its evolution to lower stellar masses and to more diffuse and lower-surface-brightness systems than was previously possible, while tracing a timespan over which half of the stars in the Universe formed and within which the Hubble sequence emerged. Our goal is to understand the physical processes that drive the evolution of gas to stars and the dependence of these processes on the host galaxy, halo properties and the larger-scale environment.

Specific scientific goals

Below we briefly list some of the core science goals we plan to pursue with WAVES-Wide and WAVES-Deep. In the following, Z refers to the apparent AB magnitude in the Z -band, and z_{phot} to the photometric redshift as estimated from broad-band *ugriZYJKs* photometry.

WAVES-Wide (~ 0.9 million galaxies with $Z \leq 21.1$ magnitudes and $z_{\text{phot}} \leq 0.2$):

- Identify 50 000 dark matter halos down to a halo mass of $\sim 10^{11} M_{\odot}$ and measure the Halo Mass Function as well as the halo mass–baryonic content relation over 4 orders of magnitude in mass.
- Measure the void distribution function within a representative volume of the Universe (i.e., with sample variance $< 5\%$).
- Measure the length, width and mass content of filaments and tendrils within a representative volume of the Universe (i.e., with sample variance $< 5\%$).
- Quantify the star formation rates, masses and structural properties of central and satellite systems, across a wide range of dark matter halo mass.

- Identify 10 000 Milky-Way-mass ($10^{12} M_{\odot}$) halos to study galaxy properties in the most typical environment in which most mass resides.

WAVES-Deep (~ 0.75 million galaxies with $Z \leq 21.25$ magnitudes and $z_{\text{phot}} \leq 0.8$):

- Identify 20 000 dark matter halos down to a halo mass of $\sim 10^{14} M_{\odot}$ over a broad redshift range and measure the predicted evolution of the high-mass end of the Halo Mass Function.
- Measure the major and minor galaxy merger rates across a broad range of environments and dark matter halo mass to $z \sim 0.8$.
- Quantify the gas, stellar and dust mass growth of galaxies and of their structural components as a function of environment to $z \sim 0.8$.
- Measure the evolution of the cosmic spectral energy distribution, and thus the evolution of energy production in the Universe, to $z \sim 0.8$ by combining WAVES-Deep with complementary X-ray, ultraviolet, optical, infrared and radio imaging data.

Science requirements

Completeness: For both WAVES-Wide and WAVES-Deep we require spectroscopic completeness of $> 90\%$ to be able to robustly identify galaxy groups.

Area: We require mostly contiguous survey areas of sufficient extent to ensure that sample variance is smaller than 5% at all redshifts (Driver & Robotham, 2010):

- At $z \leq 0.2$ we require an area > 1200 square degrees ($\sim 0.075 \text{ Gpc}^3$).
- At $z \sim 0.50$ we require an area > 50 square degrees ($\sim 0.04 \text{ Gpc}^3$ for $\Delta z = 0.05$).
- At $z \sim 0.80$ we require four areas, each with > 4 square degrees ($\sim 0.015 \text{ Gpc}^3$ for $\Delta z = 0.05$).

Depth: For WAVES-Deep we aim to probe below the “knee” of the stellar mass function, to ensure we capture the majority of stellar mass at all epochs, out to a redshift of ~ 0.8 . This requires a limiting magnitude of $Z \sim 21.25$ magnitudes. For WAVES-WIDE we will go as deep as time allows over the required area (~ 1200 square degrees), resulting in a limit of $Z \sim 21.1$ magnitudes. This provides a 1.3-magnitude improvement over the previous GAMA survey (236 square degrees) and the planned DESI Bright Galaxy Survey (14 000 square degrees).

Field locations: WAVES-Wide is confined to the footprint of the Kilo-Degree Survey (KiDS) and the VISTA Kilo-Degree Infrared Galaxy Survey (VIKING), as these surveys provide the data necessary to construct the WAVES-Wide input catalogue. These data are of sufficient depth, resolution and quality to enable robust flux measurements matched to the 4MOST spectroscopic limit, to achieve robust star-galaxy separation, and to provide reliable photometric redshifts to a precision of ± 0.03 (Bilicki et al., 2018), required to select targets with $z_{\text{phot}} \leq 0.2$.

WAVES-Deep comprises the G23 region of the GAMA survey, because of its extensive multi-wavelength coverage, as well as the central 4 square degrees of each of the four declared Deep Drilling Fields of the Large Synoptic Survey Telescope (LSST). These will be key focus areas for future observations with ground-based radio interferometers and space-based imaging facilities, including the ESA Euclid mission (cf. Figure 2). The exact locations of these deep fields are, however, subject to change.

| Survey region | Right ascension (α) (deg) | Declination (δ) (deg) | Area (deg ²) | Target selection | Target density (deg ⁻²) | No. of targets (10 ³) |
|------------------------------|---------------------------------------|-----------------------------------|-----------------------------|----------------------------|--|--------------------------------------|
| WAVES Wide North (WWN) | $157 < \alpha < 225$ | $-3 < \delta < 4$ | 545 | $Z < 21.1$ | 750 | 410 |
| WAVES Wide South (WWS) | $-30 < \alpha < 52.5$ | $-35.9 < \delta < -27$ | 625 | $z_{\text{phot}} \leq 0.2$ | 750 | 470 |
| WAVES Deep (WD23) [GAMA23] | $-21 < \alpha < -9$ | $-35 < \delta < -30$ | 50 | $Z < 21.25$ | 11 000 | 550 |
| WAVES Deep (WD01) [ELAIS-S] | 8.95 | -43.70 | 4 | $z_{\text{phot}} \leq 0.8$ | 11 000 | 45 |
| WAVES Deep (WD02) [XMMLSS] | 35.5 | -5.55 | 4 | | 11 000 | 45 |
| WAVES Deep (WD03) [ECDFS] | 53.0 | -28.0 | 4 | | 11 000 | 45 |
| WAVES Deep (WD10) [E-COSMOS] | 150.12 | 2.50 | 4 | | 11 000 | 45 |
| Total | | | 1236 | | | 1610 |

Table 1. WAVES field locations and areas, selection criteria and input catalogue size.

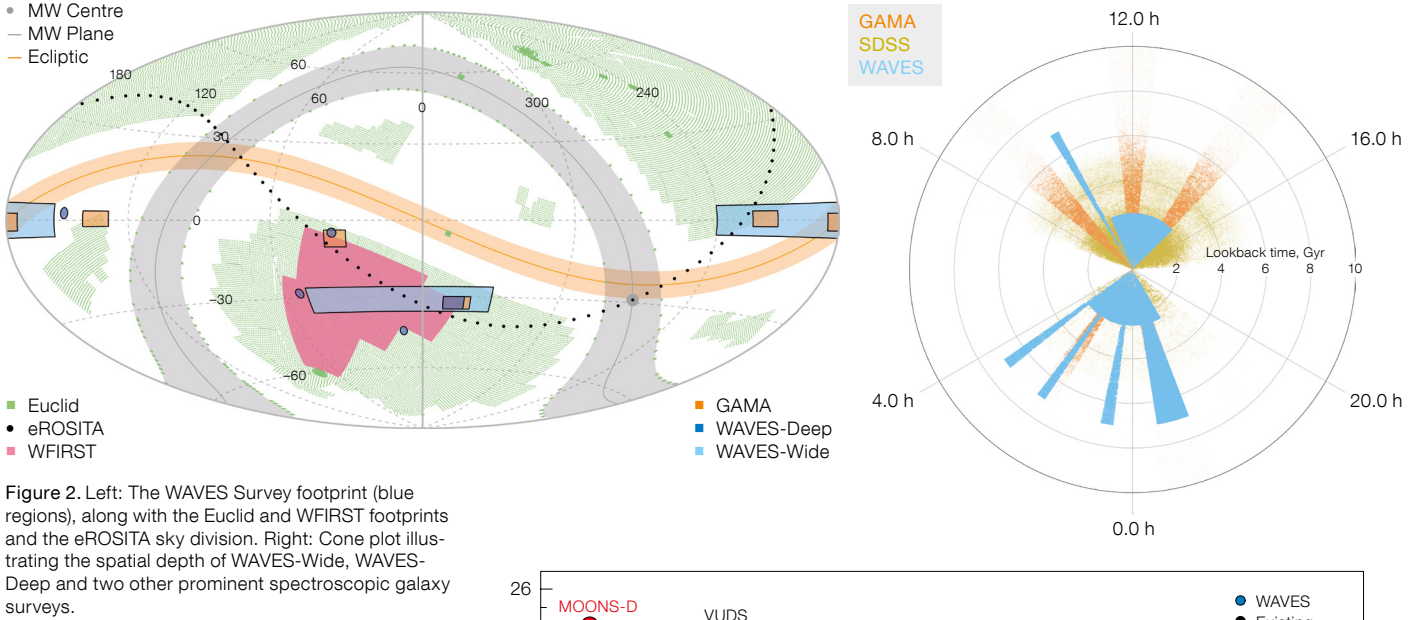

Figure 2. Left: The WAVES Survey footprint (blue regions), along with the Euclid and WFIRST footprints and the eROSITA sky division. Right: Cone plot illustrating the spatial depth of WAVES-Wide, WAVES-Deep and two other prominent spectroscopic galaxy surveys.

Target selection and survey area

Table 1 specifies our current survey design, indicating the survey regions and the selection criteria we are likely to apply to our input catalogue in terms of the limiting Z -band flux (Z), and a photometric redshift estimate (z_{phot}) based on our $ugriZYJKs$ data from KiDS and VIKING. An additional criterion is star-galaxy separation, which will likely be based on the $J-K_s$ colour and the measured half-light radius. Objects classified as stars by their colour or size will not be targeted.

The above survey design was derived from a combination of factors which include: detailed simulations of the growth of structure; the need to reduce sample variance to below 5% (Driver & Robotham, 2010); observability with 4MOST; the availability of appropriate data for an input catalogue; and declared future multi-wavelength survey programmes likely to complement and maximise the survey’s legacy value (for example, those currently expected from the LSST, the Square Kilometre Array [SKA], Euclid, and the Wide Field Infrared Survey Telescope [WFIRST]).

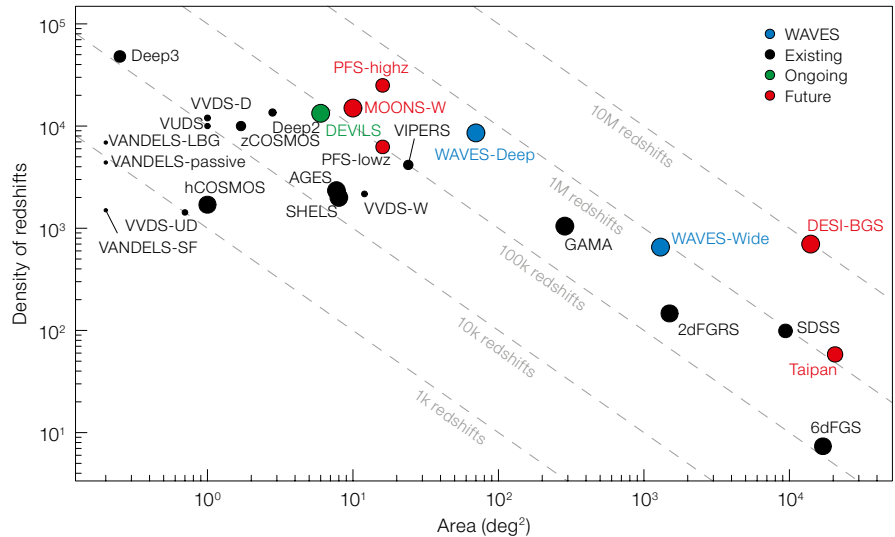
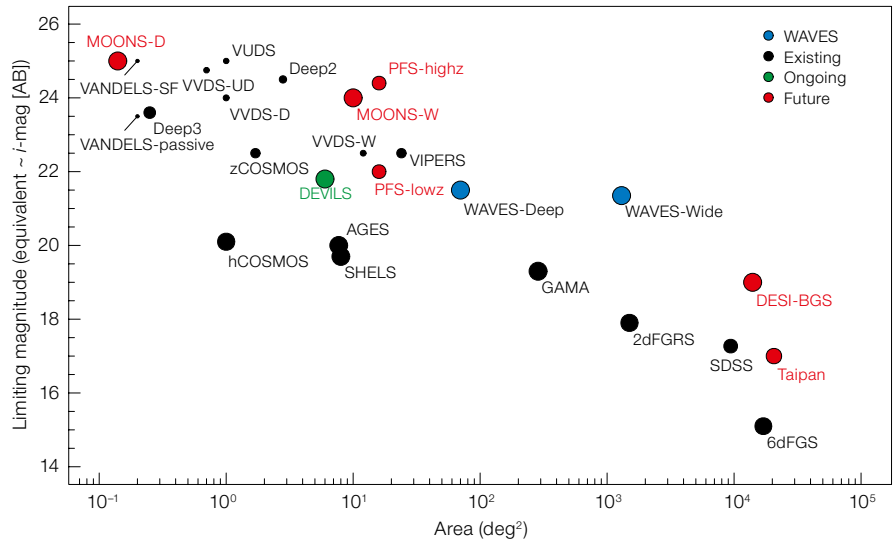

Figure 3. A comparison of recent, ongoing and future surveys showing the competitive edge of WAVES in the parameter space of area, limiting magnitude and target density.

The left panel of Figure 2 shows the WAVES footprint on the sky and its overlap with the forthcoming Euclid and WFIRST space-based imaging programmes. The right panel indicates the improvement of WAVES over the SDSS and GAMA surveys as it pushes to both higher density nearby and to higher lookback times (indicated by the radial axis). Figure 3 shows the competitiveness of WAVES compared to recent, ongoing and future spectroscopic programmes in terms of area, limiting magnitude and target density.

Spectral success criteria and figure of merit

A WAVES target will be deemed successfully observed if its redshift can be measured with a confidence greater than 90% from its 4MOST spectrum. The ability to construct a high-quality group catalogue,

and hence the value of WAVES, depends sensitively on its spectroscopic completeness. We have thus chosen to define the WAVES figure of merit (FoM) purely in terms of completeness and to do so highly non-linearly; the FoM is a power-law function of the completeness, with an exponent of 3 up to a completeness of 0.9, and an exponent of 6 thereafter. The normalisation is chosen such that our requirement of a completeness of 0.9 results in a FoM = 0.5, whereas our goal of a completeness of 0.95 gives a FoM = 1.0.

The above FoM is first defined independently for WAVES-Wide and WAVES-Deep. The overall WAVES FoM is then defined as the lower of the two sub-survey FoMs.

Acknowledgements

We acknowledge funding from our universities, the Australian Research Council (ARC), the Australian

Department of Industry, Innovation and Science (DIIS) and the Deutsche Forschungsgemeinschaft (DFG).

References

Alpaslan, M. et al. 2014, MNRAS, 438, 177
 Bilicki, M. et al. 2018, A&A, 616, A69
 Colless, M. et al. 2001, MNRAS, 328, 1039
 Davies, L. J. M. et al. 2015, MNRAS, 452, 616
 DESI Collaboration: Aghamousa, A. et al. 2016, arXiv:1611.00036
 Driver, S. P. & Robotham, A. S. G. 2010, MNRAS, 407, 2131
 Driver, S. P. et al. 2011, MNRAS, 413, 971
 Elahi, P. et al. 2018, MNRAS, 475, 5338
 Fall, S. M. & Efstathiou, G. 1980, MNRAS, 193, 189
 Frenk, C. S. et al. 1988, ApJ, 327, 507
 Ishiyama, T. et al. 2015, PASJ, 67, 61
 Liske, J. et al. 2015, MNRAS, 452, 2087
 Ludlow, A. et al. 2016, MNRAS, 460, 1214
 Robotham, A. S. G. et al. 2011, MNRAS, 416, 2640
 Springel, V. et al. 2005, Nature, 435, 629
 York, D. G. et al. 2000, AJ, 120, 1579

Links

¹ The WAVES survey: <https://wavesurvey.org/>

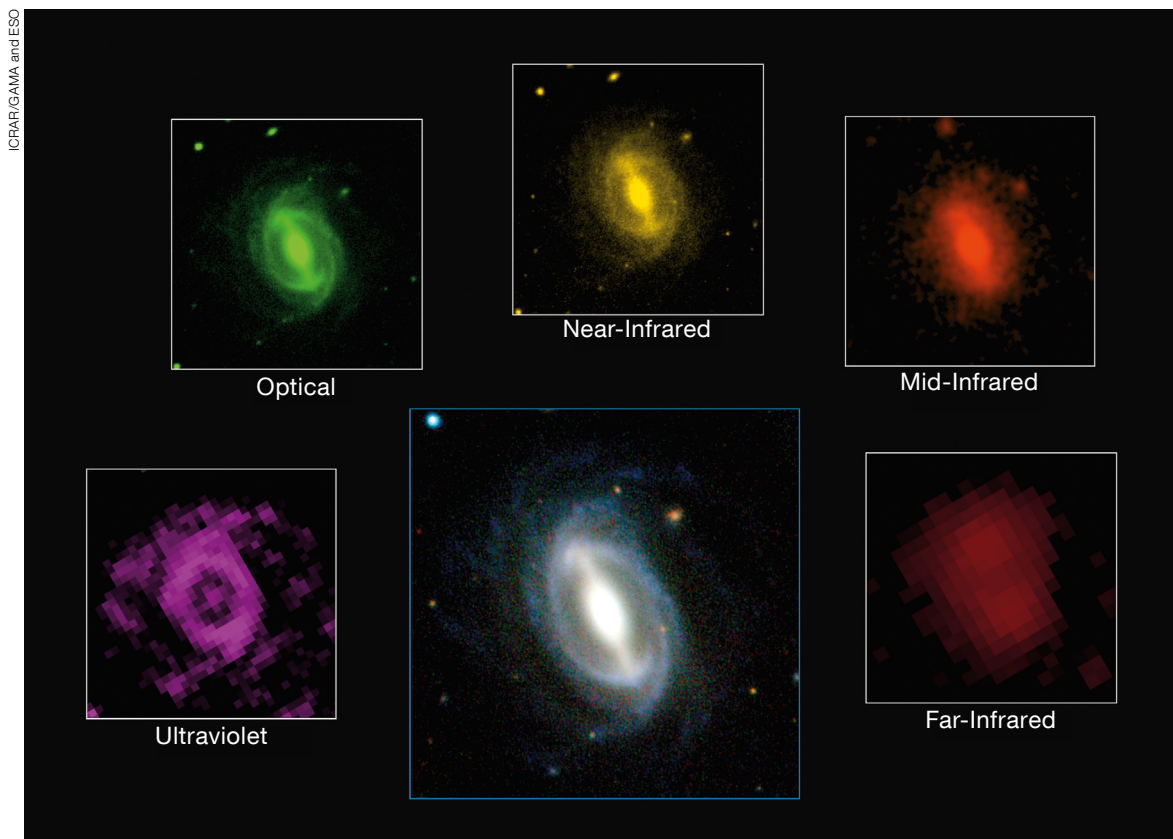

A typical galaxy from the GAMA survey observed at different wavelength regimes.

4MOST Consortium Survey 8: Cosmology Redshift Survey (CRS)

Johan Richard¹
 Jean-Paul Kneib²
 Chris Blake³
 Anand Raichoor²
 Johan Comparat⁴
 Tom Shanks⁵
 Jenny Sorce^{1,6}
 Martin Sahlén⁷
 Cullan Howlett⁸
 Elmo Tempel^{9,6}
 Richard McMahon¹⁰
 Maciej Bilicki¹¹
 Boudewijn Roukema^{12,1}
 Jon Loveday¹³
 Dan Pryer¹³
 Thomas Buchert¹
 Cheng Zhao²
 and the CRS team

¹ Centre de Recherche Astrophysique de Lyon, France

² Laboratoire d'astrophysique, École Polytechnique Fédérale de Lausanne, Switzerland

³ Centre for Astrophysics and Supercomputing, Swinburne University of Technology, Hawthorn, Australia

⁴ Max-Planck-Institut für extraterrestrische Physik, Garching, Germany

⁵ Department of Physics, Durham University, UK

⁶ Leibniz-Institut für Astrophysik Potsdam (AIP), Germany

⁷ Department of Physics and Astronomy, Uppsala universitet, Sweden

⁸ International Centre for Radio Astronomy Research/University of Western Australia, Perth, Australia

⁹ Tartu Observatory, University of Tartu, Estonia

¹⁰ Institute of Astronomy, University of Cambridge, UK

¹¹ Sterrewacht Leiden, Universiteit Leiden, the Netherlands

¹² Torun Centre for Astronomy (TCfA), Nicolaus Copernicus University, Poland

¹³ University of Sussex, Brighton, UK

The 4MOST Cosmology Redshift Survey (CRS) will perform stringent cosmological tests via spectroscopic clustering measurements that will complement the best lensing, cosmic microwave background and other surveys in the southern hemisphere. The combination of carefully selected samples of bright galaxies, luminous red galaxies, emis-

sion-line galaxies and quasars, totalling about 8 million objects over the redshift range $z = 0.15$ to 3.5 , will allow definitive tests of gravitational physics. Many key science questions will be addressed by combining CRS spectra of these targets with data from current or future facilities such as the Large Synoptic Survey Telescope, the Square Kilometre Array and the Euclid mission.

Scientific context

A wide variety of cosmological observations suggest that, in the standard interpretation, the Universe has entered a phase of accelerating expansion propelled by some form of dark energy. The physical nature of dark energy is not yet understood, and may reflect the general-relativistic nature of structure formation, new contributions in the matter-energy sector, or new fundamental theory, such as modifications to gravitational physics on cosmic scales. Past studies of the effects of dark energy have particularly focused on mapping the expansion history of the Universe, for example, using baryon acoustic oscillations (BAO) as a standard ruler or Type Ia Supernovae as standard candles. These probes have yielded important constraints on the homogeneous expanding Universe, including $\sim 1\%$ distance measurements and a $\sim 5\%$ determination of the equation of state of dark energy. Future surveys, for example by the Dark Energy Spectroscopic Instrument (DESI)¹ or Euclid² will improve these distance constraints to sub-percent measurements in narrow redshift bins.

However, in order to distinguish between the different possible manifestations of dark energy, these measurements of expansion must be supplemented by accurate observations of the gravitational growth of the inhomogeneous clumpy Universe. There are several important signatures of gravitational physics which may be used for this purpose, including the peculiar motions of galaxies or clusters and the patterns of weak lensing imprinted by the deflections of light rays from either distant galaxies or the cosmic microwave background (CMB). These probes rely, to a significant degree, on the cross correlation of imaging datasets

with spectroscopic redshift information in order to construct the most precise available observational tests of gravity, and mitigate the most significant systematic effects that limit the efficacy of these tests, such as the calibration of photometric redshifts and galaxy bias. Spectroscopy of the southern hemisphere is vital to enable these advances; there is currently no existing large-scale southern hemisphere redshift survey beyond the local Universe. DESI will survey the northern sky, and the future Taipan Galaxy Survey³ and Euclid satellite will map structure in the redshift ranges $z < 0.2$ and $1 < z < 2$, respectively, missing out the $0.2 < z < 1$ interval which is key for tracing the physical effects of dark energy. Moreover, current deep imaging from the Dark Energy Survey (DES)⁴ and Kilo-Degree Survey (KiDS)⁵, future imaging by the Large Synoptic Survey Telescope (LSST)⁶, CMB Stage 4 experiments, and future radio surveys by the Square Kilometre Array (SKA) and its precursors, MeerKAT and the Australian Square Kilometre Array Pathfinder (ASKAP), will all concern the southern hemisphere. Southern-hemisphere spectroscopic follow-up with 4MOST is critical for successfully completing the multiple science cases for these facilities.

The 4MOST CRS will make a fundamental contribution to tests of gravitational physics by constructing a unique redshift-space map of the large-scale structure for ~ 8 million galaxies and quasars in the southern hemisphere out to redshift $z = 3.5$. This map will be cross-correlated with complementary current and future datasets to carry out key cosmological tests. The area of overlap between CRS spectroscopy and lensing-quality deep imaging is about three times that currently planned for DESI, thus enabling compelling and competitive science.

Specific scientific goals

Testing gravitational physics with overlapping lensing and spectroscopy
 Weak gravitational lensing and galaxy peculiar velocities imprinted in redshift-space distortions are complementary observables for testing the cosmological model because they probe different combinations of the metric potentials.

The overlapping datasets created by the 4MOST CRS are particularly beneficial for these tests (Kirk et al., 2015) because: (1) they allow for the additional measurement of galaxy-galaxy lensing, which is subject to a lower level of systematics than cosmic shear; (2) measurements of quasar magnification bias can be compared with these other lensing measurements and redshift-space distortion analyses in the same volume; (3) imaging can mitigate key redshift-space distortion systematics by constraining galaxy bias models; and (4) the same density fluctuations generate both the lensing and clustering signatures, thus potentially reducing statistical uncertainties.

Source redshift distributions via cross-correlations

Weak gravitational lensing is one of the most powerful and rapidly developing probes of the cosmological model, being particularly advanced in the southern sky thanks to imaging surveys such as KiDS, DES, and LSST. A principal source of systematic error for cosmic shear tomography is the calibration of the source redshift distribution which enters the cosmological model. Different methods of calibrating this distribution exist and usually they require spectroscopic overlap, which should, however, be deep enough. The planned 4MOST galaxy and quasar redshift surveys will allow for this calibration to be accomplished up to high redshifts for all overlapping imaging surveys in the southern sky.

Synergies with CMB experiments

As the only planned large southern spectroscopic survey at intermediate redshifts, 4MOST is uniquely positioned for synergies with CMB Stage 4 experiments mapping the CMB across the southern hemisphere with unprecedented resolution and accuracy. The CMB contains a wealth of information about the late-time cosmic evolution through its interactions with the large-scale structure. Of particular importance are the Sunyaev-Zel'dovich and integrated Sachs-Wolfe effects, and weak gravitational lensing of the CMB. CRS will provide growth-rate measurements by allowing cross-correlation with spectroscopically confirmed targets.

Auxiliary science

Large-scale structure mapping

CRS will offer a spectroscopic view of both large and small scales of the cosmic web. In particular, its high galaxy number density will allow structural studies of voids down to relatively small scales over a wide redshift range. At larger scales, CRS will further enable cosmological distance and effective expansion rate measurements accurate to 1–5% to be made in bins of $dz = 0.1$ up to $z = 3.5$ using galaxies and quasars, complementing DESI BAO measurements in the northern hemisphere. The CRS Ly α survey will exploit the higher spectral resolution compared to DESI (by a factor of almost 2) to measure structure in the Ly α forest down to sub-Mpc scales, allowing new limits to be placed on warm dark matter models as well as high-redshift BAO measurements (for example, Bautista et al., 2017). Combined with chronometric measures of the effective expansion rate, these BAO distances will also provide tests of average curvature and effective expansion rate consistency (for example, Clarkson et al., 2008), to test the standard hypothesis that comoving space is rigid (Roukema et al., 2015).

Synergies with other surveys

Cross-correlation of large-scale HI intensity maps across the southern sky with optical spectroscopy will allow the evolution of the neutral hydrogen content of galaxies to be mapped in detail, paving the way to surveys with the SKA (Wolz et al., 2017). CRS cross-correlations with overlapping optical and eROSITA X-ray imaging will allow us respectively to measure the effect of quasar feedback on the local clustering environment and to investigate novel routes to cosmological parameters (for example, Risaliti & Lusso, 2018). CRS, in conjunction with the 4MOST TIDES Survey (Survey 10; Swann et al., p. 58), can map the host-galaxy redshifts of a significant population of SNe discovered by LSST, allowing precise gravitational tests using peculiar velocities (Howlett et al., 2017). CRS will also be a valuable tool to follow up the numerous galaxy-galaxy strong lensing events found by Euclid and LSST (Collett, 2015), which can be used as probes for the dark matter distribution at galactic scales.

Science requirements

- The minimum survey area needed is 6000 square degrees. The minimum survey area for photometric redshift calibration is 1000 square degrees.
- The minimum required target densities for each target category (Bright Galaxies — BG, Luminous Red Galaxies — LRG, Emission-Line Galaxies — ELG, Quasars — QSO) are defined such that clustering measurements are not limited by Poisson noise.
- We require a spectroscopic success rate (SSR) > 95% for BGs, > 75% for LRGs, > 80% for ELGs and > 50% for QSOs.

The survey area is required to be as wide as possible, a requirement driven by carrying out the best measurements and covering all of the existing high-quality imaging in the southern hemisphere from DES and KiDS. The minimum area of 6000 square degrees (current baseline at 7500 square degrees) is based on ensuring a much wider area (and therefore a strong impact) for CRS compared to the planned overlap area of 3000 square degrees for DESI at $z < 0.7$, where targets have the strongest galaxy-galaxy lensing signal and are best placed to lens sources in DES and KiDS. The latter two requirements are there to ensure sample-variance-limited measurements on large scales and for the efficiency of the survey; these are based on previous experiments with similar target types (for example, eBOSS).

Target selection and survey area

Cross-correlation with deep lensing and CMB surveys motivates the use of LRG as the most efficient tracers of large-scale structure with the maximal lensing imprint. These targets should span a range of redshifts where the lensing geometry is most efficient and cosmological physics is dark-energy dominated, i.e., $z < 0.7$. Photometric redshift calibration by cross-correlation requires full redshift coverage to the limit of the source sample, where each target class covers at least 1000 square degrees (Newman et al., 2015).

Table 1. Properties of each target category in CRS.

| Name | z | Selected (AB) magnitude range | R -band (magnitude [AB]) | Sky area (deg ²) | Density (deg ²) | Colour selection | Redshift completeness | Number of targets (10 ⁹) |
|-----------------|----------|-------------------------------|----------------------------|------------------------------|-----------------------------|--------------------|-----------------------|--------------------------------------|
| BG | 0.15–0.4 | $16 < J < 18$ | 20.2 ± 0.4 | 7500 | 250 | $J-K_s, J-W1$ | 95% | 1.88 |
| LRG | 0.4–0.7 | $18.0 < J < 19.5$ | 21.8 ± 0.7 | 7500 | 400 | $J-K_s, J-W1$ | 75% | 3.00 |
| ELG | 0.6–1.1 | $21.0 < g < 23.2$ | 23.9 ± 0.3 | 1000 | 1200 | $g-r, r-i$ | 80% | 1.20 |
| QSO | 0.9–2.2 | $g < 22.5$ | 22.2 ± 0.7 | 7500 | 190 | $g-i, i-W1, W1-W2$ | 65% | 1.43 |
| QSO-Ly α | 2.2–3.5 | $r < 22.7$ | 22.2 ± 0.7 | 7500 | 50 | $g-i, i-W1, W1-W2$ | 90% | 0.38 |

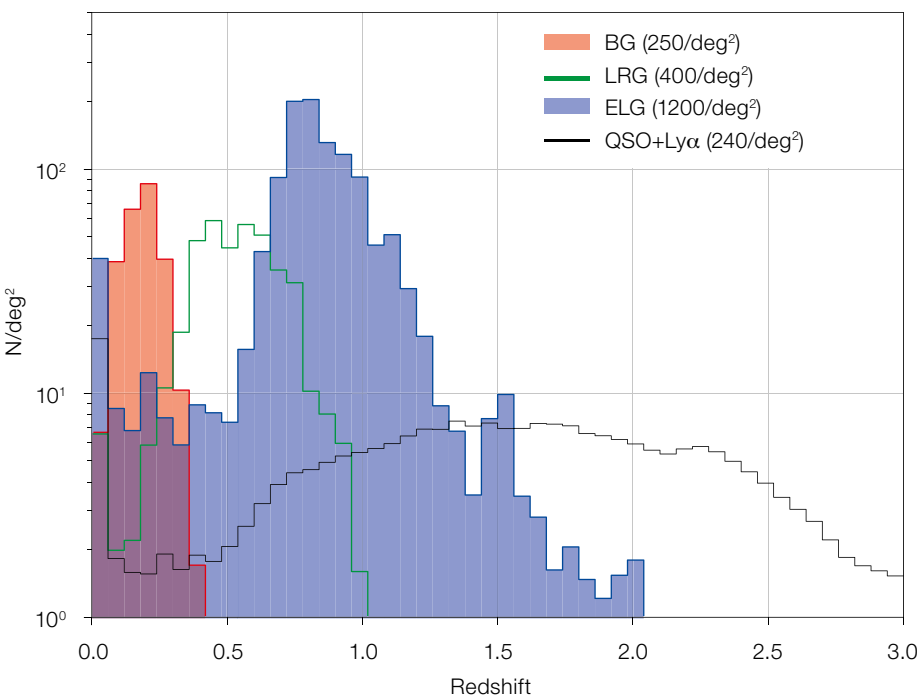
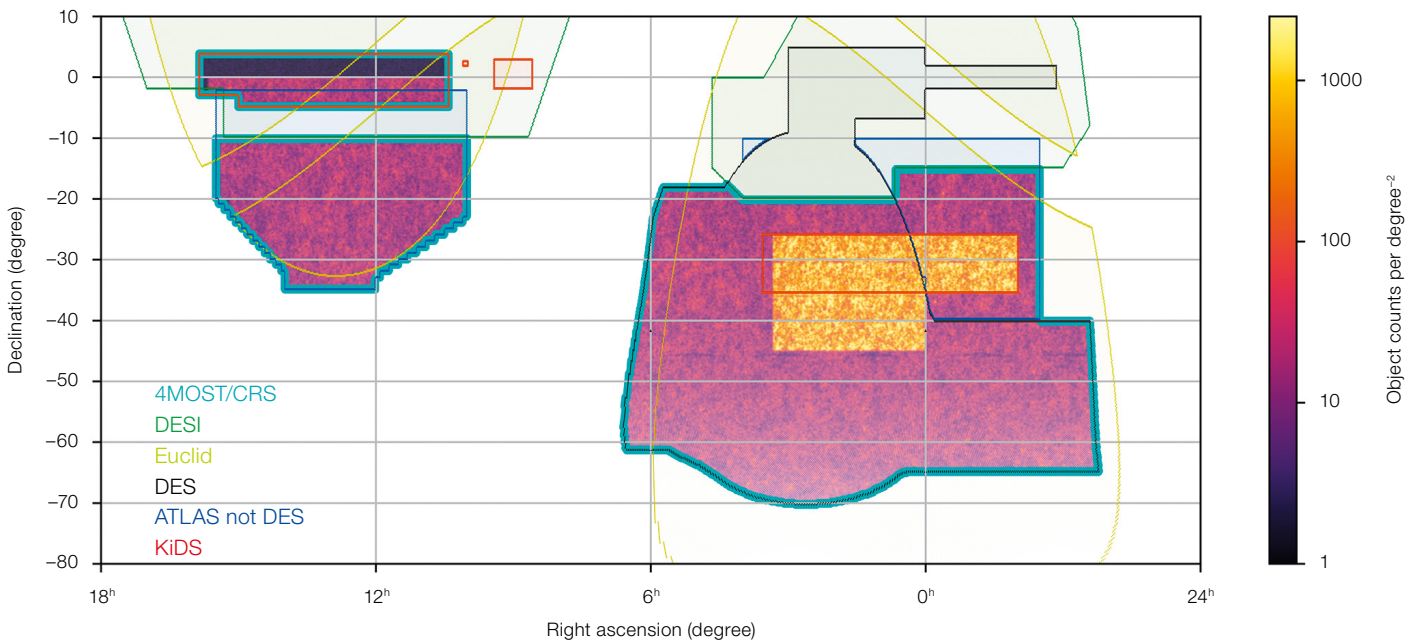

Figure 1 (above). Footprints of the discussed imaging surveys and target densities from mock catalogues. The CRS area (7500 square degrees), demarcated by a thick cyan line, consists of DES and VST-ATLAS excluding DESI and of the two main KiDS regions. The 1000 square degrees covering ELGs is shaded in yellow, with a higher target density.

Figure 2 (left). The expected redshift distributions for the different tracers. These are obtained by applying our target selection on real data, using the HSC photometric redshifts for the BG/LRG/ELG, and using SDSS DR14 spectroscopic redshifts for the QSO.

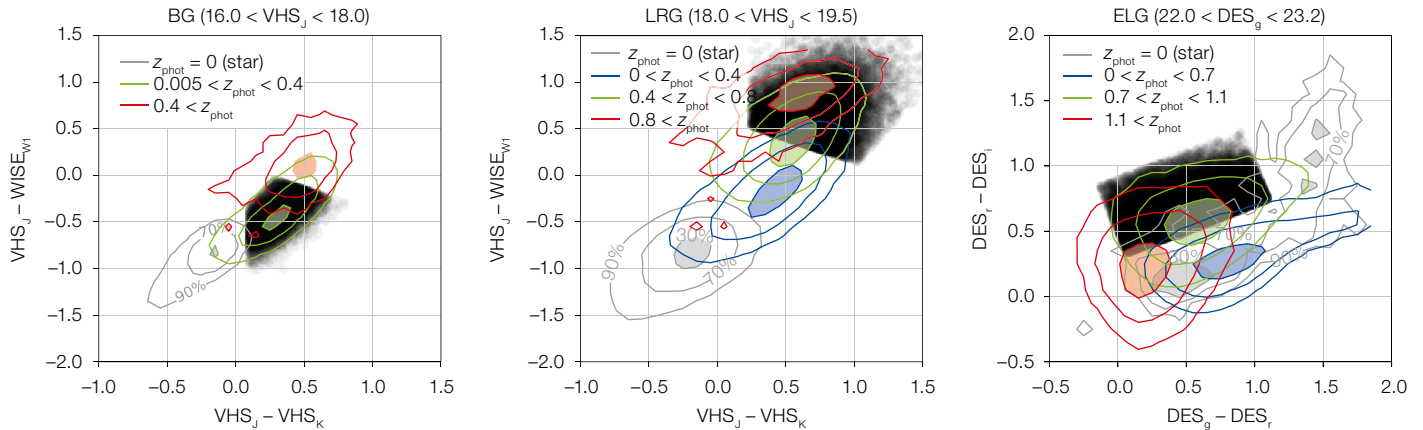

Figure 3. Colour selection for the BG (left), LRG (middle), and ELG (right), using real data (VHS, DES, and the CFHT Legacy Survey photometric redshifts). For each tracer, we display the typical loci of the objects passing the magnitude cut reported in the title: grey contours are for stars, blue/green/red contours are for objects with redshifts lower/within/higher than the aimed redshift range; our selections are shown using black semi-transparent dots.

Targets from the CRS are therefore divided into the following subcategories: BG, LRG, ELG, QSO, including quasars probed through their Lyman-forest at $z > 2.2$ (QSO-Ly α). This allows the survey to cover targets at all redshifts from $z = 0$ to $z = 3.5$ (Figure 2). Table 1 summarises the main properties of the magnitude and colour selections.

There are two main survey regions: one larger area of 7500 square degrees for BG, LRG, QSO and QSO-Ly α targets, and a smaller region of 1000 square degrees for ELGs (included in the larger one). The baseline sky area (7500 square degrees) for CRS is constructed by combining the DES, KiDS and VST-ATLAS area which are not covered by DESI (Figure 1). The 1000-square-degrees area for ELG targets is chosen within the best quality imaging region (KiDS-S and DES, Figure 1). There is almost no overlap in ELG targets with the 4MOST WAVES Survey (Driver et al., p. 46), which targets lower redshift sources.

To achieve the 4MOST CRS science goals, it is important to reach a sufficiently large target density in each target category. This density directly translates into a magnitude range in the photo-

metric selection. In addition, colour selections are applied to each target based on empirical regions in the colour-colour diagrams. The colour selections are based on the availability of the relevant filters in the imaging data contained in each region (combining DES as well as the VISTA Hemisphere Survey [VHS] and WISE). The selections foreseen are tuned to obtain the desired target density, maximising the fraction of targets in the desired redshift range and favouring a certain type of objects (red for BG and LRG, blue for ELG, see Figure 3).

Spectral success criteria and figure of merit

We use the following spectral success criteria to estimate the usefulness of a given target to achieve our science goals:

- **BG and LRG:** median signal-to-noise $S/N > 1$ per \AA in continuum region 4000–8000 \AA .
- **ELG:** $S/N > 0.5$ per \AA in continuum region near 6700 \AA or 9000 \AA .
- **QSO low-z:** $S/N > 1$ per \AA in continuum region near 6700 \AA .
- **QSO Lyman-alpha:** $S/N > 0.1$ per \AA in Lyman-alpha forest.

These spectral success criteria are very similar to the ones used for the eBOSS survey (for example, Comparat et al., 2016) and correspond to our goal of reaching a certain redshift completeness at the faintest magnitudes (Table 1).

The figure of merit accounts for the achieved surface density of successful targets and its homogeneity over a large

area, which is the main criterion for high accuracy in clustering, as well as the high total number of targets N . Each part is equally accounted linearly in the figure of merit calculation.

Acknowledgements

We acknowledge support from the French Programme National Cosmologie Galaxies (PNCG), the ERC starting Grant 336736-CALENDS and the ERC advanced Grant 740021-ARTHUS.

References

- Bautista, J. E. et al. 2017, *A&A*, 603, 12
 Clarkson, C. et al. 2008, *Physical Review Letters*, 101, 011301
 Collett, T. E. 2015, *ApJ*, 811, 20
 Comparat, J. et al. 2016, *A&A*, 592, 121
 Howlett, C. et al. 2017, *ApJ*, 847, 128
 Kirk, D. et al. 2015, *MNRAS*, 451, 4424
 Newman, J. A. et al. 2015, *Astroparticle Physics*, 63, 81
 Risaliti, G. & Lusso, E. 2018, *Nature Astronomy*, arXiv:1811.02590
 Roukema, B. F. et al. 2015, *MNRAS*, 448, 1660
 Wolz, L. et al. 2017, *MNRAS*, 470, 3220

Links

- ¹ Dark Energy Spectroscopic Instrument (DESI): www.desi.lbl.gov
² Euclid: <https://www.euclid-ec.org>
³ Taipan Galaxy Survey: <https://www.taipan-survey.org>
⁴ Dark Energy Survey (DES): <https://www.darkenergysurvey.org>
⁵ Kilo-Degree Survey (KiDS): <http://kids.strw.leidenuniv.nl>
⁶ Large Synoptic Survey Telescope (LSST): <https://www.lsst.org>

4MOST Consortium Survey 9: One Thousand and One Magellanic Fields (1001MC)

Maria-Rosa L. Cioni¹
 Jesper Storm¹
 Cameron P. M. Bell¹
 Bertrand Lemasle²
 Florian Niederhofer¹
 Joachim M. Bestenlehner³
 Dalal El Youssoufi¹
 Sofia Feltzing⁴
 Carlos González-Fernández⁵
 Eva K. Grebel²
 David Hobbs⁴
 Mike Irwin⁵
 Pascale Jablonka⁶
 Andreas Koch²
 Olivier Schnurr^{1,7}
 Thomas Schmidt¹
 Matthias Steinmetz¹

¹ Leibniz-Institut für Astrophysik Potsdam (AIP), Germany

² Zentrum für Astronomie der Universität Heidelberg/Astronomisches Rechen-Institut, Germany

³ Physics and Astronomy, University of Sheffield, UK

⁴ Lund Observatory, Lund University, Sweden

⁵ Institute of Astronomy, University of Cambridge, UK

⁶ Laboratoire d'astrophysique, École Polytechnique Fédérale de Lausanne, Switzerland

⁷ Cherenkov Telescope Array Observatory, Bologna, Italy

The One Thousand and One Magellanic Fields (1001MC) survey aims to measure the kinematics and elemental abundances of many different stellar populations that sample the history of formation and interaction of the Magellanic Clouds. The survey will collect spectra of about half a million stars with $G < 19.5$ magnitudes (Vega) distributed over an area of about 1000 square degrees and will provide an invaluable dataset for a wide range of scientific applications.

Scientific context

During the last decade, our view of the Magellanic Clouds has changed significantly. These galaxies most likely approached the Milky Way only a few Gyr ago, rather than having orbited around it for a Hubble time (for example, Kallivayalil

et al., 2013). This has motivated many studies aimed at explaining the structure and the star formation history of the Large Magellanic Cloud (LMC), the Small Magellanic Cloud (SMC) and their tidal features, i.e., the Magellanic Bridge and Stream. Furthermore, with the increased number of deep imaging observations we have discovered potential satellite galaxies of the Magellanic Clouds and new stellar streams possibly associated with tidal stripping events (for example, Koposov et al., 2018).

The Magellanic Clouds are the largest and most massive satellite galaxies of the Milky Way. The LMC resembles a spiral galaxy, with a rotating disc, an off-centre bar, and a few spiral arms. Young, intermediate-age and old stars show different levels of substructures extending to large radii. The LMC hosts the most massive stars known today (for example, Bestenlehner et al., 2014). The SMC is a dwarf spheroidal galaxy, with a significant depth along the line of sight and a morphology shaped by tidal interactions (for example, Niederhofer et al., 2018). The SMC formed half of its stellar mass prior to an age of ~ 6 Gyr (for example, Rubele et al., 2018). The Magellanic Bridge is the product of an LMC–SMC collision ~ 200 Myr ago; it is likely formed of SMC material and it contains both gas and stars. The origin of the Magellanic Stream, which is made of both LMC and SMC gas (for example, Richter et al., 2013), depends on the orbital history of the Magellanic Clouds and their one-to-many interactions with the Milky Way and with each other.

Large amounts of telescope time have been invested in imaging the Magellanic Cloud stars, studying their distribution, and measuring their ages, distances, and motions. A major ESO programme, that will provide targets for spectroscopic follow-up studies, is the VISTA survey of the Magellanic Clouds system (VMC¹), aimed at deriving the spatially resolved star formation history and three-dimensional geometry of the system. The VMC is the most sensitive high-spatial-resolution survey of the Magellanic Clouds in the near-infrared to date. The VMC and other contemporary surveys in the optical domain, such as the SMC in Time: Evolution of a Prototype interacting late-type dwarf galaxy (STEP), the Survey of the

Magellanic Stellar History (SMASH), and the Optical Gravitational Lensing Experiment (OGLE), were made possible by the development of wide-field cameras at telescopes dedicated to survey observations for a large fraction of the available time.

Next to this wealth of photometric observations, which have yet to reach their full exploitation (also including data from the Gaia satellite), there is a pronounced lack of spectroscopic observations across the range of stellar populations and substructures of the Magellanic Clouds. The largest samples of moderate resolution (at least $R = 4000$) spectra, suitable for kinematics and metallicity measurements, comprise about 9000 giant stars (for example, Dobbie et al., 2014). Chemical tagging, a powerful tool to discern the history of stellar populations, requires high-resolution (at least $R = 20\,000$) spectra and these only exist for about 4000 giant stars and 1300 early-type massive stars, and for much smaller samples of other stellar types (for example, Nidever et al. 2019). Despite the major scientific advances of these programmes, where two thirds of the spectra refer to LMC stars and one third to SMC stars, they are far from providing a comprehensive view of a system where stars span the age range of the Universe and that is strongly shaped by dynamical interactions.

Specific scientific goals

The 1001MC survey aims are as follows:

- To find and characterise kinematic and chemical patterns within the Magellanic Clouds system.
- To study links between kinematics and chemical patterns as well as their spatial distribution across different stellar populations.
- To establish how the star formation history and the dynamical evolution of the system are related to these patterns.
- To study the metallicity-dependent physical and wind properties of massive stars and their evolutionary stages.
- To quantify the metallicity dependence of key distance indicators.

A comprehensive study of the kinematics and chemistry of a large number of stars at different evolutionary phases and with

a wide spatial distribution is needed to address these goals.

Line-of-sight (radial) velocities are one of the fundamental components of motion to describe the internal kinematics of galaxies from which the distribution of mass is estimated. Radial velocities, together with proper motions, are necessary to derive space velocities from which to infer orbital motions. The 1001MC survey will provide radial velocities that match the accuracy of the tangential velocities (proper motions) that are measured using astrometry from, for example, the VMC survey (Niederhofer et al., 2018) and Gaia. These are of the order of 2.5 km s^{-1} for an ensemble of stars (which corresponds to 1% of the radial velocity of the Magellanic Clouds and is a factor of 10 smaller than the internal motion), considerably improving our capability to spatially sample kinematical substructures within the Magellanic Clouds.

The iron abundance $[\text{Fe}/\text{H}]$ is usually used as a proxy for the metallicity of stars. Age and metallicity of red giant branch stars are, however, degenerate in the colour-magnitude diagrams. Moreover, the dependence on metallicity of key distance indicators (for example, the period-luminosity relations of Cepheids, the luminosity of red clump stars) is still not well assessed. The 1001MC survey will derive the metallicity of different stellar populations, provide a metallicity map of the system as a function of age, and lift some of the degeneracies that affect the tracers of stellar population parameters. For bright stars, in addition to their radial velocity and iron abundance, we will measure the abundances of several α -elements, Fe-peak elements, and elements produced in the slow (s-) and rapid (r-) neutron-capture nucleosynthesis processes (for example, Zr, Ba, Sr, Eu), elements that will provide further constraints on the chemical enrichment history of the different components of the two galaxies. We will also classify stars throughout the Hertzsprung-Russell diagram from their spectral features. In particular we will obtain a complete census of massive stars ($> 15 M_{\odot}$) including O main-sequence stars, blue, yellow, and red supergiants and Wolf-Rayet stars. We aim also to provide some indication of the binary nature of these stars from

radial velocity variations (for example, Sana et al., 2013) and derive approximate systemic velocities of variable stars using templates, for example in the case of Cepheids, RR Lyrae stars, and long-period variables (for example, Nicholls et al., 2010).

The 1001MC survey data will also be used to quantify and map the dust absorption within the Magellanic Clouds using background galaxies. This is achieved by comparing the rest-frame spectra of galaxies with a reddening free template where the adjustment of the continuum level will provide a measure of the dust content along the line of sight (for example, Dutra et al., 2001). Compared to an ongoing study, based on the analysis of spectral energy distributions, spectra provide the redshifts of galaxies which are needed to scale the templates, reducing considerably the uncertainties associated with a photometric determination. We estimate that with 120 galaxies per square degree we would obtain a dust map with a spatial resolution of 0.143 square degrees, directly comparable to that of current star formation history studies (for example, Rubele et al., 2018).

Science requirements

The 1001MC survey aims to reach accuracies of $\pm 2 \text{ km s}^{-1}$ for the radial velocities of individual stars. This accuracy is designed to match the accuracy of the proper motion obtained with other facilities. For example, for individual bright stars in the Magellanic Clouds Gaia will provide proper motion accuracies of 2.5 km s^{-1} or obtain similar accuracies on bulk velocities from the average of about 200 G-type or 3000 M-type stars. These values have been calculated assuming the Gaia end-of-mission proper motion accuracies² and considering that at the distance of the Magellanic Clouds 0.01 milliarcseconds per year is roughly equivalent to 2.5 km s^{-1} .

We also aim to obtain metallicities for individual stars with accuracies better than $\pm 0.2 \text{ dex}$. This will be achieved using Fe lines and/or indirectly using the Ca II and Mg b triplets. Stars in the Magellanic Clouds span a relatively large range of metallicities, from about half

solar to very metal-poor ($\Delta[\text{Fe}/\text{H}] > 2 \text{ dex}$), and uncertainties in the Fe abundance of 0.2 dex or better are needed to distinguish between different stellar populations. These can be derived from spectra of individual stars, but for some faint targets the spectra will be combined to reach a minimum signal-to-noise ratio (S/N) of 20 per \AA within the spectral regions above. We aim to reach similar accuracies in measuring the abundance of other prominent elements.

A fraction of the 1001MC targets are variable stars, which means that they change temperature across the pulsation cycle. To derive elemental abundances for Cepheids it is necessary to acquire spectra before the temperature changes significantly and therefore we plan to observe for 1 hour at any given epoch, this time being sufficient to reach the required S/N. RR Lyrae stars, instead, are faint and for them we will focus on kinematics. However, we will explore the possibility of also measuring average Fe abundances by combining, for example, stars with similar metallicities as estimated from the Fourier decomposition of their light-curves.

Target selection and survey area

The 1001MC survey will cover an area of about 1000 square degrees (Figure 1). This area comprises targets that trace the extent of different stellar populations and that describe substructures throughout the Magellanic Clouds. The 1001MC survey will obtain 4MOST spectra of about half a million stars with $G < 19.5$ magnitudes and produce a sample that is a factor of 20 larger than the largest sample of Magellanic Cloud stellar spectra assembled in the past. Spectra from the Gaia Radial Velocity Spectrograph reach bright red and blue supergiant stars, while completed and ongoing observing campaigns with 2dF and APOGEE-2S observe giant stars well above the red clump in the Magellanic Clouds. The 1001MC observations will prioritise areas with the highest legacy value (i.e., the central LMC and SMC areas).

The 1001MC targets span a range of about 10 magnitudes (Table 1, Figure 2) and comprise young massive and supergiant

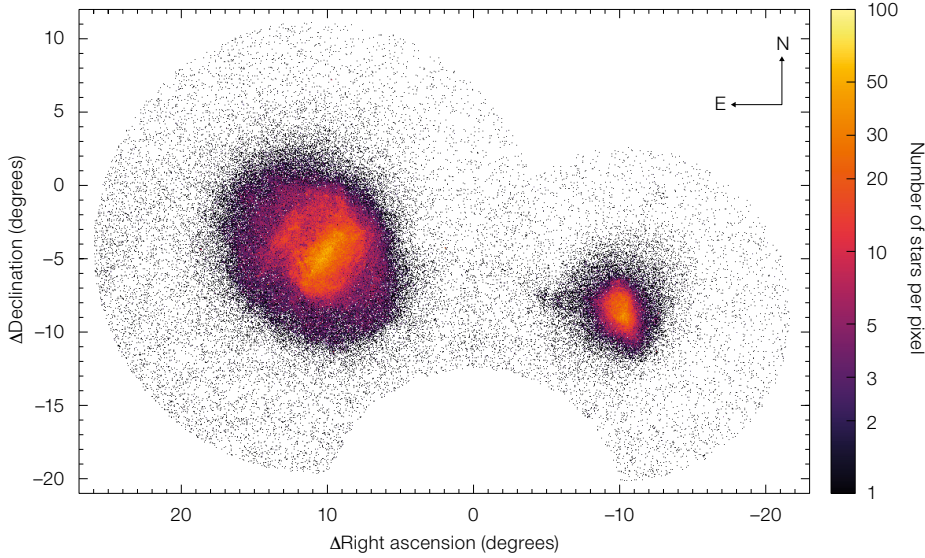

Figure 1. Spatial source density distribution of the 1001MC stars in a zenithal equidistant projection with the origin at a right ascension of 50 degrees and declination of -67.5 degrees. Pixels are 0.05 square degrees. The total area covered results from the combination of two circular regions, each centred on one of the Magellanic Clouds, that encompass their extended structure and possible tidal features. The circular cutout in the coverage at the bottom of the figure is caused by a declination > -80 degree selection limit, which was implemented because observing at lower declinations becomes really inefficient with 4MOST.

stars, intermediate-age giant stars (asymptotic giant branch stars of M and C type, red clump stars), old red giant and horizontal branch stars. They also include different types of variable stars (Cepheids of any type, long-period varia-

Table 1. Sub-surveys and preliminary numbers of 1001MC targets. For the main sequence, red clump giant and red giant branch stars, these numbers represent only fractions of the respective populations (Figure 2; LRS only): 15% for main sequence stars, 5% for red clump stars, and 10% for red giant branch stars.

| Star type | Spectrograph | Magnitude range | Number of targets (10^3) |
|--|--------------|-------------------|------------------------------|
| Main sequence stars | LRS | $11.9 < G < 19.5$ | 87 |
| Red clump giant stars | LRS | $16.9 < G < 19.5$ | 64 |
| Red giant branch (RGB) stars | LRS, HRS | $14.1 < G < 19.5$ | 310 |
| RR Lyrae stars | LRS | $12.2 < G < 19.5$ | 36 |
| Cepheids | HRS, LRS | $11.5 < G < 19.5$ | 9 |
| Supergiant stars | HRS, LRS | $10.5 < G < 19.5$ | 36 |
| O-rich asymptotic giant branch (AGB) stars | HRS | $10.8 < G < 19.5$ | 25 |
| Carbon stars | HRS | $12.4 < G < 19.5$ | 9 |
| Background galaxies | LRS | | 120 |

bles, and RR Lyrae stars). The number of targets reflects the need to statistically characterise and spatially trace substructures of the Magellanic Clouds by age, chemical content and, if possible, multiple diagnostics.

The selection of 1001MC targets results from the combination of near-infrared observations from VISTA and 2MASS with optical observations from Gaia, where variable stars are identified in OGLE and Gaia data. In particular, Gaia parallaxes are used to remove Milky Way stars and to create a catalogue with homogeneous coordinates. The VISTA selection data originate from the VMC survey for the central regions of the Magellanic Clouds and from the VISTA Hemisphere Survey (VHS) for the outer regions. VISTA data will be used to select targets for the Low-Resolution Spectrograph (LRS) while targets for the High-Resolution Spectrograph (HRS) will be selected from 2MASS. Several sub-surveys are defined to represent the range of stellar populations

within the Magellanic Clouds. Table 1 shows the approximate number of targets that belong to each sub-survey while Figure 2 shows the magnitude and colour criteria adopted to select the targets.

The central regions of the Magellanic Clouds (a few hundred square degrees) will be observed more frequently (3–6 visits) because of the high target density. This will then allow us to monitor a subset of stars across the different types. Some stars will be monitored with the HRS and others with the LRS. The main goal of these monitoring campaigns is to trace the variation in the radial velocity curves that are directly linked to the internal structure of pulsating stars and/or to the presence of companions, as well as to establish the effect of binaries on the dynamics of the different stellar systems. In addition, we will make use of the poor observing conditions programme (Guiglion et al., p. 21) for those targets that fall within the 1001MC area.

Spectral success criteria

To meet the goals of the 1001MC survey we require spectra with a S/N per \AA of about 100–1500 encompassing both LRS and HRS observations of targets distributed across the Hertzsprung-Russell diagram. Depending on stellar magnitude and type of star, we will measure elemental abundances and/or radial velocities. In practice, for the abundance of specific elements we will use spectra with S/N > 80 – 100 per \AA , while for determining indirect Fe abundances with either the Ca II and the Mg b triplets we will use spectra with S/N > 20 – 30 per \AA . From all of the other spectra of individual stars with S/N < 20 per \AA we will derive radial velocities. Furthermore, we will combine spectra of individual stars, for example RR Lyrae stars, to estimate median element abundances and radial velocity.

The S/N is measured in the continuum within one of the following spectral ranges: 5140 – 5200 \AA (including the Mg b triplet at: 5167 , 5172 , 5183 \AA) and 8350 – 8850 \AA (including the Ca II triplet at: 8498 , 8542 , and 8662 \AA). In this way there will be at least one spectral region with sufficient S/N to derive the radial velocity and some elemental abundance(s) of each star.

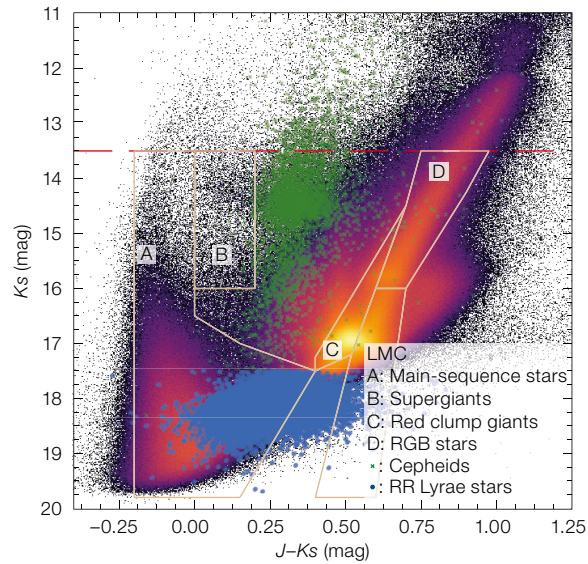
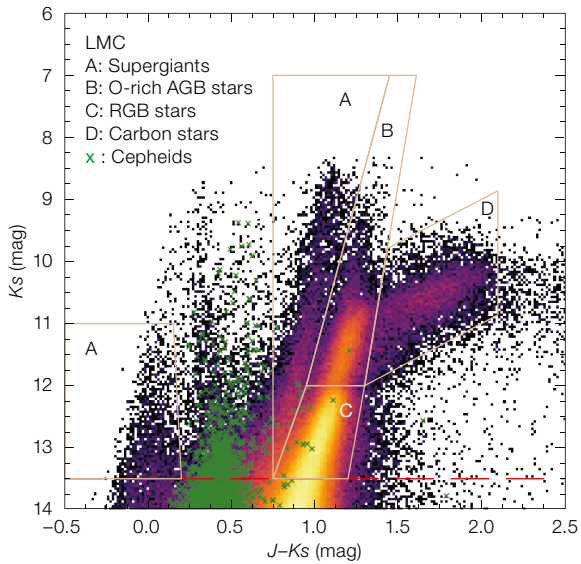

Figure 2. Near-infrared, $J-K_s$ versus K_s , colour-magnitude Hess diagrams of the 1001MC stars across the LMC (targets in the SMC are ~ 0.5 magnitudes fainter). The red dashed lines indicate the separations between the HRS targets (left) and the LRS targets (right), except for Cepheids. All sources have $G < 19.5$ magnitudes except for the RR Lyrae stars that extend to fainter magnitudes.

To estimate the progress of the 1001MC survey we define a figure of merit (FoM). The FoM for each sub-survey is the ratio of observed targets to the goal number, and the FoM for the whole survey corresponds to the minimum FoM among the sub-surveys. In this way each stellar population will be sufficiently represented across the Magellanic Clouds system.

Acknowledgements

We acknowledge funding from the European Research Council (ERC) under the European Union's Horizon 2020 research and innovation programme (grant agreement No 682115 as well as from the German Research Foundation (DFG) via Sonderforschungsbereich "The Milky Way System" (SFB 881).

References

- Bestenlehner, J. M. et al. 2014, *A&A*, 570, A38
 Dobbie, P. D. et al. 2014, *MNRAS*, 442, 1663
 Kallivayalil, N. et al. 2013, *ApJ*, 764, 161

- Koposov, S. et al. 2018, *MNRAS*, 479, 5343
 Kozłowski, S. et al. 2013, *ApJ*, 775, 92
 Nicholls, C. P. et al. 2010, *MNRAS*, 405, 1770
 Nidever, D. et al. 2019, *ApJ*, submitted
 Niederhofer, F. et al. 2018, *A&A*, 613, L8
 Richter, P. et al. 2013, *ApJ*, 772, 111
 Rubele, S. et al. 2018, *MNRAS*, 478, 501
 Sana, H. et al. 2013, *A&A*, 550, A107

Links

- ¹ VISTA survey of the Magellanic Clouds system (VMC): <http://star.herts.ac.uk/~mcioni/vmc/>
² Expected nominal science performance of the Gaia mission: <https://www.cosmos.esa.int/web/gaia/science-performance>



This VISTA image of the 30 Doradus star-forming region (or Tarantula Nebula) from the VMC Public Survey is being used to study the detailed star formation history of the Magellanic system.

4MOST Consortium Survey 10: The Time-Domain Extragalactic Survey (TiDES)

Elizabeth Swann¹
 Mark Sullivan²
 Jonathan Carrick³
 Sebastian Hoenig²
 Isobel Hook³
 Rubina Kotak^{4,5}
 Kate Maguire⁴
 Richard McMahon⁶
 Robert Nichol¹
 Stephen Smartt⁴

¹ Institute of Cosmology and Gravitation,
 University of Portsmouth, UK

² School of Physics and Astronomy,
 University of Southampton, UK

³ Physics Department, Lancaster
 University, UK

⁴ School of Mathematics and Physics,
 Queen's University Belfast, UK

⁵ University of Turku, Finland

⁶ Institute of Astronomy, University of
 Cambridge, UK

The Time-Domain Extragalactic Survey (TiDES) is focused on the spectroscopic follow-up of extragalactic optical transients and variable sources selected from forthcoming large sky surveys such as that from the Large Synoptic Survey Telescope (LSST). TiDES contains three sub-surveys: (i) spectroscopic observations of supernova-like transients; (ii) comprehensive follow-up of transient host galaxies to obtain redshift measurements for cosmological applications; and (iii) repeat spectroscopic observations to enable the reverberation mapping of active galactic nuclei. Our simulations predict we will be able to classify transients down to $r = 22.5$ magnitudes (AB) and, over five years of 4MOST operations, obtain spectra for up to 30 000 live transients to redshift $z \sim 0.5$, measure redshifts for up to 50 000 transient host galaxies to $z \sim 1$ and monitor around 700 active galactic nuclei to $z \sim 2.5$.

Scientific context

The next decade will see an unprecedented sampling of the extragalactic time-domain universe via massive photometric surveys of the sky. Follow-up spectroscopy of photometric detections is critical to extracting the full astrophysi-

cal detail of the objects discovered: their classifications, chemistry, distances (redshifts), luminosities, energetics — and ultimately their physical natures. TiDES addresses this spectroscopic challenge with 250 000 fibre-hours of spectroscopy of transients, their host galaxies, and active galactic nuclei (AGN). These measurements will allow TiDES to tackle three key science goals.

The first goal is the nature of dark energy. This is one of the most puzzling problems in physics, and studying dark energy is the goal of major ground- and space-based facilities over the next decade, for example, Euclid, the Large Synoptic Survey Telescope (LSST) and the Wide Field Infrared Survey Telescope (WFIRST). Type Ia supernovae (SNe Ia) provide a mature and well-exploited probe of the accelerating universe (for example, DES Collaboration et al., 2018), and their use as standardisable candles is an immediate route to measuring the equation of state of dark energy. LSST¹, for example, could assemble around 100 000 SNe Ia^a to $z = 1$, giving unprecedented insight into the expansion history of the Universe. But a major systematic uncertainty will be the photometric classification and redshift measurement of the supernova detections.

The second goal is to study the extragalactic transient universe. The extragalactic time-domain universe is a far more diverse environment than was imagined only a decade ago. New “superluminous supernovae”, “calcium-rich transients”, exotic thermonuclear explosions, and even the newly-discovered kilonovae (Smartt et al., 2017) have all demonstrated how little is known about explosive transient populations. LSST will enlarge all these populations by many orders of magnitude and likely uncover entirely new forms of explosions. The key to studying all of these classes of objects is spectroscopy that is rapidly prioritised, which we will implement in TiDES.

The third goal is cosmology and galaxy evolution with AGN. AGN are the most energetic sources in the Universe, showing variability at all wavebands as mass is accreted onto supermassive black holes in the centres of galaxies. The variability of the optical continuum light from

the accreting matter and its delayed response mirrored in the optical emission lines of the surrounding material, can be (i) turned into a standard candle similarly to SNe Ia, but out to higher redshifts (Watson et al., 2011) and (ii) used to directly measure the masses of the black holes (for example, Shen et al., 2016). TiDES will establish a Hubble diagram of AGN between $0.1 < z < 2.5$, providing an independent standard candle and delivering the largest catalogue of dynamically measured black hole masses on cosmological scales as a new basis for understanding galaxy evolution.

The majority of TiDES targets will come from LSST, which will produce millions of transient alerts and photometric data on hundreds of thousands of SNe and other variable objects. TiDES will exploit the fact that wherever 4MOST points in the extragalactic sky there will be known time-variable sources, both recently discovered transients, and older, now faded events. Around 30 low-resolution spectrograph (LRS) fibres (2% of the total) in every pointing will be allocated to extragalactic transients, their host galaxies, and AGN. TiDES will therefore “piggyback” on the general 4MOST survey strategy (Figure 1) and will not normally drive the pointing of 4MOST. In addition, 4MOST will regularly (twice per lunation, when schedulable) observe the four announced LSST Deep Drilling Fields (DDFs). These fields are also planned to be observed by the 4MOST WAVES survey (see Driver et al., p. 46).

Specific scientific goals

i. Spectroscopic classification of live transients (TiDES-SN)

The aim of TiDES-SN is to observe live transients discovered by LSST and other transient surveys as soon as feasible after discovery. The science goals for TiDES-SN include (i) classification of live SNe, including uncovering rare and unusual events, and (ii) construction of an optimised training sample for the photometric classifiers that will be used to assemble the next generation of SN Ia cosmological samples.

The combination of LSST discoveries and fast turnaround spectroscopic data from

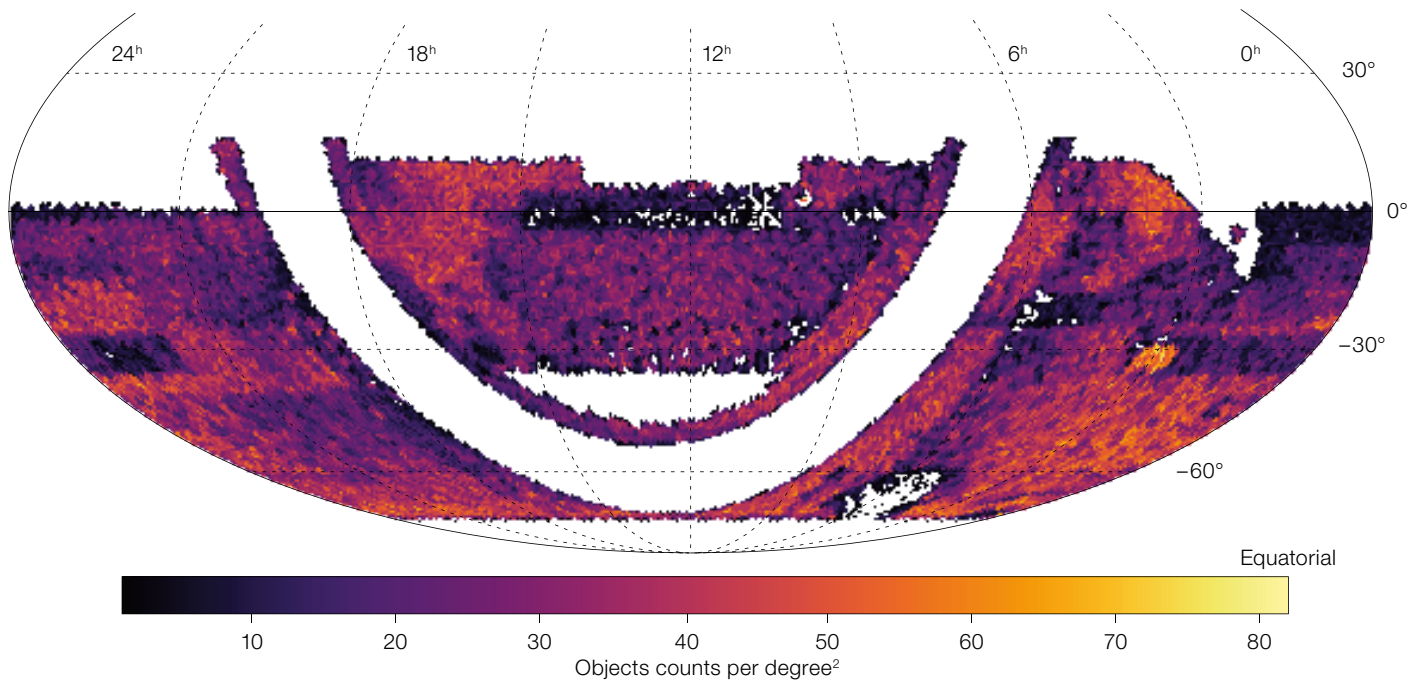

Figure 1. An example distribution of TiDES targets using an example LSST-discovered supernovae distribution as input. The colour scheme shows the typical number^a of supernovae and their host galaxies per square degree that could be targeted by TiDES. TiDES will optimise the relationship between the two surveys and ensure LSST transients are in the 4MOST queue.

TiDES-SN will naturally provide spectroscopic follow-up in the first days after explosion for large samples of transients, including both classical SN types, and more exotic events. Early-time observations (< 3–4 days from transient detection) will allow new insights into the explosion environments and outer layers of the SN ejecta. Rare, fast transients that rise and fall rapidly and that could make important contributions to galactic chemical evolution (for example, calcium-rich fast transients), will also be explored statistically for the first time. We will also target potential lensed SNe that fall within our survey fields (for example, Goldstein et al., 2018) and other transients such as tidal disruption events.

For SN Ia cosmology, even with TiDES, spectroscopic resources are not available to target all candidate SNe Ia, and photometric classification techniques are therefore critical for future SN Ia cosmological analyses. But even the most advanced machine-learning classification

techniques are fundamentally dependent on large, homogenous and representative training samples (Lochner et al., 2016). Although TiDES-SN cannot provide a complete sample of SNe, it can provide an unbiased sampling of the whole SN population down to $r = 22.5$ (AB) magnitudes. When combined with the optical (LSST) light curves, this will provide an unsurpassed training sample for future photometric classifiers.

ii. Spectroscopy of supernova host galaxies (TiDES-Hosts)

With TiDES, we will obtain spectroscopic redshifts for host galaxies of SNe that have faded away. This will provide: (i) the SN redshifts required for LSST SN Ia cosmology (see the LSST Dark Energy Science Collaboration Document by Mandelbaum et al., 2018); (ii) improvements in SN photometric classification via the use of spectroscopic redshift priors in the classification algorithms; and (iii) detailed spectral information on the brighter host galaxies, such as metallicity and star formation rates. 4MOST should reach $r = 22.5$ magnitudes in two hours for galaxy redshifts. This limit will be fainter in the deep fields, where our repeat observations will allow the stacking of many hours of spectra. Our model is the Australian Dark Energy Survey (OzDES), a programme at the Anglo-

Australian Telescope using the AAOmega spectrograph with the 2dF multi-object fibre positioner, which conducted deep spectroscopic observations of the host galaxies of SNe discovered in 27 square degrees of imaging from the Dark Energy Survey (Childress et al., 2017). 4MOST is expected to obtain host galaxy redshifts for at least 10 times as many SNe Ia, discovered out to $z \sim 1$.

iii. Repeat spectroscopic observations of AGN for reverberation mapping (TiDES-RM)

The primary goal of TiDES-RM is to use AGN broad-line lags to build a Hubble diagram out to $z = 2.5$, and to constrain the cosmological equation of state. AGN as standardisable candles are complementary to SNe Ia, with a redshift distribution that extends to higher redshift. In addition, by using two independent standard candles, TiDES will be insensitive to systematic errors in any individual method, thus increasing the reliability of the results. This will be particularly important when constraining the equation of state of dark energy. Our goal is to extend the redshift range of current surveys, and to exceed the state of the art in early 2020 by at least a factor of two for reverberation-mapped AGN (King et al., 2015). This leads us to target around 700 AGN over the redshift range $0.1 < z < 2.5$.

As a secondary science goal, we will be measuring dynamical masses of supermassive black holes in AGN out to $z \sim 2.5$. Black hole mass is a key parameter in understanding galaxy evolution. Most current black hole mass measurements outside the local universe rely on indirect relations between black hole mass and galaxy properties, for example the M-sigma relation (i.e., the correlation the mass of the supermassive black hole and stellar velocity dispersion). These methods are prone to biases depending on the spatial resolution, which becomes increasingly problematic at higher redshifts. Reverberation-mapped black hole masses have become a standard in the local universe, and we will now push this out to the early universe.

Science requirements

The science requirements for the three sub-surveys are as follows.

TIDES-SN: Our main requirement to deliver our live transient science is a turnaround time from transient discovery to implementation in the 4MOST schedule of $< 3\text{--}4$ days. Other requirements include a knowledge of the 4MOST pointings well in advance (> 7 days) of a field's being observed, facilitating a smooth link with our transient discovery surveys, and allowing us to focus our target selection on transients in defined areas of the sky. We aim for 30 000 live transient observations, generating datasets large enough to construct a meaningful training sample for photometric classifiers, and statistical samples of rare events.

TIDES-Hosts: Wherever 4MOST points, LSST will have previously discovered SNe in the field. We will put a 4MOST fibre on the host galaxy to measure a redshift. Our target is at least 50 000 successful host galaxy redshifts, which will enable the largest sample of cosmological SNe Ia by at least a factor of 10.

TIDES-RM: The reverberation mapping survey is built on repeat observations in pre-defined and well established LSST extragalactic deep fields that are shared among several Galactic and extragalactic 4MOST surveys. We created an AGN mock catalogue based on the redshift-

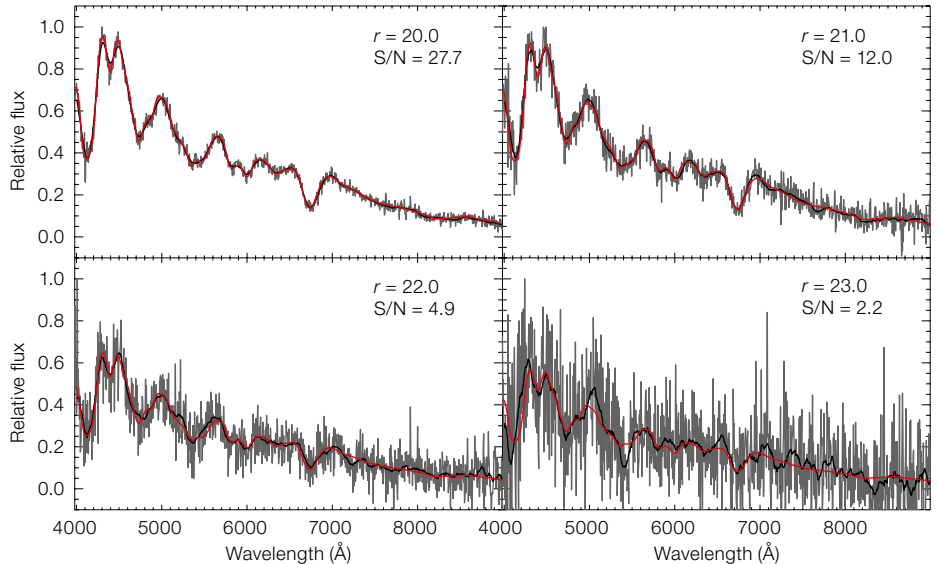

Figure 2. Mock 4MOST spectra based on the 4MOST ETC. Shown here is a maximum-light spectrum of a SN Ia at redshift $z = 0.2$ after “observation” by 4MOST over a series of r -band magnitudes, and rebinned to 5 \AA (light grey). The mock spectra are calculated assuming an exposure time of 3×1200 seconds, average conditions (seeing = 1.1 arcseconds, airmass = 1.3) in dark time, and with 2% sky subtraction residuals. The black lines are the (weighted) Savitzky-Golay filtered mock spectra, and the red spectra show the original template for comparison. The mean S/N per 15 \AA bin over $4500\text{--}8000 \text{ \AA}$ is also given.

dependent luminosity function of AGN and simulated C IV and H β emission line lags based on established lag-luminosity relations. Based on these lags, a five-year survey duration and the 4MOST signal-to-noise (S/N) estimate for grey time, we determine the required cadence of observations and exposure time per epoch to recover lags for at least the targeted 700 AGN. We find that we require one-hour exposures, corresponding to objects with $r < 21$ magnitudes, and a typical cadence for repeat observations of 14 ± 4 days over an observing semester for each LSST Deep Drilling field.

Target selection and survey area

TIDES will target the extragalactic fields of major time-domain experiments in the southern hemisphere. We anticipate our principal source of targets to be LSST. This will include both the wide-area LSST deep-wide-fast survey (particularly those

areas that have a “rolling cadence”), as well as the narrow-area DDFs. We also require repeat observations of these DDFs. At the time of writing, the LSST observing strategy and survey area have not been finalised, particularly with regard to cadence optimisation, and this will evolve over the coming months and years. As a result, the exact numbers in this section should only be regarded as indicative.

The current TIDES-SN strategy is to target all bright ($r < 22.5$ magnitudes) live transients in a 4MOST field. We expect there to be of order $5\text{--}10^a$ such transients in any 4MOST extragalactic field on any one night. Over five years with 180 dark/grey nights for extragalactic observations per year, this equates to $\sim 30\ 000$ live transients. These targets will be selected in a “blind” fashion, i.e., TIDES-SN will not use colour or other cuts to preferentially select from these objects. However, we will use colour selection or contextual information to prioritise additional interesting, unusual or very early transients that may be fainter than $r = 22.5$ magnitudes.

TIDES-Hosts will preferentially select SNe with a full (LSST) light curve. The number of such hosts will increase with time as LSST builds up the variability history for each field. Simulations using the exposure time calculator (ETC) show that, for a typical SN Ia host galaxy, we expect to be able to obtain a redshift from a spectrum with $S/N > 2$ per \AA . We anti-

pate successful redshift measurements for galaxies approximately 2 magnitudes fainter after 10 hours of exposure time before reaching the Poisson limit, a technique adopted by OzDES (Childress et al., 2017).

TiDES-RM will pre-select targets from known AGN in the LSST Deep Drilling fields with a final selection based on their variability history in LSST. The LSST commissioning data preceding 4MOST will be used, with semi-annual updates of monitoring catalogues as LSST builds up a longer time baseline. We will then take one initial spectrum for each candidate AGN to assess whether the emission line profile is suitable for reverberation mapping. If broad lines are detected with $S/N > 10$ per 15 \AA bin in a single 1-hour exposure, the AGN will be monitored until a lag can be determined (depending on luminosity and redshift, this may take between six months and five years), at which point, if feasible, they will be replaced by new sources to maximise the number of measured lags. We require repeat observations of typically one hour, with a cadence from 14 days to 42 days, depending on redshift and luminosity. Based on a mock catalogue selected from the OzDES quasar sample (Tie et al., 2017) of AGN with $r < 21.0$ magnitudes, the expected total execution time will be approximately 25 000 fibre-hours. We note that a sizeable fraction of the AGN monitored by TiDES are also likely targets of the 4MOST AGN survey (S6; see Merloni et al., p. 42).

Spectral success criteria and figures of merit

Our qualitative spectral success criteria (SSC) are: a successful transient classification (TiDES-SN); a successful redshift measurement (TiDES-Hosts); and a successful AGN spectrum taken (TiDES-RM). The first two criteria are difficult to quantify.

For TiDES-SN, the success will depend on the S/N in the 4MOST spectrum, the transient type (and hence spectral features), and the amount of “contaminating” light from the transient host galaxy. Supernova spectra are dominated by broad features many tens of Angstroms

wide, and thus our SSC are defined using S/N in 15 \AA bins. Our criteria are based on earlier studies of high-redshift SNe Ia (Balland et al., 2009), where a robust classification can be achieved with a mean $S/N = 10$ per 15 \AA over $4500\text{--}8000 \text{ \AA}$ in the observed frame. This is a conservative success criterion; Balland et al. (2009) demonstrate probable classifications of transients with a mean $S/N = 3$ per 15 \AA . We have also conducted initial simulations using the 4MOST ETC to check our likely classification limits for SNe Ia. We use the ETC to output mock “observed” SN Ia spectra (Figure 2) and attempt a classification with the machine-learning SN classification tool DASH (Muthukrishna et al., in preparation). DASH can classify, with 95% confidence, an $r = 22.2$ magnitudes SN Ia ($z \sim 0.45$) with spectra of $S/N = 6$ per 1.5 \AA bin without using the host redshift as a prior. These simulations were performed with SN spectra free of host galaxy contamination and with “perfect” sky subtraction.

For TiDES-Hosts, we require a $S/N \geq 3$ per \AA over $4500\text{--}8000 \text{ \AA}$ based on the OzDES survey, which has obtained more than 1700 redshifts with a 95% confidence level of host galaxies with this S/N . Based upon the OzDES project we expect a redshift success rate of approximately 70% for a galaxy with magnitude brighter than $r = 24$ magnitudes in a two-hour exposure. For TiDES-RM, spectral success is defined by achieving a $S/N = 10$ per 15 \AA bin for an AGN spectrum within a predefined cadence.

Our figures of merit (FoMs) encapsulate our broad goals — as many observations of transients and their hosts, and as many time lags measured as possible, for use in astrophysical and cosmological analysis. Our total FoM function is a weighted sum of the three sub-surveys. For TiDES-Hosts and TiDES-SN, the SSC is represented by the error function, with a dependence on the number of objects targeted by 4MOST. For TiDES-RM, the FoM is equal to $x^{1.7}$, where x is the ratio of successfully observed AGN epochs divided by the total number of AGN epochs requested. This functional form captures the fact that no time lag can be determined with fewer than $\sim 50\%$ of the requested epochs being successfully

observed. While technically this applies for each individual source, the survey average is a good measure of the typical number of epochs observed for a source in the survey.

Acknowledgements

TiDES acknowledges funding from Queens University Belfast, Lancaster University, the University of Portsmouth and the University of Southampton.

References

- Balland, C. et al. 2009, A&A, 507, 85
- Childress, M. et al. 2017, MNRAS, 472, 273
- DES Collaboration et al. 2018, ApJL, arXiv:1811.02374
- Goldstein, D. A. et al. 2018, ApJS, submitted
- King, A. L. et al. 2015, MNRAS, 453, 1701
- Lochner, M. et al. 2016, ApJS, 225, 31
- Mandelbaum, R. et al. 2018, arXiv:1809.01669
- Shen, Y. et al. 2016, ApJ, 818, 30
- Smartt, S. J. et al. 2017, Nature, 551, 75
- Watson, D. et al. 2011, ApJ, 740, 49

Links

- ¹ The Large Synoptic Survey Telescope: <https://www.lsst.org/>

Notes

- ^a The exact number will depend on the final LSST observing strategy and implementation.



Above: Participants in the Fifth ELT Management Advisory Committee in between discussions on the current status of the ELT instruments.

Below: Members of the ESO Adaptive Optics Facility (AOF) team at the ESO Supernova Planetarium & Visitor Centre. The team was awarded the 2018 Paul F. Forman Team Engineering Excellence Award by the Optical Society (OSA).

Both images: ESO/M. Zeman



The New ESO Phase 1 System

ESO Phase 1 Project Team¹

¹ ESO

ESO announces the forthcoming deployment of its new tool for the preparation and submission of observing proposals. This represents the first part of a broader overhaul of the ESO Phase 1 system (p1) that, in the near future, will also entail a significant modernisation of the Observing Programmes Committee (OPC) refereeing process and related tools.

The new p1 system is web-based, resembling the new p2 tool. This system includes many new features including: allowing the Principal Investigator and Co-Investigators (Cols) to edit proposals in a collaborative way; graphically plotting target visibilities and the probability of realising the requested observing conditions; retrieving target information directly from Simbad¹; and updating a submitted proposal (before the deadline). There are also some practical implications: each of the Cols will need to have an ESO User Portal account², and it will no longer be possible to directly resubmit

existing LaTeX proposals into the new system. Finally, the ESIFORM package — which served the community for decades — will be retired.

Please stay tuned, as there will be further announcements related to the new p1 system and its rollout via the usual ESO communication channels.

Links

¹ Simbad: simbad.u-strasbg.fr/simbad

² ESO User Portal: www.eso.org/UserPortal

DOI: 10.18727/0722-6691/5131

Fellows at ESO

Elyar Sedaghati

Growing up in 1980s Iran during the war, looking up at the night sky was the only thing that gave me some form of comfort and hope. You see, quite often electricity supplies of entire cities were cut for whole nights to give enemy bombers minimal visibility; a small win for my curious eyes during an otherwise desperate situation. Observing with my toy telescope, looking up at the Moon and the planets, served as a form of escapism from the ugliness of the reality unfolding around me. It is hence fair to say that I owe a lot to astronomy for carrying me through such difficult times. Fast forward a couple of decades, and fortunate enough to have escaped with my life, I found myself studying Natural Sciences at Cambridge University in the UK. While, by now, the figurative scars of war had been healed, fascination and curiosity with the heavens had very much made a permanent impression on me.

After obtaining my Bachelor's degree, with a specialisation in astronomy, I had to leave science and work in industry, both in order to deal with the financial burdens resulting from being a foreign

student in the UK, and to handle the endless complications associated with staying in the UK with my passport. Fast forward a few years; having obtained enough pieces of paper to be allowed to live in the EU, I finally went back to university and obtained my Master's degree in physics from the Freie Universität Berlin, with a thesis on the detection of exoplanetary atmospheres using ground-based facilities. It was during this thesis that I had the chance to work on some Very Large Telescope (VLT) data using the FOCal Reducer/low dispersion Spectrograph (FORS2) instrument, and I got to know ESO and Paranal through my interactions with my then long-distance supervisor, Petr Kabath, who was working at Paranal.

After that, it was only natural to continue with doctoral studies in the same field of research, which I managed to start under the supervision of Heike Rauer, the Principal Investigator for the ESA mission PLANetary Transits and Oscillations of stars (PLATO) at the German Space Agency (DLR), in Berlin. Having previously worked on FORS2 exoplanet transmission spectroscopy data — obtaining observations tracing minute variations in



Elyar Sedaghati

exoplanet transit depths that can reveal the presence of exoplanet atmospheres — I had the perfect platform to apply for an ESO studentship here in Chile. The then instrument scientist of FORS2, Henri Boffin, was planning an intervention in the optical path precisely for the purpose of improving such observations. So I applied to work with him here at ESO for a two-year project. This turned out to be the best decision I have ever made in my life, not taking for granted the gravity of such a statement.

During those two years at ESO, under Henri's supervision, I worked intensely on a number of FORS2 transmission spectroscopy datasets rigorously testing, analysing and validating the improvements that the interventions had made to the aforementioned science with this instrument. As a consequence of this we published a number of results in various journals, including the first-ever detection of a long sought-after metal oxide in the atmosphere of a giant and hot exoplanet. It was due to the efficiency with which Henri guided me through my work that I managed to fulfill the German universities' requirement for a cumulative thesis (i.e., the requisite number of first-author papers), which I defended within just over two years; much to the annoyance of the bureaucrats at DLR, who had difficulty re-routing the funding I had already secured for the third year of my PhD back in Germany.

Naturally, there was no doubt in my mind what my next step would be: an ESO Fellowship, which I started exactly a month after the day I defended my thesis. I have now been working at Unit Telescope 1 (UT1; also known as *Antu*) for over a year as the FORS2 fellow. During this time, I have loved operating and improving its instruments. I feel very privileged to be at Paranal just now; these are exciting times for the research field of exoplanetary science. The Echelle SPectrograph for Rocky Exoplanet and Stable Spectroscopic Observations (ESPRESSO) has recently started operation in single-UT mode, giving us unprecedented and unparalleled precision and accuracy in radial velocity measurements of exoplanets. Soon atmospheric results will follow. Furthermore, soon the CRyogenic InfraRed Echelle Spectrometer

instrument will be back after its upgrade (CRIRES+), which will open a further channel towards the infrared for us, enabling us to probe exoplanetary atmospheres for heavier molecular species.

I have so far absolutely loved the experience of the fellowship, where I have learned so much about the operational and technical aspects of astronomy, being at the forefront of research in other areas of astronomy, and having the freedom to explore different and new ways to detect exoplanetary atmospheres. It is this freedom in research, as well as the operational duties at Paranal, that attracted me to ESO, and I have yet to be disappointed. And this is not even mentioning having the chance to go skiing and surfing on the same day from Santiago!

So if I can summarise this piece in two short points, they would be: one, try not to be born in the Middle East (!); and two, if you have the chance to work with Henri Boffin, take it.

Anna Miotello

If you ask my daughter what my job is, she will surely say “the stars”. Actually, in the kind of data I usually handle the stars do not shine, but you can clearly see the cold gas and dust emitting at (sub-) millimetre wavelengths surrounding them while they form. I study protoplanetary discs in order to understand how planets such as our Earth and her fellow Solar System planets formed. The discs I am interested in can also be observed during the day using interferometers such as the Atacama Large Millimeter/submillimeter Array (ALMA).

At school I liked everything, ranging from philosophy to maths, from sport to art. I got interested in physics during my last year of high school, after meeting a young teacher who taught us about Einstein's special relativity theory and after visiting an exhibition about the Milky Way. There was so much I did not know about this and that I could learn, so I decided to study physics at the Università degli Studi di Milano. Towards the end of my Bachelor's degree it was clear that my interest was mainly in astrophysics



Anna Miotello

and, under the supervision of Marco Potenza (Milano) and Massimo Robberto (Space Telescope Science Institute, STScI), I carried out a thesis project on Hubble Space Telescope (HST) observations of a protoplanetary disc in the Orion star forming region to study its dust particle properties. Marco Potenza is an experimental physicist in the field of optics. His expertise on dust scattering and absorption properties was key and gave an interesting angle to our HST study. The following summer I completed this project as part of the 2011 summer program at STScI. Massimo's mentoring, together with such a high-profile international research experience — so different from anything I had previously seen in Italy — was probably the turning point that made me decide I wanted to become an astronomer. The project, in particular, was very exciting and led me to very interesting results which were then published in 2012.

After the summer, I presented these results in a poster at an ESO workshop, “Formation and Early Evolution of Very Low Mass Stars and Brown Dwarfs”. There, I met Leonardo Testi, who offered me the opportunity to carry out my Master's degree thesis at ESO in Garching.

That was the chance to work in (sub-)millimetre interferometry, a totally new technique for me, and to continue working on discs, but at a younger and still embedded phase. The goal was to understand whether dust grains, which will eventually coagulate to form planets, already start growing to millimetre sizes in the envelopes of extremely young protostars. I enthusiastically accepted and started working on that project from the theoretical point of view in Milan in 2013, under the supervision of Giuseppe Lodato. In September of the same year I moved to Garching where I learned to calibrate and image Australia Telescope Compact Array (ATCA) observations, analyse the data and model them using a radiative transfer code. This pre-ALMA experience was extremely formative as I saw with my own eyes some aspects of interferometric data that are essentially hidden to ALMA users nowadays. Also, Leonardo's experience in interferometric data and his didactic abilities helped me to concretely understand interferometry, which otherwise would have been only a set of equations.

One thing was clear: ESO was a unique place and I was really tempted to continue my education there as a PhD student through the IMPRS programme. I was, however, also offered a PhD position at Leiden Observatory by Ewine van Dishoeck, one of the world leaders in astrochemistry, specifically in the field of star and planet formation. I accepted that

position and started my PhD in June 2013, as that was the best opportunity to learn about the gas content in protoplanetary discs, very complementary to the knowledge I had already acquired on dust. I spent my first year at the Max-Planck-Institut für Extraterrestrische Physik in Garching, where I learned to carry out physical-chemical models of discs with the physical/chemical model Dust And Lines (DALI), under the supervision of its developer Simon Bruderer. In 2014 I moved to Leiden, where I continued augmenting the DALI code. The goal of my thesis was to solve "The puzzle of protoplanetary disc masses", as its title reads, by employing observations of CO isotopologues, which needed to be carefully modelled. After four years and four papers, comparing models to ALMA observations, the puzzle is not solved yet. In fact, I now understand that getting disc masses right is an even more complicated riddle than expected. Nevertheless, it is an extremely important question to answer if one wants to understand how planet formation really happens. All this work established the basis of my current research, where the interplay between gas and dust seems to be key.

In Leiden I really enjoyed the combination of high-level research and care for the students. Between the start of my PhD and the beginning of my fellowship at ESO, I have had three children. I can never thank my supervisor, Ewine, the Leiden Observatory and ESO enough for

the support they gave me. They allowed me to carry out and fully enjoy high-level research, without obliterating my personal life. In my experience, support, flexibility, trust and encouragement are key to truly enable full inclusion of women — more specifically, mothers — in astronomy.

I concluded my PhD thesis in September 2017 and I joined ESO Garching as a fellow in October that same year. It felt like coming back home. On top of enjoying the great scientific environment, as a fellow I can concretely support the observatory, and share the load — as you do in a family — with "functional work" for up to 25% of my time. Joining the ALMA Regional Centre (ARC) and working on reducing data was a natural choice. However, I decided to combine this duty with a less usual one, that is to join the editorial team of *The Messenger*. I find both activities enrich my scientific career and are unique opportunities to learn new skills.

Astronomy was born out of the astonishment of people who stared at the starry sky and asked themselves what was the link between their existence and such immensity. Visiting the ESO telescopes, one sees how far this amazement and curiosity have brought us. I feel privileged to be an astronomer and to be at ESO, and I hope that I will always be as astonished and curious as those first astronomers.

La Silla and the surrounding mountains seen at dusk.

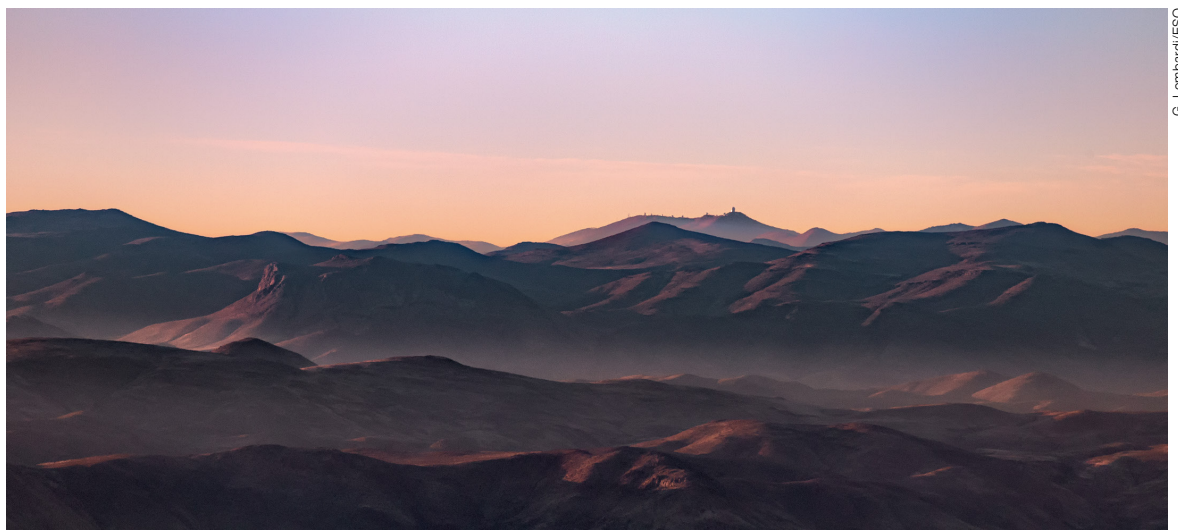

G. Lombardi/ESO

External Fellows at ESO

In addition to the ESO fellowships, a number of external fellows are hosted at ESO. A profile of one of these fellows is presented here.

Zhi-Yu Zhang

I still feel moved when I recall the moment that I happened to watch the Geminid meteor shower, on one freezing winter night in 2009, during a gap in my observations at Mount Graham in the USA. It was my first year as a PhD student when I started to learn about the Universe as much as possible. Actually, this observing trip was associated with my first successful observing proposal, which was to use the 10-metre Heinrich Hertz Submillimeter Telescope to observe dense molecular gas in external galaxies. That day was also my birthday, full of surprises and fun — just like my research career.

I was born in the mountainous southwest region of China, in the Guizhou Province, which is now well known for hosting the Five-hundred-meter Aperture Spherical radio Telescope, FAST. When I was four years old, my family moved to the eastern part of China, the Anhui province, where I spent a large portion of my childhood reading. The book series titled *“One hundred thousand Why”* enlightened me in the exploration and understanding of the principles that the world follows. Therefore, I selected particle physics for my major in my bachelor degree, at the University of Science and Technology of China (USTC) — with ambitions to understand the ultimate rules of the Universe. I was involved in research into quantum information and quantum computers, which have the potential to provide revolutionary technology for human beings.

However, after a two-year struggle with trying to understand quantum physics, I realised that it takes talent to make a real breakthrough in fundamental physics. Keeping an enthusiasm for physics, I made a life-changing decision and switched to astrophysics. Yu Gao kindly accepted me as a masters student at the Purple Mountain Observatory (PMO), at which point I started my astronomical life.

My first project was to study the line emission of carbon monoxide towards a Galactic supernova remnant, IC 443, which is interacting with ambient molecular clouds. The energetic blast wave from the massive star exploded a few thousand years ago, brutally tearing up the interstellar medium (ISM), dissociating molecules, ionising atoms, and returning newly processed elements to the gas. It is only a tiny part of the baryon cycle in the evolutionary history of our host galaxy, the Milky Way. Actually, I did not know much about what I was doing until I arrived at the PMO 14-metre telescope in Delingha on the 3200-metre high Qinghai-Tibet plateau. My first observations blew my mind. Operating a large telescope, pointing it to science targets, collecting photons, and being the first to see a small “secret” of the Universe, is a non-stop exciting feeling.

Which gases form stars? This is the key question that my PhD project addressed. Only when the molecular gas is dense enough can the gas collapse by gravity and initiate the formation of stars. But what is the density range, and what kind of initial physical conditions matter for the molecular gas? To answer these questions, I went to the Max Planck Institute for Radio astronomy (MPIfR) in Bonn, Germany, as a visiting student working with Christian Henkel and Karl Menten for two years. At the MPIfR, I had opportunities to observe with the Atacama Pathfinder EXperiment (APEX 12-metre) telescope several times; this is my favourite single-dish sub-millimetre facility — both for its world-leading performance and for the family feel. Onsite observing at the 5000-metre high Atacama plateau, where it is extremely dry and lacks oxygen, has been my most exciting adventure.

After my PhD, I moved to Edinburgh to continue research as a postdoc, working closely with Rob Ivison. There, I started to work on galaxies in the early Universe, especially on their ISM properties, including ionised gas, molecular gas and dust. We realised that the afterglow of the Big Bang, the so-called cosmic microwave background (CMB), can seriously frustrate our efforts to image the cold hydrogen gas molecules and cosmic dust found in galaxies in the distant Universe. As the CMB background becomes

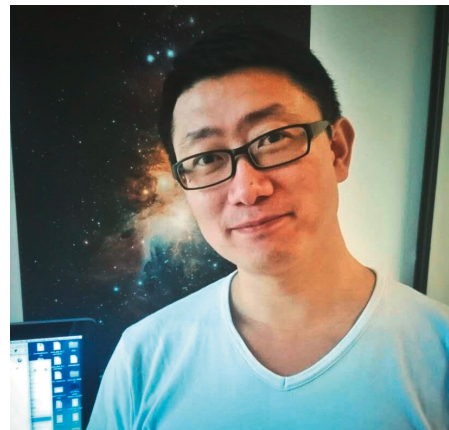

Zhi-Yu Zhang

warmer and warmer in the distant Universe, its temperature becomes almost equal to that of the cold, optically-dark ISM in galaxies. This effect makes that ISM nearly invisible against the rising glow of a warmer CMB, and thus it becomes very hard to detect molecular gas where new stars will form in distant galaxies. It would be like trying to see a swan in the snow, or the shrinking of an ocean island in a rising tide.

After I moved to ESO Garching as an external fellow, my science interests extended to elementary abundances in galaxies and their evolution across cosmic time, especially the isotopes of CNO elements, which in principle could be measured in the ISM. We selected C^{13} and O^{18} isotopes as the target because C^{13} is mostly synthesised by low- and intermediate-mass stars, while the O^{18} production is dominated by massive stars. We performed simultaneous observations of ^{13}CO and $C^{18}O$ emission lines using the Atacama Large Millimeter/submillimeter Array (ALMA), towards a sample of dusty starburst galaxies at $z \sim 2-3$, less than 3 Gyr after the Big Bang. Our new measurements, combined with $^{13}CO/C^{18}O$ ratios found in other types of galaxies, show a systematically decreasing trend from galaxies with low-level star-formation to dusty starburst galaxies — indicating that more massive stars are needed to supply the O^{18} overabundance in starburst galaxies.

Working at ESO Garching is a unique experience for me. There are so many ongoing interesting scientific activities

every week, for example: Gas Matters, Informal Discussions, Knowledge Exchange Series, Wine & Cheese, AGN Club, Journal Club, etc., not to mention the other regular seminars and workshops on the campus. I appreciate the chance to see so many different fields converge and overlap, and to learn something new every day. At ESO, all fellows

are fully independent and great minds do meet together, as a result of which I enjoy collaborating with ESO fellows and staff. I learned from the ESO community that, no matter how crazy your idea is, give it a good try and you will always be pleasantly surprised by new discoveries, new physics, and challenges to classical knowledge with critical thinking.

Acknowledgements

I would like to acknowledge the support received from the University of Edinburgh through the European Research Commission Advanced Grant COSMICISM, 321302 (Principal Investigator: Rob Ivison).

Personnel Movements

Arrivals (1 January–31 March 2019)

Europe

| | |
|---------------------------|-------------------|
| Caillier, Patrick (FR) | Project Manager |
| Fiorellino, Eleonora (IT) | Student |
| Wassill, Sebastian, (DE) | Logistics Officer |

Chile

| | |
|-----------------------------|--------------------------|
| Azcarate, Camilo (CO) | Ombuds |
| Blanco Lopez, Leonardo (FR) | Instrumentation Engineer |
| Moulane, Youssef (MA) | Student |
| van Holstein, Rob (NL) | Student |
| Vasquez, Paulina (CL) | Safety Engineer |

Departures (1 January–31 March 2019)

Europe

| | |
|---------------------------------------|-----------------------------|
| Aros Pinochet, Francisco Ignacio (CL) | Student |
| Brucalassi, Anna (IT) | Astronomer |
| De Cia, Annalisa (IT) | Fellow |
| Escate Giribaldi, Riano (PE) | Student |
| Flörs, Andreas (DE) | Student |
| Guha, Rebonto (DE) | Senior Clerk |
| Jethwa, Prashin (UK) | Fellow |
| Kravchenko, Kateryna (UA) | Student |
| Lucchesi, Romain (FR) | Student |
| Patig, Markus (DE) | Deputy Director for Science |
| Prole, Daniel (UK) | Student |
| van de Ven, Glenn (NL) | Astronomer |
| Watkins, Laura (UK) | Fellow |

Chile

| | |
|------------------------------------|-----------------------------------|
| Aguilar, Max (CL) | Hospitality Operations Supervisor |
| Carcamo, Carolina (CL) | Procurement Officer |
| Gonzalez, Leonardo (CL) | Mechanical Technician |
| Mejia-Restrepo, Julian (CO) | Fellow |
| Sánchez Sáez, Paula (CL) | Student |
| Santamaría Miranda, Alejandro (ES) | Student |



Annual Index 2018 (Nos. 171–174)

Subject Index

Telescopes and Instrumentation

- 40+ Years of Instrumentation for the La Silla Paranal Observatory; D'Odorico, S.; 171, 2
- End-to-End Operations in the ELT Era; Hainaut, O. R.; Bierwirth, T.; Brillant, S.; Mieske, S.; Patat, F.; Rejkuba, M.; Romaniello, M.; Sterzik, M.; 171, 8
- The VLTI Roadmap; Mérand, A.; 171, 14
- The ELT in 2017: The Year of the Primary Mirror; Cerasuolo, M.; Tamai, R.; Cayrel, M.; Koehler, B.; Biancat Marchet, F.; González, J. C.; Dimmler, M.; Tuti, M.; & the ELT team; 171, 20
- Enhanced Data Discovery Services for the ESO Science Archive; Romaniello, M.; Zampieri, S.; Delmotte, N.; Forchi, V.; Hainaut, O. R.; Micol, A.; Retzlaff, J.; Vera, I.; Fourniol, N.; Khan, M. A.; Lange, U.; Sisodia, D.; Stellert, M.; Stoehr, F.; Arnaboldi, M.; Spiniello, C.; Mascetti, L.; Sterzik, M. F.; 172, 2
- HAWK-I/GRAAL Science Verification; Leibundgut, B.; Hiben, P.; Kuntschner, H.; Opitom, C.; Paufigue, J.; Petr-Gotzens, M.; Siebenmorgen, R.; Valenti, E.; Zanella, A.; 172, 8
- Should I stay, or should I go? Service and Visitor Mode at ESO's Paranal Observatory; Rejkuba, M.; Tacconi-Garman, L. E.; Mieske, S.; Anderson, J.; Gadotti, D.; Marteau, S.; Patat, F.; 173, 2
- The Time Allocation Working Group Report; Patat, F.; 173, 7
- The SPECULOOS Southern Observatory Begins its Hunt for Rocky Planets; Jehin, E.; Gillon, M.; Queloz, D.; Delrez, L.; Burdanov, A.; Murray, C.; Sohy, S.; Ducrot, E.; Sebastian, D.; Thompson, S.; McCormac, J.; Almléaky, Y.; Burgasser, A. J.; Demory, B.-O.; de Wit, J.; Barkaoui, K.; Pozuelos, F. J.; Triaud, A. H. M. J.; Grootel, V. V.; 174, 2
- The Life and Times of AMBER: The VLTI's Astronomical Multi-BEam combineR; de Wit, W.-J.; Wittkowski, M.; Rantakyö, F.; Schöller, M.; Mérand, A.; Petrov, R. G.; Weigelt, G.; Malbet, F.; Massi, F.; Kraus, S.; Ohnaka, K.; Millour, F.; Lagarde, S.; Haubois, X.; Bourget, P.; Percheron, I.; Berger, J.-P.; Richichi, A.; 174, 8
- Modelling Data in CASA; Möller, T.; Schilke, P.; Hogerheijde, M.; Stewart, I.; Schaaf, R.; Harsono, D.; 174, 14

Astronomical Science

- Exploring the Sun with ALMA; Bastian, T. S.; Bárta, M.; Brajša, R.; Chen, B.; Pontieu, B. D.; Gary, D. E.; Fleishman, G. D.; Hales, A. S.; Iwai, K.; Hudson, H.; Kim, S.; Kobelski, A.; Loukitcheva, S.; Shimojo, M.; Skokić, I.; Wedemeyer, S.; White, S. M.; Yan, Y.; 171, 25
- The ESO Diffuse Interstellar Band Large Exploration Survey (EDIBLES); Cami, J.; Cox, N. L.; Farhang, A.; Smoker, J.; Elyajouri, M.; Lallement, R.; Bacalla, X.; Bhatt, N. H.; Bron, E.; Cordiner, M. A.; de Koter, A.; Ehrenfreund, P.; Evans, C.; Foing, B. H.; Javadi, A.; Joblin, C.; Kaper, L.; Khosroshahi, H. G.; Laverick, M.; Le Petit, F.; Linnartz, H.; Marshall, C. C.; Monreal-Ibero, A.; Mulas, G.; Roueff, E.; Royer, P.; Salama, F.; Sarre, P. J.; Smith, K. T.; Spaans, M.; van Loon, J. T.; Wade, G.; 171, 31

- APEX Band 9 Reveals Vibrationally Excited Water Sources in Evolved Stars; Baudry, A.; Herpin, F.; Humphreys, E.; Torstensson, K.; Vlemmings, W.; Richards, A.; Gray, M.; De Breuck, C.; Olberg, M.; 171, 37
- ALMA Constrains the Stellar Initial Mass Function of Dusty Starburst Galaxies; Zhang, Z.-Y.; Romano, D.; Ivison, R. J.; Papadopoulos, P. P.; Matteucci, F.; 172, 14
- MIKIS: the ESO-VLT Multi-Instrument Kinematic Survey of Galactic Globular Clusters; Ferraro, F. R.; Mucciarelli, A.; Lanzoni, B.; Pallanca, C.; Origlia, L.; Lapenna, E.; Dalessandro, E.; Valenti, E.; Beccari, G.; Bellazzini, M.; Vesperini, E.; Varrì, A. L.; Sollima, A.; 172, 18
- Constraining Convection in Evolved Stars with the VLTI; Paladini, C.; Baron, F.; Jorissen, A.; Le Bouquin, J.-B.; Freytag, B.; Van Eck, S.; Wittkowski, M.; Hron, J.; Chiavassa, A.; Berger, J.-P.; Siopis, C.; Mayer, A.; Sadowski, G.; Kravchenko, K.; Shetye, S.; Kerschbaum, F.; Kluska, J.; Ramstedt, S.; 172, 24
- A Planet with a Disc? A Surprising Detection in Polarised Light with VLT/SPHERE; Ginski, C.; van Holstein, R.; Juhász, A.; Benisty, M.; Schmidt, T.; Chauvin, G.; de Boer, J.; Wilby, M.; Manara, C. F.; Delorme, P.; Ménard, F.; Muro-Arena, G.; Pinilla, P.; Birnstiel, T.; Flock, M.; Keller, C.; Kenworthy, M.; Milli, J.; Olofsson, J.; Pérez, L.; Snik, F.; Vogt, N.; 172, 27
- Rendezvous with 'Oumuamua; Hainaut, O. R.; Meech, K. J.; Micheli, M.; Belton, M. S. J.; 173, 13
- The Accretion Discs in α with OmegaCAM (ADHOC) Survey; Beccari, G.; Petr-Gotzens, M. G.; Boffin, H. M. J.; Jerabkova, T.; Romaniello, M.; Areal, M. B.; Carraro, G.; Celis, M.; De Marchi, G. D.; de Wit, W.-J.; Drew, J. E.; Fedele, D.; Ferrero, L. V.; Kalari, V. M.; Manara, C. F.; Mardones, D.; Martin, E. L.; Meza, E.; Mieske, S.; Panagia, N.; Testi, L.; Vink, J. S.; Walsh, J. R.; Wright, N. J.; 173, 17
- Life at the Extremes — Massive Star Formation and Evolution in the Galactic Centre; Clark, S.; Lohr, M.; Najarro, F.; Patrick, L.; Evans, C.; Dong, H.; Figer, D.; Lennon, D.; Crowther, P.; 173, 22
- Investigating the Formation and Evolution of Massive Disc Galaxies with the MUSE TIMER Project; Gadotti, D. A.; Sánchez-Blázquez, P.; Falcón-Barroso, J.; Husemann, B.; Seidel, M.; Leaman, R.; Leung, G.; van de Ven, G.; Querejeta, M.; Fragkoudi, F.; de Lorenzo-Cáceres, A.; Méndez-Abreu, J.; Pérez, I.; Kim, T.; Martínez-Valpuesta, I.; Coelho, P.; Donohoe-Keyes, C.; Martig, M.; Neumann, J.; 173, 28
- Resolving the Interstellar Medium at the Peak of Cosmic Star Formation; Calistro Rivera, G.; Hodge, J.; 173, 33
- ALMA Observations of the Epoch of Planet Formation; Andrews, S. M.; Huang, J.; Pérez, L. M.; Isella, A.; Dullemond, C. P.; Kurtovic, N. T.; Guzmán, V. V.; Carpenter, J. M.; Wilner, D. J.; Zhang, S.; Zhu, Z.; Birnstiel, T.; Bai, X.-N.; Benisty, M.; Hughes, A. M.; Öberg, K. I.; Ricci, L.; 174, 19
- A First Spectroscopic Census of the Dwarf Galaxy Leo P; Evans, C.; Castro, N.; Gonzalez, O.; García, M.; Bastian, N.; Cioni, M.-R.; Clark, S.; Davies, B.; Ferguson, A.; Kamann, S.; Lennon, D.; Patrick, L.; Vink, J. S.; Weisz, D.; 174, 24

- Witnessing the Early Growth and Life Cycle of Galaxies with KMOS^{3D}; Förster Schreiber, N. M.; Wilman, D.; Wisnioski, E. S.; Fossati, M.; Mendel, J. T.; Bender, R.; Genzel, R.; Beifiori, A.; Belli, S.; Brammer, G.; Burkert, A.; Chan, J.; Davies, R. I.; Davies, R. L.; Fabricius, M.; Galametz, A.; Herrera-Camus, R.; Lang, P.; Lutz, D.; Momcheva, I.; Naab, T.; Nelson, E. J.; Price, S. H.; Renzini, A.; Saglia, R.; Seitz, S.; Shimizu, T.; Sternberg, A.; Tacconi, L. J.; Tadaki, K.-i.; Übler, H.; van Dokkum, P. G.; Wuyts, S.; 174, 28
- Shedding Light on the Geometry of Kilonovae; Bulla, M.; Covino, S.; Patat, F.; Kyutoku, K.; Maund, J. R.; Tanaka, M.; Toma, K.; Wiersema, K.; D'Avanzo, P.; Higgins, A. B.; Mundell, C. G.; Palazzi, E.; 174, 34

Astronomical News

- New President of Council; Benz, W.; 171, 43
- Review of the Last Three Years at ESO; Roche, P.; 171, 44
- Report on the ESO Workshop "QUESO: Submillimetre/Millimetre/Centimetre Q & U (and V)"; Andreani, P.; Laing, R.; Lu, H.-Y.; 171, 46
- Report on the MOSAIC Science Colloquium "Spectroscopic Surveys with the ELT: A Gigantic Step into the Deep Universe"; Evans, C.; Puech, M.; Hammer, F.; Gallego, J.; Sánchez, A.; García, L.; Iglesias, J.; 171, 47
- Fellows at ESO; Kakkad, D.; Bartlett, E.; Lu, H.-Y.; 171, 49
- Personnel Movements; ESO; 171, 52
- Report on the ESO Workshop "Planning ESO Observations of Future Gravitational Wave Events"; Leibundgut, B.; Patat, F.; 172, 33
- Report on the ESO Workshop "Imaging of Stellar Surfaces"; Wittkowski, M.; Humphreys, L.; 172, 35
- Report on the Workshop "Dispersing Elements for Astronomy: New Trends and Possibilities"; Bianco, A.; Bernstein, R.; de Ugarte Postigo, A.; Garzon, F.; Holland, W.; Manescau, A.; Navarro, R.; Riva, M.; 172, 40
- Report on the ESO-Radionet Workshop "Submillimetre Single-dish Data Reduction and Array Combination Techniques"; De Breuck, C.; Teuben, P.; Stanke, T.; 172, 42
- Report on the ESO Workshop "La Silla Paranal Users Workshop"; Boffin, H. M. J.; Rejkuba, M.; 172, 44
- Report on the ESO-NEON Observing School at La Silla Observatory; Selman, F.; Melo, C.; Beccari, G.; Boffin, H. M. J.; Ivanov, V.; Sani, E.; Schmidtobreick, L.; Dennefeld, M.; Korhonen, H.; 172, 46
- Fellows at ESO; Opitom, C.; Harrison, C.; Querejeta, M.; 172, 50
- Raymond Wilson, 1928–2018; Cullum, M.; 172, 53
- Personnel Movements; ESO; 172, 55
- The ESO Digital Object Identifier Service; Bordelon, D.; Grothkopf, U.; Meakins, S.; 173, 38
- Report on the ESO Workshop "Diversis mundi: The Solar System in an Exoplanetary context (OPS-III)"; Lillo-Box, J.; Opitom, C.; 173, 40
- Report on the ESO Workshop "Proposal Submission Tools"; Biggs, A.; Bridger, A.; Carpenter, J.; De Breuck, C.; Glendenning, B.; Iono, D.; Schmid, E.; Testi, L.; 173, 44

- Report on the ESO–INAF Workshop “VST in the Era of the Large Sky Surveys”; Schipani, P.; Arnaboldi, M.; Iodice, E.; Leibundgut, B.; 173, 46
- Report on the ESO–European Interferometry Initiative School “The 9th Very Large Telescope Interferometer School”; Garcia, P. J. V.; Filho, M.; Amorim, A.; Mérand, A.; 173, 49
- The First ESO Astronomy Research Training — Ghana 2018; Arrigoni-Battaia, F.; Löbbling, L.; Man, A.; Asabere, B. D.; Kerzendorf, W.; Valenti, E.; 173, 51
- Fellows at ESO; Dias, B.; Zanella, A.; van der Burg, R.; 173, 54
- Leon B. Lucy, 1938–2018; Baade, D.; Danziger, J.; Hook, R.; Walsh, J. R.; 173, 58
- Personnel Movements; ESO; 173, 59
- ESO Conference Proceedings 2.0 at Zenodo; Meakins, S.; Gómez, M. E.; Bordelon, D.; Grothkopf, U.; 174, 38
- Report on the ESO Workshop “A Revolution in Stellar Physics with Gaia and Large Surveys”; Smiljanic, R.; Hussain, G.; Pasquini, L.; 174, 40
- Report on the ESO Workshop “Take a Closer Look: The Innermost Region of Protoplanetary Discs and its Connection to the Origin of Planets”; Manara, C. F.; Schneider, P. C.; Hussain, G.; Facchini, S.; Miotello, A.; 174, 44
- Fellows at ESO; Chen, C.-C.; Gallenne, A.; Wylezalek, D.; 174, 48
- Riccardo Giacconi (1931–2018); Barcons, X.; Spyromilio, J.; 174, 53
- Personnel Movements; ESO; 174, 55

Author Index

A

- Andreani, P.; Laing, R.; Lu, H.-Y.; Report on the ESO Workshop “QUESO: Submillimetre/Millimetre/Centimetre Q & U (and V)”; 171, 46
- Andrews, S. M.; Huang, J.; Pérez, L. M.; Isella, A.; Dullemond, C. P.; Kurtović, N. T.; Guzmán, V. V.; Carpenter, J. M.; Wilner, D. J.; Zhang, S.; Zhu, Z.; Birnstiel, T.; Bai, X.-N.; Benisty, M.; Hughes, A. M.; Öberg, K. I.; Ricci, L.; ALMA Observations of the Epoch of Planet Formation; 174, 19
- Arrigoni-Battaia, F.; Löbbling, L.; Man, A.; Asabere, B. D.; Kerzendorf, W.; Valenti, E.; The First ESO Astronomy Research Training — Ghana 2018; 173, 51

B

- Baade, D.; Danziger, J.; Hook, R.; Walsh, J. R.; Leon B. Lucy, 1938–2018; 173, 58
- Barcons, X.; Spyromilio, J.; Riccardo Giacconi (1931–2018); 174, 53
- Bastian, T. S.; Bárta, M.; Brajša, R.; Chen, B.; Pontieu, B. D.; Gary, D. E.; Fleishman, G. D.; Hales, A. S.; Iwai, K.; Hudson, H.; Kim, S.; Kobelski, A.; Loukitcheva, M.; Shimojo, M.; Skokić, I.; Wedemeyer, S.; White, S. M.; Yan, Y.; Exploring the Sun with ALMA; 171, 25
- Baudry, A.; Herpin, F.; Humphreys, E.; Torstensson, K.; Vlemmings, W.; Richards, A.; Gray, M.; De Breuck, C.; Olberg, M.; APEX Band 9 Reveals Vibrationally Excited Water Sources in Evolved Stars; 171, 37
- Beccari, G.; Petr-Gotzens, M. G.; Boffin, H. M. J.; Jerabkova, T.; Romaniello, M.; Areal, M. B.; Carraro, G.; Celis, M.; De Marchi, G. D.; de Wit, W.-J.; Drew, J. E.; Fedele, D.; Ferrero, L. V.; Kalari, V. M.; Manara, C. F.; Mardones, D.; Martin, E. L.; Meza, E.; Mieske, S.; Panagia, N.; Testi, L.; Vink, J. S.; Walsh, J. R.; Wright, N. J.; The Accretion Discs in H α with OmegaCAM (ADHOC) Survey; 173, 17
- Benz, W.; New President of Council; 171, 43

- Bianco, A.; Bernstein, R.; de Ugarte Postigo, A.; Garzon, F.; Holland, W.; Manescau, A.; Navarro, R.; Riva, M.; Report on the Workshop “Dispersing Elements for Astronomy: New Trends and Possibilities”; 172, 40
- Biggs, A.; Bridger, A.; Carpenter, J.; De Breuck, C.; Glendenning, B.; Iono, D.; Schmid, E.; Testi, L.; Report on the ESO Workshop “Proposal Submission Tools”; 173, 44
- Boffin, H. M. J.; Rejkuba, M.; Report on the ESO Workshop “La Silla Paranal Users Workshop”; 172, 44
- Bordelon, D.; Grothkopf, U.; Meakins, S.; The ESO Digital Object Identifier Service; 173, 38
- Bulla, M.; Covino, S.; Patat, F.; Kyutoku, K.; Maund, J. R.; Tanaka, M.; Toma, K.; Wiersema, K.; D’Avanzo, P.; Higgins, A. B.; Mundell, C. G.; Palazzi, E.; Shedding Light on the Geometry of Kilonovae; 174, 34

C

- Calistro Rivera, G.; Hodge, J.; Resolving the Interstellar Medium at the Peak of Cosmic Star Formation; 173, 33
- Cami, J.; Cox, N. L.; Farhang, A.; Smoker, J.; Elyajouri, M.; Lallement, R.; Bacalla, X.; Bhatt, N. H.; Bron, E.; Cordiner, M. A.; de Koter, A.; Ehrenfreund, P.; Evans, C.; Foing, B. H.; Javadi, A.; Joblin, C.; Kaper, L.; Khosroshahi, H. G.; Laverick, M.; Le Petit, F.; Linnartz, H.; Marshall, C. C.; Monreal-Ibero, A.; Mulas, G.; Roueff, E.; Royer, P.; Salama, F.; Sarre, P. J.; Smith, K. T.; Spaans, M.; van Loon, J. T.; Wade, G.; The ESO Diffuse Interstellar Band Large Exploration Survey (EDIBLES); 171, 31
- Chen, C.-C.; Gallenne, A.; Wylezalek, D.; Fellows at ESO; 174, 48
- Cirasuolo, M.; Tamai, R.; Cayrel, M.; Koehler, B.; Biancat Marchet, F.; González, J. C.; Dimmler, M.; Tuti, M.; & the ELT team; The ELT in 2017: The Year of the Primary Mirror; 171, 20
- Clark, S.; Lohr, M.; Najarro, F.; Patrick, L.; Evans, C.; Dong, H.; Figer, D.; Lennon, D.; Crowther, P.; Life at the Extremes — Massive Star Formation and Evolution in the Galactic Centre; 173, 22
- Cullum, M.; Raymond Wilson, 1928–2018; 172, 53

D

- D’Odorico, S.; 40+ Years of Instrumentation for the La Silla Paranal Observatory; 171, 2
- De Breuck, C.; Teuben, P.; Stanke, T.; Report on the ESO–Rationet Workshop “Submillimetre Single-dish Data Reduction and Array Combination Techniques”; 172, 42
- de Wit, W.-J.; Wittkowski, M.; Rantakyö, F.; Schöller, M.; Mérand, A.; Petrov, R. G.; Weigelt, G.; Malbet, F.; Massi, F.; Kraus, S.; Ohnaka, K.; Millour, F.; Lagarde, S.; Haubois, X.; Bourget, P.; Percheron, I.; Berger, J.-P.; Richichi, A.; The Life and Times of AMBER: The VLTI’s Astronomical Multi-BEam combineR; 174, 8
- Dias, B.; Zanella, A.; van der Burg, R.; Fellows at ESO; 173, 54

E

- Evans, C.; Puech, M.; Hammer, F.; Gallego, J.; Sánchez, A.; García, L.; Iglesias, J.; Report on the MOSAIC Science Colloquium “Spectroscopic Surveys with the ELT: A Gigantic Step into the Deep Universe”; 171, 47
- Evans, C.; Castro, N.; Gonzalez, O.; Garcia, M.; Bastian, N.; Cioni, M.-R.; Clark, S.; Davies, B.; Ferguson, A.; Kamann, S.; Lennon, D.; Patrick, L.; Vink, J. S.; Weisz, D.; A First Spectroscopic Census of the Dwarf Galaxy Leo P; 174, 24

F

- Ferraro, F. R.; Mucciarelli, A.; Lanzoni, B.; Pallanca, C.; Origlia, L.; Lapenna, E.; Dalessandro, E.; Valenti, E.; Beccari, G.; Bellazzini, M.; Vesperini, E.; Varri, A. L.; Sollima, A.; MikiS: the ESO-VLT Multi-Instrument Kinematic Survey of Galactic Globular Clusters; 172, 18

Förster Schreiber, N. M.; Wilman, D.; Wisnioski, E. S.; Fossati, M.; Mendel, J. T.; Bender, R.; Genzel, R.; Beifiori, A.; Belli, S.; Brammer, G.; Burkert, A.; Chan, J.; Davies, R. I.; Davies, R. L.; Fabricius, M.; Galametz, A.; Herrera-Camus, R.; Lang, P.; Lutz, D.; Momcheva, I.; Naab, T.; Nelson, E. J.; Price, S. H.; Renzini, A.; Saglia, R.; Seitz, S.; Shimizu, T.; Sternberg, A.; Tacconi, L. J.; Tadaki, K.-i.; Übler, H.; van Dokkum, P. G.; Wuyts, S.; Witnessing the Early Growth and Life Cycle of Galaxies with KMOS3D; 174, 28

G

Gadotti, D. A.; Sánchez-Blázquez, P.; Falcón-Barroso, J.; Husemann, B.; Seidel, M.; Leaman, R.; Leung, G.; van de Ven, G.; Querejeta, M.; Fragkoudi, F.; de Lorenzo-Cáceres, A.; Méndez-Abreu, J.; Pérez, I.; Kim, T.; Martínez-Valpuesta, I.; Coelho, P.; Donohoe-Keyes, C.; Martig, M.; Neumann, J.; Investigating the Formation and Evolution of Massive Disc Galaxies with the MUSE TIMER Project; 173, 28

García, P. J. V.; Filho, M.; Amorim, A.; Mérand, A.; Report on the ESO–European Interferometry Initiative School “The 9th Very Large Telescope Interferometer School”; 173, 49

Ginski, C.; van Holstein, R.; Juhász, A.; Benisty, M.; Schmidt, T.; Chauvin, G.; de Boer, J.; Wilby, M.; Manara, C. F.; Delorme, P.; Ménard, F.; Muro-Arena, G.; Pinilla, P.; Birnstiel, T.; Flock, M.; Keller, C.; Kenworthy, M.; Milli, J.; Olofsson, J.; Pérez, L.; Snik, F.; Vogt, N.; A Planet with a Disc? A Surprising Detection in Polarised Light with VLT/SPHERE; 172, 27

H

Hainaut, O. R.; Bierwirth, T.; Brillant, S.; Mieske, S.; Patat, F.; Rejkuba, M.; Romaniello, M.; Sterzik, M.; End-to-End Operations in the ELT Era; 171, 8

Hainaut, O. R.; Meech, K. J.; Micheli, M.; Belton, M. S. J.; Rendezvous with ‘Oumuamua; 173, 13

J

Jehin, E.; Gillon, M.; Queloz, D.; Delrez, L.; Burdanov, A.; Murray, C.; Sohy, S.; Ducrot, E.; Sebastian, D.; Thompson, S.; McCormac, J.; Almlaky, Y.; Burgasser, A. J.; Demory, B.-O.; de Wit, J.; Barkaoui, K.; Pozuelos, F. J.; Triaud, A. H. M. J.; Grootel, V. V.; The SPECULOOS Southern Observatory Begins its Hunt for Rocky Planets; 174, 2

K

Kakkad, D.; Bartlett, E.; Lu, H.-Y.; Fellows at ESO; 171, 49

L

Leibundgut, B.; Hiben, P.; Kuntschner, H.; Opatom, C.; Pauflique, J.; Petr-Gotzens, M.; Siebenmorgen, R.; Valenti, E.; Zanella, A.; HAWK-I/GRAAL Science Verification; 172, 8

Leibundgut, B.; Patat, F.; Report on the ESO Workshop “Planning ESO Observations of Future Gravitational Wave Events”; 172, 33

Lillo-Box, J.; Opatom, C.; Report on the ESO Workshop “*Diversis mundi*: The Solar System in an Exoplanetary context (OPS-III)”; 173, 40

M

Manara, C. F.; Schneider, P. C.; Hussain, G.; Facchini, S.; Miotello, A.; Report on the ESO Workshop “Take a Closer Look: The Innermost Region of Protoplanetary Discs and its Connection to the Origin of Planets”; 174, 44

Meakins, S.; Gómez, M. E.; Bordelon, D.; Grothkopf, U.; ESO Conference Proceedings 2.0 at Zenodo; 174, 38

Mérand, A.; The VLT Roadmap; 171, 14

Möller, T.; Schilke, P.; Hogerheijde, M.; Stewart, I.; Schaaf, R.; Harsono, D.; Modelling Data in CASA; 174, 14

O

Opatom, C.; Harrison, C.; Querejeta, M.; Fellows at ESO; 172, 50

P

Paladini, C.; Baron, F.; Jorissen, A.; Le Bouquin, J.-B.; Freytag, B.; Van Eck, S.; Wittkowski, M.; Hron, J.; Chiavassa, A.; Berger, J.-P.; Siopis, C.; Mayer, A.; Sadowski, G.; Kravchenko, K.; Shetye, S.; Kerschbaum, F.; Kluska, J.; Ramstedt, S.; Constraining Convection in Evolved Stars with the VLT; 172, 24

Patat, F.; The Time Allocation Working Group Report; 173, 7

R

Rejkuba, M.; Tacconi-Garman, L. E.; Mieske, S.; Anderson, J.; Gadotti, D.; Marteau, S.; Patat, F.; Should I stay, or should I go? Service and Visitor Mode at ESO’s Paranal Observatory; 173, 2

Roche, P.; Review of the Last Three Years at ESO; 171, 44

Romaniello, M.; Zampieri, S.; Delmotte, N.; Forchì, V.; Hainaut, O. R.; Micol, A.; Retzlaff, J.; Vera, I.; Fourniol, N.; Khan, M. A.; Lange, U.; Sisodia, D.; Stellert, M.; Stoehr, F.; Arnaboldi, M.; Spiniello, C.; Mascetti, L.; Sterzik, M. F.; Enhanced Data Discovery Services for the ESO Science Archive; 172, 2

S

Schipani, P.; Arnaboldi, M.; Iodice, E.; Leibundgut, B.; Report on the ESO–INAF Workshop “VST in the Era of the Large Sky Surveys”; 173, 46

Selman, F.; Melo, C.; Beccari, G.; Boffin, H. M. J.; Ivanov, V.; Sani, E.; Schmidtbreick, L.; Dennefeld, M.; Korhonen, H.; Report on the ESO–NEON Observing School at La Silla Observatory; 172, 46

Smiljanic, R.; Hussain, G.; Pasquini, L.; Report on the ESO Workshop “A Revolution in Stellar Physics with Gaia and Large Surveys”; 174, 40

W

Wittkowski, M.; Humphreys, L.; Report on the ESO Workshop “Imaging of Stellar Surfaces”; 172, 35

Z

Zhang, Z.-Y.; Romano, D.; Ivison, R. J.; Papadopoulos, P. P.; Matteucci, F.; ALMA Constrains the Stellar Initial Mass Function of Dusty Starburst Galaxies; 172, 14



Road to the stars

A unique opportunity to conduct part of
your PhD research at the
European Southern Observatory

#ESOJOBS
eso.org/studentship

ESO Headquarters, Garching near Munich, Germany
ESO Vitacura, Santiago, Chile

Application deadline: 31 May and 15 November, each year