



EUROPEAN SOUTHERN OBSERVATORY

Organisation Européenne pour des Recherches Astronomiques dans l'Hémisphère Austral
Europäische Organisation für astronomische Forschung in der südlichen Hemisphäre

ESO - European Southern Observatory
Karl-Schwarzschild Str. 2, D-85748 Garching bei München

Very Large Telescope Paranal Science Operations VISIR User Manual

Doc. No. VLT-MAN-ESO-14300-3514

Issue 90, Date 26/02/2012

Y. Momany
Prepared

Date Signature

C. Dumas
Approved

Date Signature

A. Kaufer
Released

Date Signature

This page was intentionally left blank

Change Record

Issue/Rev.	Date	Section/Parag. affected	Reason/Initiation/Documents/Remarks
1.0	04/09/04	creation	First release for science verification in P74 and OT proposals in P75.
1.1	10/12/04	2.4, 3.2, 6.2, 6.3, 7, 8	update for P75 Phase2
v76.1	01/02/05	all	update for P76 CfP
v76.2	06/07/05	all	update for P76 Phase 2
v76.3	14/07/05	4.8.1	Corrected Legend Fig 17
v76.4	14/07/05	Cover pages	Corrected typos
v77.1	04/09/05	3.5,3.6,3.7,4.1,4.3,4.8.1,7,8.1,10	update for P77 CfP
v77.2	05/09/05	4.6	match imager overhead of CfP
v77.3	20/12/05	1,2,3.4,3.6,4.2-4.4,4.7,7,8	update for P77 Phase2
v78.1	27/02/06	3.6, 3.10	update for P78 CfP
v78	19/06/06	cover, 2.2, 3.2, 4.3.1	P78 release
v79	30/11/06	4.8	P79 release
v80	28/02/07	3.1, 4.2.1, 5.1, 6.2, 8.2	P80 release, burst mode included
v81	31/08/07	3.1, 4.2.1, 4.3.2	P81 release, new filters included
v87	22/09/10	4.3.2, 8.2, 8.3	P87 release, Exclusion of <i>K</i> -band in science imaging templates
		3.2.5	P87 release, update of HR allowed λ_c First line of Table.7 modified
		8.2	P87 release, non-availability of <i>jitter</i> with <i>IMG – GenericChopNod</i>
v88	22/02/2011	4.1	P88 release, upper limit of 5 filters in a single service mode OB
		4.4	P88 release, UCAC3 substituting USNO for guide stars selections.
v89	31/08/2011	all	P89 release, removing most references to the old DRS detector, and reporting the first properties of the AQUARIUS detector.
v90	26/02/2012	1	Update the new schedule of the VISIR upgrade.
v1.0, v1.1, v76.1: edited by R. Siebenmorgen, E. Pantin, M. Sterzik v76.2–4, v77.1-3, updated by A. Smette. v78 – 80, updated by L. Vanzi. v87 – 90, updated by Y. Momany.			

Contents

1	VISIR Upgrade Project	1
1.1	Detector Upgrade	1
1.2	Low Resolution Spectroscopy	1
1.3	Precipitable Water Vapour	1
2	Introduction	3
3	Observing in the MIR from the ground	3
3.1	The Earth's atmosphere	3
3.2	The spatial resolution	3
3.3	MIR background	4
3.4	Chopping and nodding	4
3.5	Sensitivity	5
4	Instrument description and offered observing modes	8
4.1	Imager	8
4.2	Spectrometer	12
4.2.1	Slit widths	13
4.2.2	Resolution	13
4.2.3	Low resolution: offered central wavelengths	13
4.2.4	Medium resolution: offered central wavelengths	14
4.2.5	High resolution: offered central wavelengths	14
4.3	Calibration units	14
4.4	Detectors	14
4.5	Data acquisition system	16
5	Observing with VISIR at the VLT	17
5.1	Proposal preparation	17
5.2	Telescope observing parameters	19
5.2.1	Instrument orientation on the sky	19
5.2.2	Chopping parameters	19
5.2.3	Nodding parameters	20
5.3	Target acquisition	20
5.3.1	Introduction	20
5.3.2	Description	21
5.4	Guide stars	24
5.5	Brightness limitations	24
5.6	Overheads	25
5.7	Calibration observations	25
5.8	OBs Classification	27
5.9	Known problems	27
6	VISIR data	27
6.1	Data format	27
6.2	Pipeline	27
6.3	VISIR spectrometer data	28

7	VISIR templates description	30
7.1	Acquisition	30
7.2	Observing with the imager	30
7.3	Observing with the spectrometer	32
7.4	Calibration	33
8	Checklist	34
8.1	Phase 1	34
8.2	Phase 2	34
9	Appendix: VISIR template parameters	36
9.1	Observation	39
9.2	Calibration	41
10	Appendix: Filter transmission curves	43
11	Appendix: Observed sensitivities in various spectroscopic settings	46

List of acronyms

BIB	Blocked impurity band
BLIP	Background limited performance
BOB	Broker of observation blocks
DIT	Detector integration time
ETC	Exposure time calculator
FWHM	Full width at half maximum
ICS	Instrument control software
IR	Infrared
IRACE	Infrared array control electronics
MIR	Mid infrared
OB	Observing block
P2PP	Phase 2 proposal preparation
PAE	Preliminary acceptance in Europe
pfov	pixel field of view
PSF	Point spread function
S/N	Signal-to-noise ratio
UT	Unit telescope
VISIR	VLT imager and spectrometer for the mid infrared
TCS	Telescope control system
TMA	Three mirrors anastigmatic
WCU	Warm calibration unit

1 VISIR Upgrade Project

During the period May-August 2012 (P89) VISIR will go through the implementation of its upgrade project. It is expected that VISIR will be offered back to regular service and visitor mode observations the last 2 weeks of September 2012 (Period 89), and for the entire Period 90.

The post-upgrade VISIR performance is expected to be significantly better. However, no details can be provided at the moment. For the time being, we here list the major modifications that VISIR P90 science users will need to plan their proposals. The astronomical community is encouraged to monitor the latest news on the upgrade, reported on:

<http://www.eso.org/sci/facilities/paranal/instruments/visir/upgradeproject.html>.

1.1 Detector Upgrade

The major part of the upgrade project concerns the replacement of the current detector (DRS 256 × 256 pixel array) with The Raytheon AQUARIUS 1024 × 1024 pixel array. This hardware upgrade is expected to significantly improve the VISIR performance in terms of field coverage and sensitivity. Currently, two pixel scales are offered: 0'075 and 0'127, so-called Small-Field and Intermediate-Field (SF and IF) providing a field of view of 19 × 19 and 32 × 32 arcseconds, respectively. The new AQUARIUS detector will be offered in two pixel scales: 0'045 and 0'076, SF and IF respectively. The projected field of view will therefore be 46 × 46 and 78 × 78 arcseconds.

As for Exposure time calculation, the astronomical community is invited to use the well-established DRS detector sensitivities (both for spectroscopy and imaging) as provided in Tables, 2, 3, 6 and 7. Indeed, the new AQUARIUS detector has proven to show better performance, however a final characterization of the achieved sensitivities is to await the commissioning and science verification. The cosmetic quality of the AQUARIUS detector is proven to be excellent. The regions of masked pixels (Fig. 12) and stripes (Fig. 13) are not present anymore.

1.2 Low Resolution Spectroscopy

The second major improvement is that concerning the N-band 8 – 13 μm Low Resolution Spectroscopy. Currently, this is achieved by means of a grism, and has the disadvantage of requiring 4 independent exposures in order to cover the 8 – 13 μm range. The introduction of the low resolution prism ($R \approx 300$ for a 0'3 slit) will allow to achieve the same wavelength coverage in a single exposure and reach improved sensitivities.

1.3 Precipitable Water Vapour

The amount of Precipitable Water Vapour (PWV) present in the Earth's atmosphere can heavily impact on Mid-infrared observations. Operations-wise, a prior knowledge of the PWV content will seriously impact on efficient service and visitor mode VISIR observations. As part of the VISIR upgrade project, and starting December 2011, real-time PWV monitor is now available on Paranal¹. The commissioning of the PWV monitor shows that it meets all specifications:

- PWV range 0.5-9 mm validated
- PWV precision: ca 30 μm

¹http://www.eso.org/tecarch/Documents/VLT/14300-mid_ir_imager_spectrometer/14330-VISIR_Upgrade/SoW_for%20RS_campaign_5504.pdf

- PWV accuracy: ca 0.1 mm
- High time resolution (sec)
- All sky pointing, 2D capability
- Autonomous operation

It is expected that the PWV value will be used as user-defined a constraint parameter starting Period 90 (October 2012- April 2013).

2 Introduction

The VLT xxx spectrometer and imager for the mid-infrared (VISIR), built by CEA/DAPNIA/SAP and NFRA/ASTRON, provides diffraction-limited imaging at high sensitivity in two mid-infrared (MIR) atmospheric windows: the N-band between ≈ 8 to $13 \mu\text{m}$ and the Q-band between 16.5 and $24.5 \mu\text{m}$. In addition, it offers a slit spectrometer with a range of spectral resolutions between 150 and 30000.

The MIR provides invaluable information about the warm dust and gas phase of the Universe. Micron sized particles such as silicates, silicon carbide, carbon, coals, aluminum oxides or polycyclic aromatic hydrocarbon (PAH) molecules are major contributors to the thermal MIR emission. The gaseous phase emits through a large number of ionic and atomic lines. Examples are NeII ($12.8 \mu\text{m}$) and the pure rotation lines of molecular hydrogen at 8.02 , 9.66 , 12.27 and $17.03 \mu\text{m}$.

Because of the very high background from the ambient atmosphere and telescope, the sensitivity of ground-based MIR instruments cannot compete with that of space-born ones. However, ground based instruments mounted on large telescopes offer superior spatial resolution. For example VISIR at the VLT provides diffraction limited images at $\sim 0.3''$ (FWHM) in the N band. This is an order of magnitude better than what can be reached by the Spitzer Space Telescope (SST).

The VISIR user manual is structured as follows: Basic observing techniques of ground-based MIR instruments are summarized in §3. §4 provides a technical description of VISIR and its offered observing modes offered. An overview on how to observe with VISIR at the VLT can be found in § 5. A description of the structure of the imaging and spectroscopic data files is given in § 6. A checklist to help the preparation of OBs is available in § 8. Acquisition, observing and calibration templates are explained in § 7.

We strongly recommend to consult:

<http://www.eso.org/instruments/visir/> for additional information and updates. For support during proposal preparation and OB submission, please contact ESO's User Support Department (usd-help@eso.org).

3 Observing in the MIR from the ground

3.1 The Earth's atmosphere

Our atmosphere absorbs the majority of the MIR radiation from astronomical sources. The main absorbing molecules are H_2O , CH_4 , CO_2 , CO , O_2 , O_3 . However, the atmosphere is quite transparent in two atmospheric windows: the N and Q bands. They are centered around 10 and $20 \mu\text{m}$, respectively. The transmission in the N band is fairly good at a dry site and becomes particularly transparent in the wavelength range 10.5 - $12 \mu\text{m}$. However, the transmission of the Q band is rapidly decreasing with wavelength and can be viewed as the superposition of many sub-bands having a typical spectral coverage of $\Delta\lambda = 1 \mu\text{m}$ at an average transmission of 60%. Observations in this band require low water vapor content in the atmosphere. The atmospheric transmission in the N and Q bands is displayed on Fig. 1.

3.2 The spatial resolution

The spatial resolution of an instrument is ultimately limited either by the diffraction of the telescope or the atmospheric seeing. The diffraction limit as measured by the diameter of the first Airy ring increases with wavelength as $1.22 \lambda/D$, where λ is the observing wavelength and D the diameter

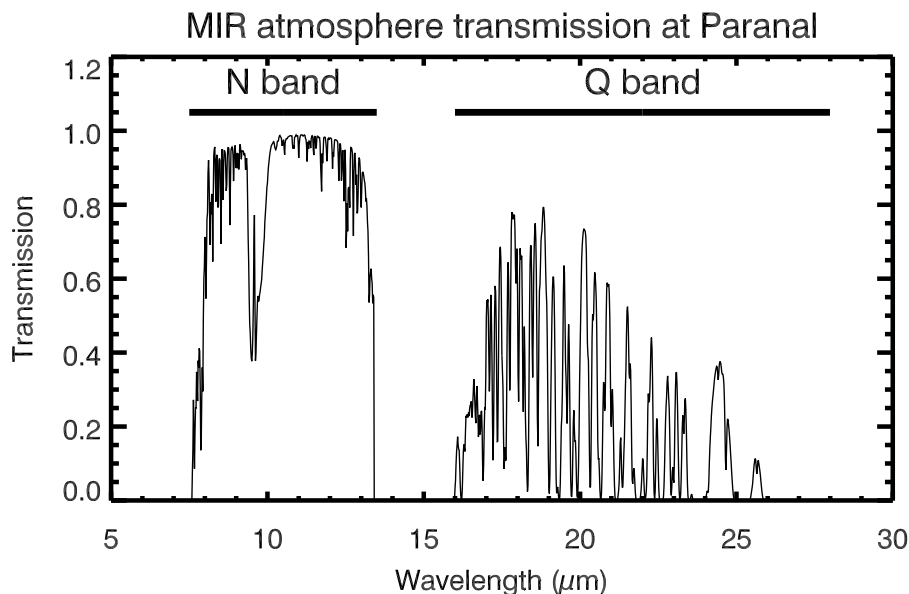

Figure 1: MIR atmospheric transmission at Paranal computed with HITRAN for an altitude of 2600 m and 1.5 mm of precipitable water vapor at zenith. The US standard model atmosphere is used.

of the telescope mirror (see solid line in Fig. 2). The wavelength dependence of the seeing can be derived by studying the spatial coherence radius of the atmosphere in the telescope beam and is to first order approximated by the Roddier formula, where the seeing is $\propto \lambda^{-0.2}$ (see dot-dashed lines in Fig. 2). However, initial results from VISIR data indicate that this formula overestimates the measured MIR seeing at Paranal by 20–50%, as the size of a UT mirror is comparable to the turbulence outer scale. As a result, VISIR data are already diffraction limited for optical seeing below $0.6''$. The results of measures obtained in 2005 are shown in Fig. 3.

3.3 MIR background

The atmosphere does not only absorb MIR photons coming from astrophysical targets, but also emits a strong background with the spectral shape of a black-body at about 253 K (Kirchhoff's law). The telescope gives an additional MIR background. The VLT telescopes emits at 283 K with a preliminary emissivity estimate of $< 15\%$ in N. The VISIR instrument is cooled to avoid internal background contamination. The detectors are at $\sim 5 - 6$ K and the interior of the cryostat at 33 K. The background radiation at $10\mu\text{m}$ is typically $m_N = -5 \text{ mag/arcsec}^2$ (3700 Jy/arcsec^2) and at $20\mu\text{m}$ $m_Q = -7.3 \text{ mag/arcsec}^2$ (8300 Jy/arcsec^2).

Consequently, the number of photons reaching the detector is huge, often more than 10^8 photons/s. Therefore, the exposure time of an individual integration - the Detector Integration Time (DIT) - is short, of the order of a few tens of milli-seconds in imaging mode.

3.4 Chopping and nodding

The basic idea to suppress the MIR background is to perform differential observations, using the chopping/nodding technique.

In the chopping technique two observations are performed. One set of exposures on-source, include the background and the astronomical source. A second set of off-source exposures measures the

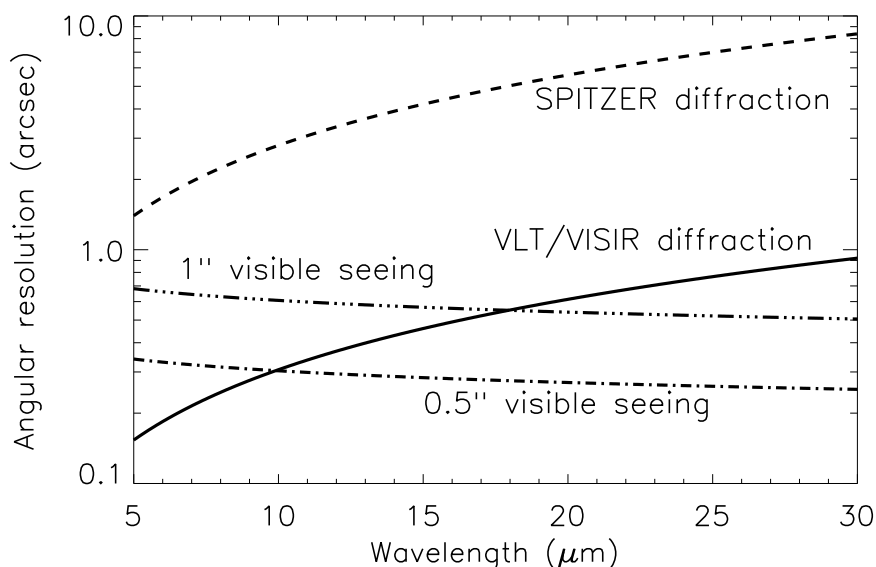

Figure 2: VLT diffraction limit (full line) versus seeing. The Spitzer Space Telescope diffraction limits (dashed) are shown for comparison. The Roddier dependence is shown for two optical seeings (dashed-dot).

pure background. The on- and off-source observations have to be alternated at a rate faster than the rate of the background fluctuations. In practice, it is achieved by moving the secondary mirror of the telescope. For VISIR at Paranal, a chopping frequency of 0.25 Hz has been found to be adequate for N-band imaging observations, while 0.5 Hz are adopted for Q-band imaging. Spectroscopic observations are performed with lower chopper frequencies, at 0.1 Hz or less.

The chopping technique cancels most of the background. However, the optical path is not exactly the same in both chopper positions. Therefore a residual background remains. It is varying at a time-scale which is long compared to that of the sky. This residual is suppressed by nodding, where the telescope itself is moved off-source and the same chopping observations as in the on-source position is repeated.

An illustration of the chopping and nodding technique is shown on Fig. 4. Depending on the choice of chopping and nodding amplitudes and directions, up to 4 images of the source can be seen on the frame and used for scientific analysis. Of course, the *free* field-of-view on the chop/nod images can be severely reduced depending on the particular chopping and nodding parameters chosen.

3.5 Sensitivity

Measurements of VISIR sensitivities are based on observations of mid-infrared calibration standard stars (Cohen et al. 1999, AJ 117, 1864). In imaging mode, the stars are recorded in the small field (0.045'') and intermediate field (0.076'') by perpendicular chopping and nodding patterns with amplitudes of 10''. Calibrators are frequently observed during the night (§5.7). Flux and noise levels are extracted by multi-aperture photometry using the curve-of-growth method: the aperture used for all 4 beams in a given frame is the one for which the flux to noise ratio is the largest. By combining all 4 beams, *the sensitivity in a given set-up (filter, field of view) is defined as the limiting flux of a point-source detected with a S/N of 10 in one hour of on-source integration.*

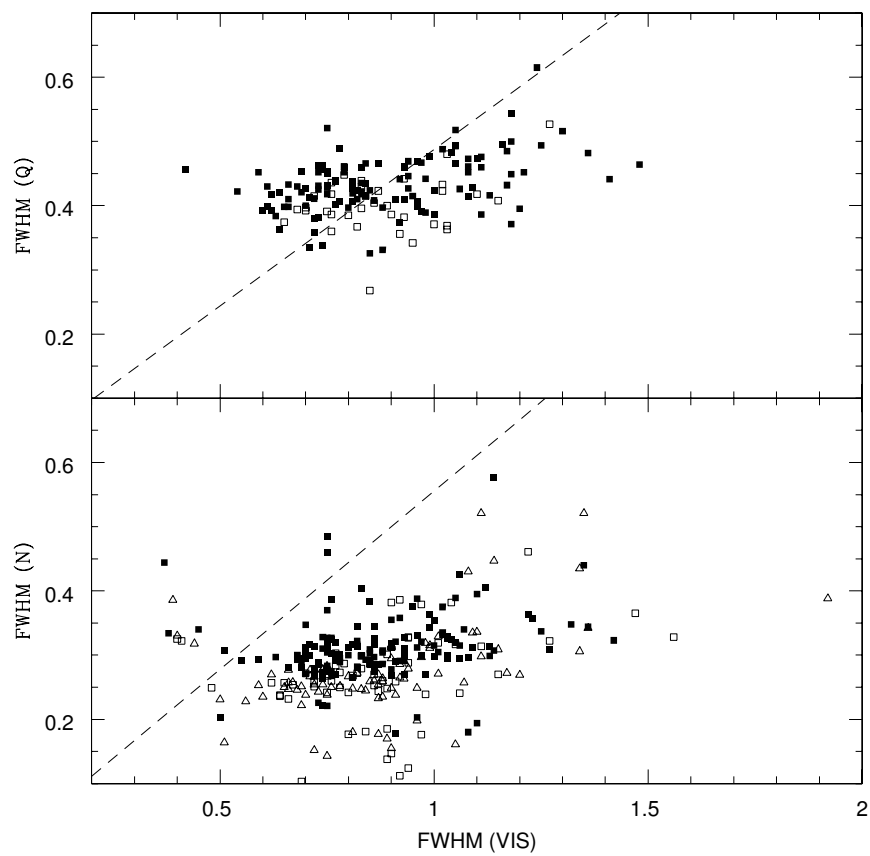

Figure 3: Measures of the VISIR image quality versus optical seeing obtained during 2005. The dashed lines indicates the prediction of Roddier's formula.

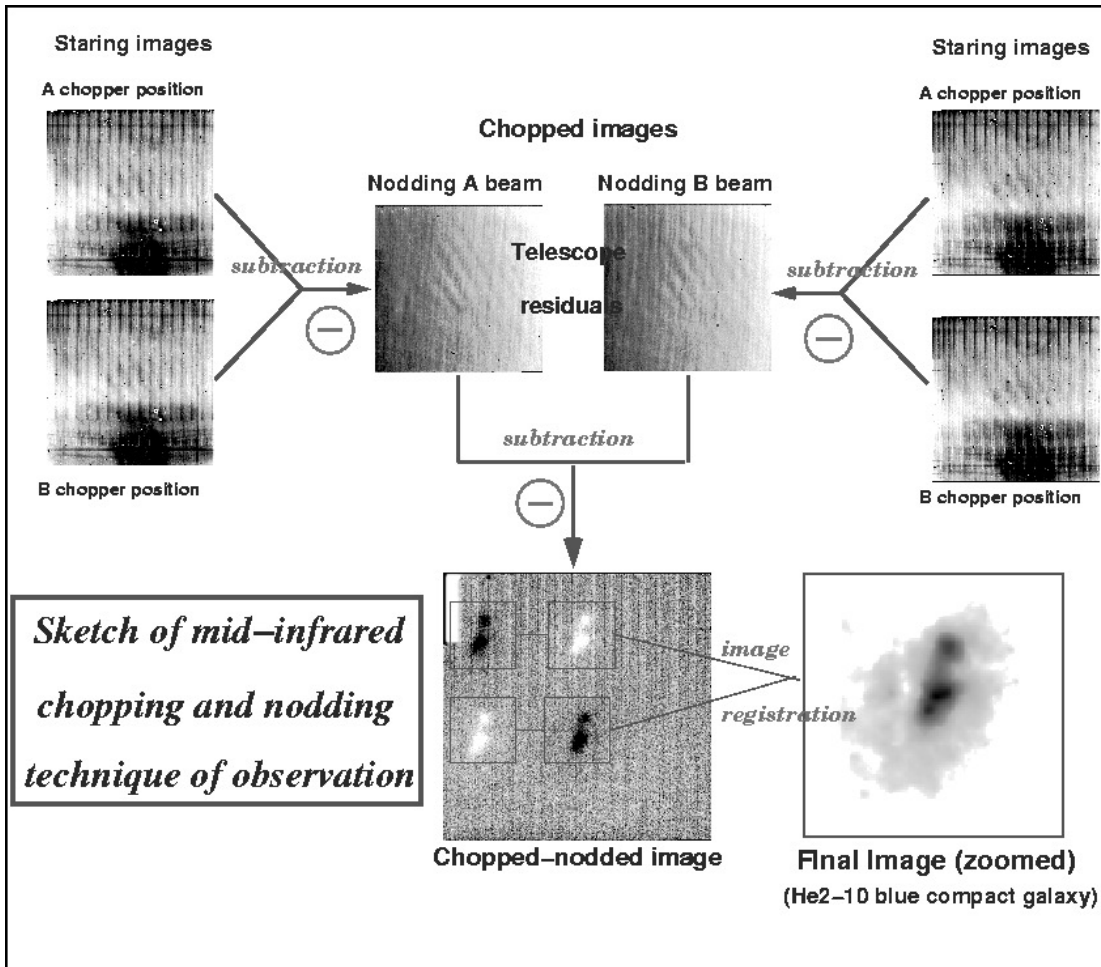

Figure 4: Illustration of the chopping and nodding technique on observations of the blue compact galaxy He2-10. The galaxy only appears after chopping and nodding (courtesy VISIR commissioning team, June 2004).

The growing calibration database allows a statistical analysis of the sensitivity with respect to instrumental and atmospheric conditions. The values for each filter given in Table 2 refer to the median of more than 600 different observations during September and December 2004. A graphical compilation is presented in Fig. 5 for the N-band and Q-band imaging filters. Some of the best measurements approach theoretical expectations, i.e. they are close to background limited performance (BLIP).

Sensitivity estimates for the VISIR spectroscopy observing modes are obtained in a similar way. However, in this case, chopping and nodding are executed in parallel. Consequently, only 3 beams are obtained, with the central one containing twice as much flux as the two other ones.

Table 5 to 6 list typical sensitivities measured in low, medium and high resolution modes away from strong sky emission lines for the wavelength ranges offered in P76. Figures 20 to 36 in the Appendix (§ 11) shows the dependence of sensitivity on wavelength.

The median sensitivities are the reference for classification of VISIR service mode observations, and the basis to assess the feasibility of an observing programme. In particular, *classification* of service mode OBs will be based on sensitivity measurements made at zenith. Calibrations will be provided following the guidelines given in § 5.7. For up to date information, please consult <http://www.eso.org/instruments/visir>. The use of the VISIR exposure time calculator (ETC, located at <http://www.eso.org/observing/etc/>) is recommended to estimate the on-source integration time.

4 Instrument description and offered observing modes

VISIR offers two spatial scales in imaging and several spectral resolution modes in slit spectroscopy. The imager and spectrograph are two sub-instruments. They have independent light paths, optics and detectors. The cryogenic optical bench is enclosed in a vacuum vessel. The vessel is a cylinder, 1.2 m long and 1.5 m in diameter. Standard Gifford-McMahon closed-cycle coolers are used to maintain the required temperature: 33 K for most of the structure and optics and < 15 K for the parts near the detector. The detectors are cooled down to ~ 5 – 6 K.

4.1 Imager

The imager is based on an all-reflective design. The optical design is shown in Fig. 6. It consists of two parts:

- A collimator, which provides an 18 mm diameter cold stop pupil in parallel light: As generally designed for IR instruments, the pupil of the telescope is imaged on a cold stop mask to avoid straylight and excessive background emission. The collimator mirror (M1) is a concave aspherical mirror. It is followed by a folding flat mirror (M2) which eases the mechanical implementation.
- A set of three objectives mounted on a wheel. Each objective is based on a three mirror anastigmatic (TMA) system. Each of the TMA's is made of three conic mirrors.

The 0.045'' (small field, SF) and 0.076'' (intermediated field, IF) pixel scale are offered (Table 1). These offered pixel fields of view (pfov) ensure a proper sampling of the images in the N and Q-band. The filter wheel is located just behind the cold stop pupil mask. The list of filters offered is given in Table 2. The transmission curves of the filters measured at 35 K are plotted in the Appendix.

Starting Period 81, another set of filters is offered, their characteristics are summarized in Table 3.

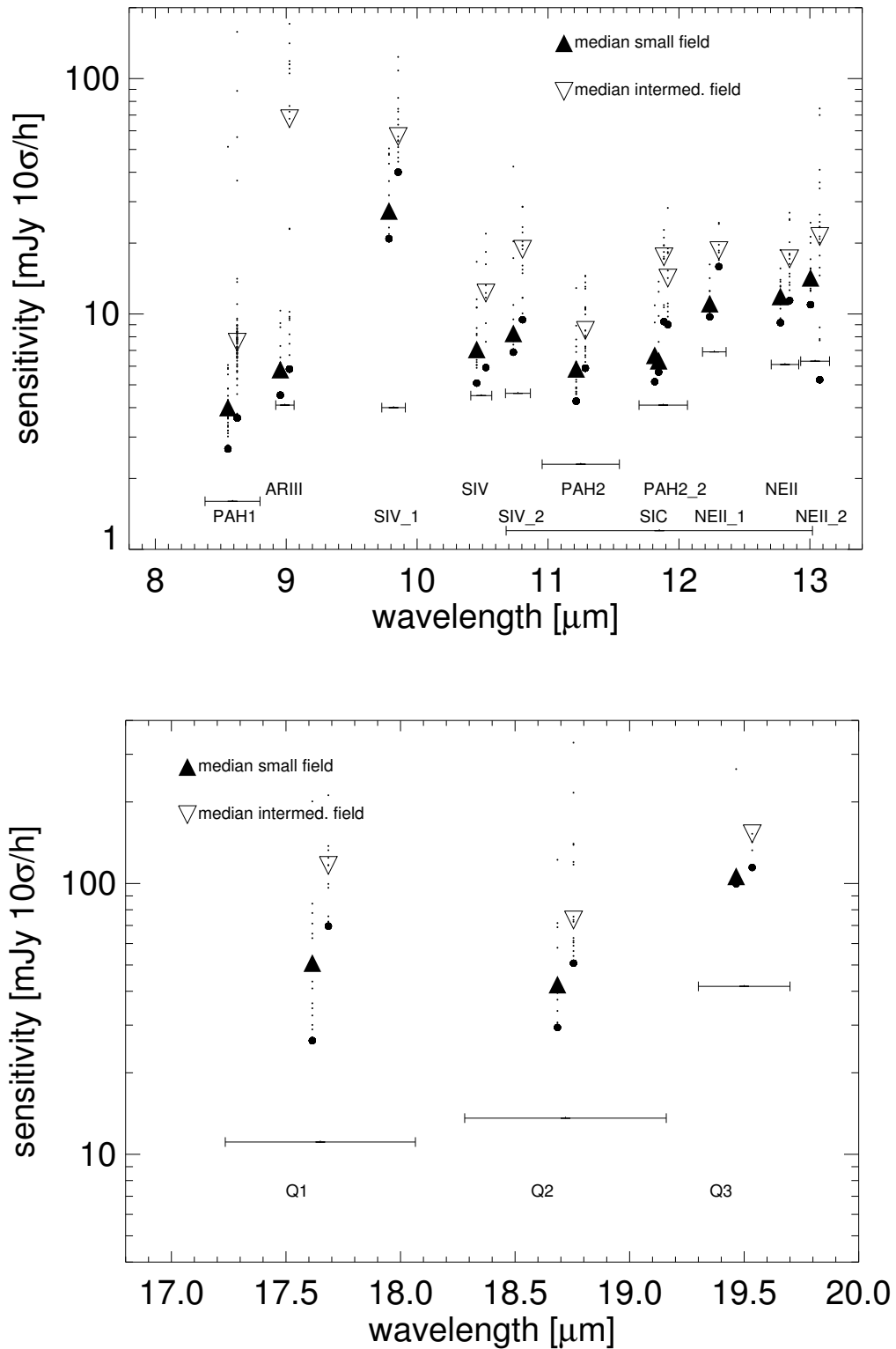

Figure 5: **Measured on the old DRS detector but also valid for Period 90.** Sensitivities for the VISIR imager for the N (top) and Q-band (bottom). Small and intermediate field observations are displaced for clarity. Background noise limits are indicated for the individual filter bandpasses.

Pixel size	Field of view
0'.076	78'' × 78''
0'.045	46'' × 46''

Table 1: VISIR imager pixel scales offered. The pixel size of the AQUARIUS 1k×1k detector is 30 μm .

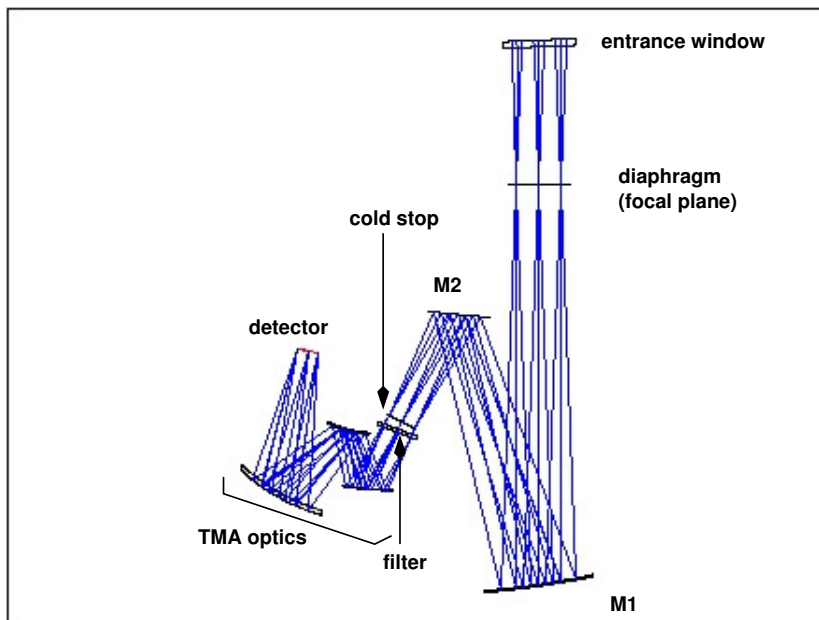

Figure 6: The optical path of the imager in the intermediate field (0'.076) is shown from the entrance window down to the detector.

filter	λ_c (μm)	half-band width (μm)	maximum transmission (%)	sensitivity (mJy $10\sigma/1\text{h}$)		
				theory (BLIP)	median SF IF	
PAH1	8.59	0.42	77	1.6	5	8
ArIII	8.99	0.14	72	4.1	6	70
SIV_1	9.82 ¹	0.18	72	4.0	30	60
SIV	10.49	0.16	70	4.5	8	13
SIV_2	10.77 ¹	0.19	70	4.6	9	20
PAH2	11.25	0.59	75	2.3	6	9
SiC	11.85	2.34	75	1.2	7	18
PAH2_2	11.88 ¹	0.37	58	4.1	7	15
NeII_1	12.27 ¹	0.18	51	6.9	12	20
NeII	12.81	0.21	64	6.1	12	18
NeII_2	13.04	0.22	68	6.3	15	22
Q1	17.65	0.83	59	11.1	50	120
Q2	18.72	0.88	49	13.6	50	80
Q3	19.50	0.40	50	41.7	100	160

Table 2: **Sensitivity values are still valid for Period 90 proposal preparation.** VISIR imager filter characteristics, following the manufacturer specifications, except for the central wavelengths noted with ¹ which were re-determined with a monochromator and the WCU because they deviate from specifications. The last 3 columns give, respectively, the theoretical expectations under BLIP and excellent weather conditions, and the measured median sensitivities for the Small and Intermediate Field obtained in various weather conditions. The measured sensitivities were obtained using the curve-of-growth method on data obtained in perpendicular chopping/nodding directions (4 beams).

filter	λ_c (μm)	half-band width (μm)	sensitivity (mJy $10\sigma/1\text{h}$)	
			SF	IF
B 8.7	8.92	0.97	-	-
B 9.7	9.82	0.84	9	20
B 10.7	10.65	1.37	5	8
B 11.7	11.52	0.85	5	6
B 12.4	12.47	0.99	8	12
J 7.9	7.76	0.55	14	25
J 8.9	8.70	0.73	3	5
J 9.8	9.59	0.94	7	10
J 12.2	11.96	0.52	8	10

Table 3: **Sensitivity values are still valid for Period 89 proposal preparation.** VISIR imager filter characteristics determined with a monochromator and the WCU. The last 2 columns give the measured median sensitivities for the Small and Intermediate Field obtained in good weather conditions. The measured sensitivities were obtained using the curve-of-growth method on data obtained in perpendicular chopping/nodding directions (4 beams).

The burst read out is offered for the imager in visitor mode only. The burst read out allows the user to save every single DIT frame of the exposure. In this way it is possible to follow rapidly evolving events or to improve the spatial resolution by taking short enough exposures to freeze the atmospheric turbulence. This mode can be used only for objects bright enough to provide a S/N high enough in a single elementary exposure. Typical flux limits are of the order of 5 Jy in N and 10 Jy in Q. Some compromise between sensitivity and time resolution can be reached by averaging a number of elementary frames. Further and more up-to-date information can be found at: <http://www.eso.org/instruments/visir/inst/>.

4.2 Spectrometer

VISIR offers slit spectroscopy at three spectral resolutions with a pixel scale of $0''.076$. This is obtained by means of two arms, one with low order gratings for the low and medium spectral resolution, the other with large echelle gratings providing high spectral resolution.

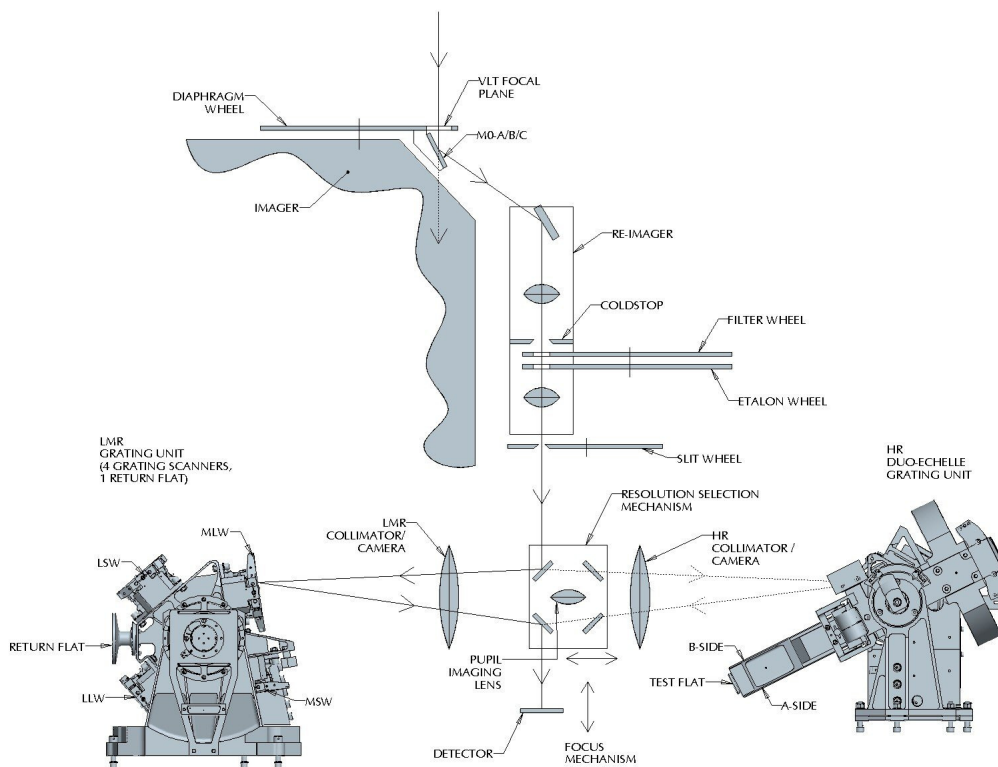

Figure 7: Schematic layout of the design of the VISIR spectrometer.

The long slits have a length of 32.5'' and therefore cover the whole width of the detector. The short slits, only used in high-resolution cross-dispersed mode, have a length of 4.1''. The all-reflective optical design of the spectrometer uses two TMA systems in double pass (pass 1: collimator, pass 2: camera). A schematic layout of the VISIR spectrometer design is shown in Fig. 7. The 3-mirror system of the low- and medium-resolution arm gives a 53 mm (diameter) collimated beam; the collimated beam diameter in the high-resolution arm is 125 mm. Both subsystems image the spectrum onto the same detector; selection between the two spectrometer arms is done by two pairs of folding flat mirrors. In front of the actual spectrometer subsystems is a reflective re-imager consisting of two off-axis paraboloids and three folding flats. The re-imager provides a 16 mm diameter cold-stop pupil in parallel light and transforms the incoming VLT Cassegrain beam of F:13.4 to an F:10 beam at the spectrometer entrance. The spectrometer slit wheel is also equipped

with a very wide slit (15.3'') named OPEN in P2PP. It gives the possibility to make imaging with the spectrometer detector and is used for object acquisition and centering on the detector.

The list of available filters for spectroscopic acquisition offered is given in Table 4, together with their measured bandpasses and approximate sensitivities for image acquisition.

filter	λ_c (μm)	half-band width (μm)	sensitivity (mJy/10 σ /1h)
N_SW	8.85	1.35	40
N_LW	12.1	1.9	40
ArIII	8.94	0.11	200
NeII_1	12.35	0.50	80
NeII_2	12.81	0.10	50

Table 4: VISIR spectrometer filter characteristics. The filters transmissions have been determined with a monochromator and the WCU. The last column list the measured median sensitivities which were obtained using the curve-of-growth method on data obtained in parallel chopping/nodding directions (3 beams).

4.2.1 Slit widths

Three different slit widths (0.4'', 0.75'' and 1'') are offered for all settings. For over-sized widths (e.g. for the 1'' slit with respect to the diffraction limit around 10 μm) the spectral resolution of a point-source spectrum is better than the one of the sky spectrum; in addition, the zero-point of the wavelength calibration will be affected by an incorrect centering of the object within the slit.

4.2.2 Resolution

In the N band, the low-resolution and medium resolution modes provide spectral resolving power of ~ 300 and ~ 3000 (Table 5), respectively. In high resolution long-slit mode, narrow wavelength ranges around the 8.02 [H2_S4], 12.813 [Ne II] and 17.03 μm [H2_S1] line are offered. With the 1'' slit the measured spectral resolution is $R \sim 15000$ (Table 6), and a minimum flux in an emission line below 10^{-16} W/m²/arcsec² can be achieved. This value corresponds to an approximate sensitivity limit around 1 Jy in the continuum. A high-resolution, cross-dispersed mode with a 4.1'' short slit is available for a number of wavelength settings (Table 6).

Please consult <http://www.eso.org/instruments/visir> for the latest update of the list of offered modes and slits.

4.2.3 Low resolution: offered central wavelengths

Following the VISIR upgrade project, and throughout Period 90, the N-band 8 – 13 μm Low Resolution Spectroscopy will require only one exposure to cover the 8 – 13 μm range. This is achieved by replacing the current gratings with a new ($R \simeq 300$ for a 0'.3 slit) prism. The sensitivities measured on the old DRS detector still apply for Period P90 proposal preparation. These are ~ 50 mJy at 10 σ /1h in the clean regions of the spectrum. Offered slits have widths of 0.40, 0.75 and 1.00''.

4.2.4 Medium resolution: offered central wavelengths

In Medium Resolution mode, the central wavelength λ_c can be freely chosen within the wavelength ranges listed in Table 5. Note that the exposure time calculator (ETC) cannot currently provide estimates of S/N for $\lambda < 7.6\mu\text{m}$. Table 5 provides offered sensitivities.

λ_c – range (μm)	$\Delta\lambda$ (μm)	grating order	spect.–resol. (measured, 1''slit)	dispersion (pixels/ μm)	sensitivity (mJy at 10σ in 1h)
7.5 – 8.0	0.195	2	~ 3500	~ 2192	1000
8.0 – 9.3	0.188	2	~ 3500	~ 2267	200
10.2 – 13.0	~ 0.21	2	~ 3500	~ 2417 – 1733	200
17.1 – 19.0	0.37	1	~ 1800	~ 1158	1200
20.12	0.36	1	~ 1800	720	1200

Table 5: VISIR medium resolution settings. The first column gives the minimum and maximum allowed values for the central wavelength (λ_c) in the given setting. The wavelength range per setting is given in the 2nd column ($\Delta\lambda$). The spectral resolution, measured with a 1''slit, is given in the 3rd column. **The dispersion is given in the 4th column, and has been estimated for the new AQUARIUS detector pixel size.** Typical offered sensitivities are given in the last column. Examples of dependence of sensitivity with wavelength are shown in Figures 21 to 24. Offered slits have widths of 0.40, 0.75 and 1.00''.

4.2.5 High resolution: offered central wavelengths

The VISIR spectrometer offers a high-resolution long-slit mode for 3 passbands centered in the wavelengths of the [H2_S4], [NeII] and [H2_S1] lines. A wider range of wavelengths is accessible with the high-resolution cross-dispersed mode, with a 4.1'' long slit.

Offered modes and sensitivities are given in Table 6. The ETC offers the possibility to take into account the earth motion to predict the observed wavelength of a given line depending on the foreseen date and time of observations. In particular, this feature allows to determine the dates when the emission line under study would appear at the same wavelength as a sky line.

4.3 Calibration units

A warm calibration unit (WCU) is located on top of the VISIR vacuum enclosure. The WCU is also called star simulator. It simulates either a monochromatic point source with adjustable wavelength or an extended black-body source with adjustable temperature. A selection mirror allows to switch from the telescope to the simulator beam. It can be used for calibration and tests, also during daytime. Fig. 8 shows the unit on top of the enclosure.

4.4 Detectors

The VISIR imager and spectrometer will be equipped with the new AQUARIUS $1k \times 1k$ detector. The quantum efficiency will be provided following the commissioning of the detector.

At the operating temperature of the detector ($\sim 6\text{ K}$), the dark current, which is the signal obtained when the detector receives no photons, is negligible compared to the background generated by the photons emitted by the telescope and the atmosphere. The dark current is removed by the observation technique (chopping or nodding).

mode	λ_c (μm)	$\Delta\lambda$ (μm)	line	order	R	dispersion (pixels/ μm)	sensitivity Jy $10\sigma/1\text{h}$
HR	7.800 – 8.100	0.02420	[H2_S4]	17B	32000	17573	~3
HR	12.738 – 12.882	0.03571	[Ne II]	11A	17000	11908	~0.9
HR	16.800 – 17.200	0.05156	[H2_S1]	8B	14000	8250	<10
HRX	8.970 – 9.140	0.02270	[ArIII]	16A	27100	18757	~ 4
HRX	9.360 – 9.690	0.02325	[H2_S3]	15A	25000	18290	~5
HRX	10.480 – 10.540	0.03160	[SIV],[CoII]	12B	24000	13407	~4
HRX	11.540 – 11.570	0.03210	HD (0,0) R(10)	12B	23400	13333	~ 2
HRX	11.762	0.03260	[CIIV]	12A	19100	13067	~ 3
HRX	12.210 – 12.760	0.03864	[H2_S2]	11B	20000	11007	~1.5
HRX	12.814 – 13.364	0.03550	[NeII]	11A	17500	11917	~2
HRX	16.390	0.03551	[CoIII]	9A	17300	12100	~ 12
HRX	16.925	0.05240	[CoI]	8B	14100	8067	~ 8
HRX	17.790 – 17.980	0.04707	[PIII],[FeII]	8A	13140	9000	~ 4
HRX	18.246	0.04182	[NiII]	8A	14600	10133	~ 8
HRX	18.680 – 18.960	0.06569	[SIII]	7B	11150	6450	~ 4
HRX	21.295	0.04196	[NaIV]	7A	14300	10097	~ 9

Table 6: VISIR high resolution long-slit (HR) and cross-dispersed (HRX) modes. The second column gives the minimum and maximum allowed values for the central wavelength (λ_c) in the given setting. The wavelength range per setting is given in the 3rd column ($\Delta\lambda$). R is the theoretical spectral resolution. Offered slits have widths of 0.40, 0.75 and 1.00". Note that the range 12.210 – 12.760 also covers HD (0,0) R(9), while the [NeII] emission line can be observed up to $z \approx 0.038$. **The dispersion is given in the 7th column, and has been estimated for the new AQUARIUS detector pixel size.**

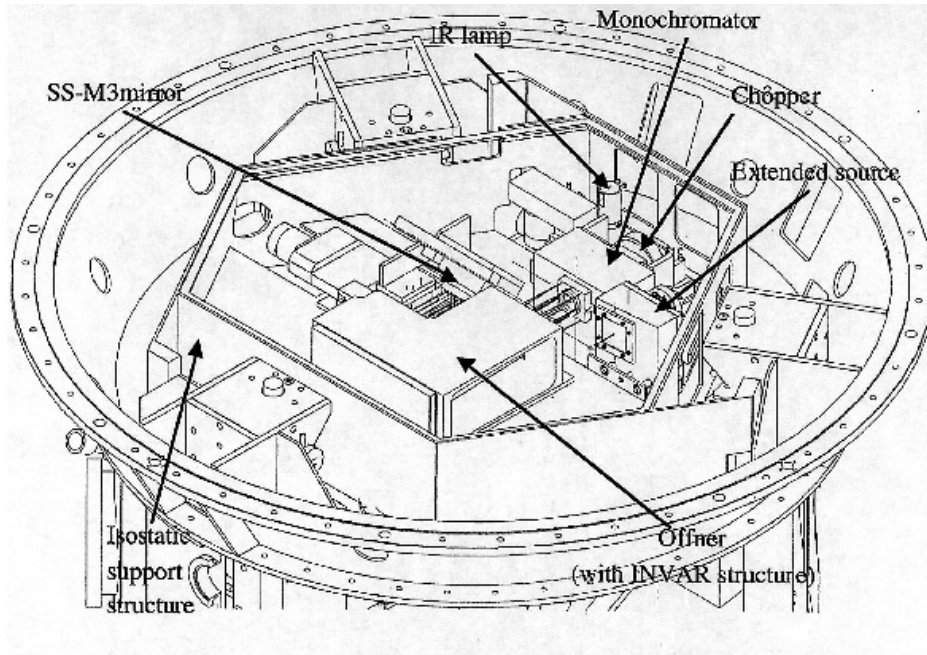

Figure 8: Schematic drawing of the warm calibration unit on top of the VISIR vessel.

The detectors have a switchable pixel (“well”) capacity. The large capacity is used for broad-band imaging and the small capacity for narrow band imaging and spectroscopy. Detector saturation due to the enormous MIR background is avoided by a storage capacity of $0.6 \cdot 10^6 e^-$ in small and $6.0 \cdot 10^6 e^-$ in large capacity modes, respectively. The detector integration time (DIT) is a few milli-seconds in broad-band imaging and may increase to ~ 2 s in high resolution spectroscopy. The DIT is determined by the instrument software according to the filter and pfov. It is not a parameter to be chosen by the observer.

The new AQUARIUS detector cosmetic testing shows that it does not show the fair fraction of bad pixels seen in the old DRS detector. Moreover, the AQUARIUS detector can be considered free from stripping effects and ghosts. For period 90, it is still advised to observe only sources fainter than 500 Jy in N and 2500 Jy in Q. Due to the low flux levels, eventual detector artifacts are less important in spectroscopy. As in previous periods however, it is advised that a TEL.CHOP.THROW between 9 to 13'' should be avoided, until a full characterization of the AQUARIUS detector is done.

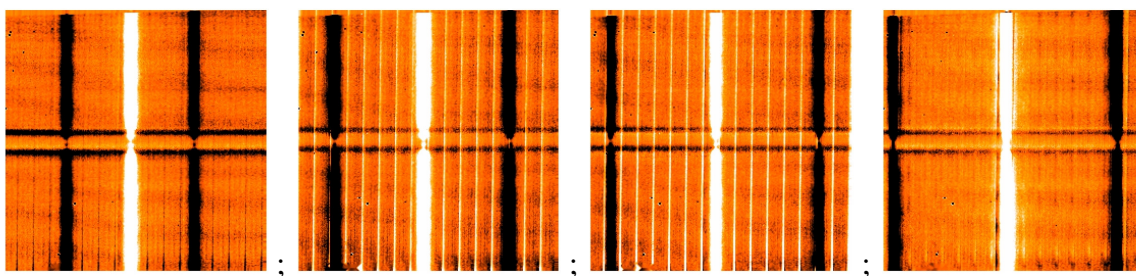

Figure 9: **An example of the bad cosmetics on the old DRS detector.** Sequence of chop/nod, reduced spectra obtained in the Medium Resolution mode with a central wavelength = $8.8\mu\text{m}$. The TEL.CHOP.THROW = 8, 11, 13 and 14'' from left to right. Note the presence of significant striping when the ‘left’ beam hits some hot pixels at the lower left of the detector. For the location of the object along the slit (pixel X=123 at row Y = 128), this occurred for TEL.CHOP.THROW between 10 and 13'', approximatively. The horizontal lines at the middle of the images are caused by the lack of detector response at $8.8\mu\text{m}$.

4.5 Data acquisition system

As part of the upgrade project, the VISIR new AQUARIUS detectors will be controlled by an NGC acquisition system. In imaging the read-out rate of the detector is high. Up to 200 frames per s are read for a minimum detector integration time of DIT= 5 ms. Such a frame rate is too high to store all exposures. One VISIR image is of size 1024×1024 ; each pixel is coded with 4 bytes (long integer). Thus one read-out has a size of 262 kB. During each chopping cycle the elementary exposures are added in real time and only the result is stored on disk. At a chopping frequency of $f_{\text{chop}} = 0.25$ Hz every $T_{\text{chop}} = 4$ s one VISIR image is stored as a plane in a data cube of a FITS file. The number of chopping cycles, within one nodding position, is defined by the time spent integrating in that nodding position, T_{nod} . This nodding period is typically $T_{\text{nod}} = 90$ s for science observations. The chopper frequency, DIT and also T_{nod} are predefined by the system. The number of saved A–B frames in one FITS file is:

$$N_{\text{cycl_chop}} = T_{\text{nod}}/T_{\text{chop}} \quad (1)$$

The number of nodding cycles is computed from the total integration time as given by the observer. The total number of stacked images for each secondary position, respectively chopper half cycle, is NDIT. This parameter is computed according to:

$$\text{NDIT} = (2 \cdot \text{DIT} \cdot f_{\text{chop}})^{-1} - \text{NDITSKIP} \quad (2)$$

and is given by the system. It depends on DIT, chopping frequency and NDITSKIP: some read-outs at the beginning of each chopper half cycle are rejected during stabilization of the secondary. Typical stabilization times of the secondary are 25 ms. The number of rejected exposures is given by NDITSKIP. Similar, during stabilization after each telescope movement, respectively nodding position, a number NCYSKIP of chopping cycles is ignored. The timing organization of data is shown in Fig. 10.

The total on source integration time is:

$$t_{\text{source}} = 4 \cdot N_{\text{cycl_nod}} \cdot N_{\text{cycl_chop}} \cdot \text{NDIT} \cdot \text{DIT} \quad (3)$$

The total rejected time is:

$$t_{\text{skip}} = 4 \cdot N_{\text{cycl_nod}} \cdot \text{DIT} \cdot (\text{NDITSKIP} \cdot N_{\text{cycl_chop}} + \text{NDIT} \cdot \text{NCYSKIP}) \quad (4)$$

and the total observing time is:

$$t_{\text{tot}} = t_{\text{source}} + t_{\text{skip}} \quad (5)$$

Typical duty cycles ($t_{\text{source}}/t_{\text{tot}}$) are about 70%.

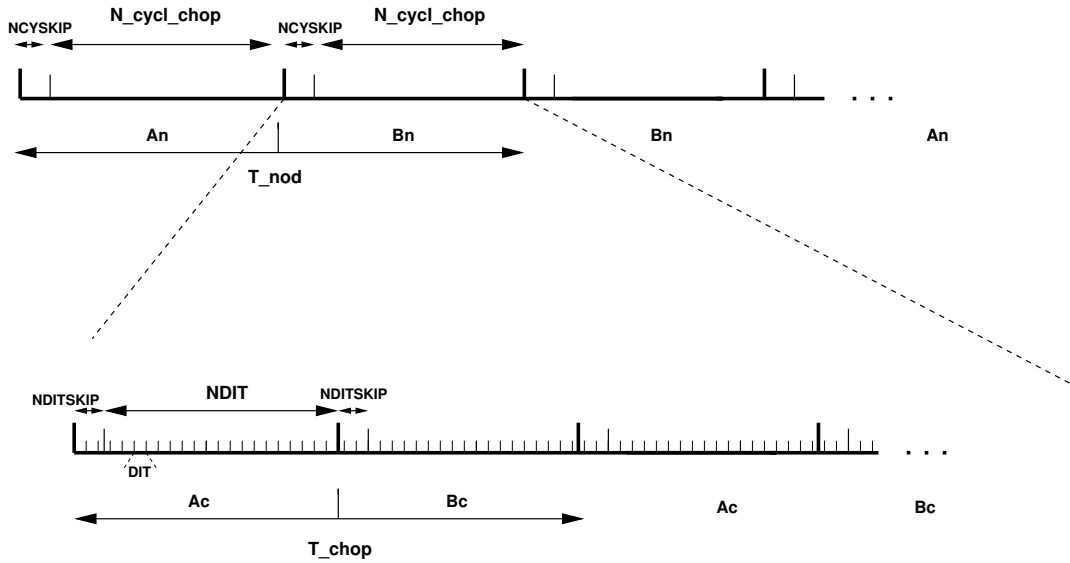

Figure 10: Data timing in VISIR. Ac and Bc refer to the two chopper positions, An and Bn refer to the two nodding (telescope) positions. Note the AnBnBnAn cycle sequence for the nodding to save observing time.

5 Observing with VISIR at the VLT

5.1 Proposal preparation

Tools are available to prepare the observations, either during phase 1 (call for proposals), or during phase 2 (creation of observing blocks by the observer):

- The *exposure time calculator* (ETC available at <http://www.eso.org/observing/etc/>) may be used to estimate the integration time needed to obtain the required S/N for a given instrument setting; because of the numerous sky absorption lines, (see Fig. 20 and following), it is recommended to display the S/N as a function of wavelength when using the spectrograph ETC. This advice is particularly relevant for spectroscopic settings with wavelengths centered at $8.8\mu\text{m}$ as they will be strongly affected by the detector feature at this wavelength.
- As for all VLT instruments, astronomers with granted VISIR telescope time prepare their observations using *the phase 2 proposal preparation tool* (P2PP), described at <http://www.eso.org/sci/observing/phase2/P2PPTool.html>. Acquisitions, observations and calibrations are coded via observing templates. One or more templates build up an observing block (OB). They contain all the information necessary for the execution of a complete observing sequence. An overview of the available VISIR templates and their parameters is given in §7 of this manual.
- For each science template, the user has to provide a finding chart so that the target can be acquired. In addition to the general instruction on how to create these finding charts, see <http://www.eso.org/sci/observing/phase2/SMGuidelines.html>, the following VISIR requirements apply:
 - All finding charts have to be made using existing infrared (K-band or longer wavelength) images. Typically, 2MASS or DENIS K-band images are acceptable, although higher spatial resolution may be preferable.
 - If the wavelength at which the finding chart has been taken is different from that of the science observation, e.g. a K-band finding chart for a $10\mu\text{m}$ spectroscopic template, the user has to describe clearly how to identify the target at the observing wavelength in the README section of the programme description. Adequate examples of such comments are:
 - * The target will be the brightest source in the field of view at $10\mu\text{m}$.
 - * At $10\mu\text{m}$, there will be two bright sources in our field of view. The science target is the southernmost of these two.
- It is mandatory to check that a guide star brighter than $V=13$ within a field of 7.5 arcmin radius around the science target is available. This can be done using the guidecam tool (see <http://www.eso.org/instruments/visir/doc>). See § 5.4

Note that observations close to zenith during meridian crossing should be avoided, because of fast tracking speeds that do not allow proper background cancelation after nodding.

A final recommendation concerning service mode observations is that no more than 5 filters are grouped together in a single Observing Blocks. This is rather necessary for a proper calibration of each single filter. Moreover, it is also recommended that N and Q band filters are not grouped together as the Q-band sensitivities can be quite lower from that in the N-band.

Questions related to the VISIR Phase1 and Phase 2 observing preparation should be directed to the User Support Department (usd-help@eso.org).

5.2 Telescope observing parameters

5.2.1 Instrument orientation on the sky

By default, the imager orientation is such that North is at the top and East is to the left. For the spectrometer, the default orientation is rotated by 90° respective to the imager, so that the North is to the left and the East to the bottom, with the slit orientation along the North-South direction. Figure 11 summarizes the situation.

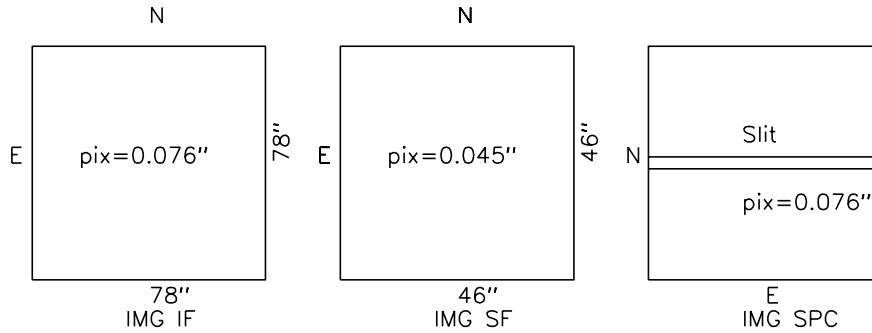

Figure 11: Field orientation and scale for the imaging and spectroscopic modes of VISIR.

Since VISIR is mounted on a rotator at the Cassegrain focus of Melipal, it is possible to change the default orientation of VISIR on the sky, for example, to obtain the spectra of two objects, A and B, at once. The parameter `TEL.ROT.OFFANGLE`, defaulted to 0° , is used for this purpose. If PA represents the required position angle of object B relative to A, measured on the sky east of north (i.e., counted positively from north to east) within the range 0 to 360° , then setting

$$\text{TEL.ROT.OFFANGLE} = 360 - PA$$

allows one to have both A and B objects on the slit.

5.2.2 Chopping parameters

The chopping technique, as described in § 3, is based on beam switching using the moving secondary mirror of the telescope. It allows to alternatively observe a field, then another field offset from the first by a chopping distance or throw, called `TEL.CHOP.THROW`, see Fig. 12. This parameter can be set by the user. To avoid chopping inside the object it is recommended to use a chopping and nodding throw which is ~ 1.5 times larger than the estimated MIR diameter of the object. In the case of point sources, the throw is usually set around $\sim 10''$ to ensure proper separation of the different beams. The maximum chopping throw at the VLT is $30''$ and the minimum is $8''$. For good image quality, and good background cancelation, chopping and nodding throws below $15''$ are recommended (see § ??). *Note that for chopping throws larger than the field-of-view, the negative beams will not be seen on the detector, and the integration times have to be adjusted accordingly.*

The chopper position angle, PA , is the angle of chopping counted East of North (see Fig. 12). This parameter can be set by the observer. In order to keep the same distribution of beams on the detector for a different rotator angle (`TEL.ROT.OFFANGLE`) as in the default rotator position (see Fig. 14), then `TEL.CHOP.POSANG` must be equal to `TEL.ROT.OFFANGLE`. In particular, this is the case in spectroscopy if the observer wishes to have the 3 beams along the slit. As stated in § 3.5, the chopping frequency is not a parameter accessible to the observer, it is fixed internally to ensure the best data quality.

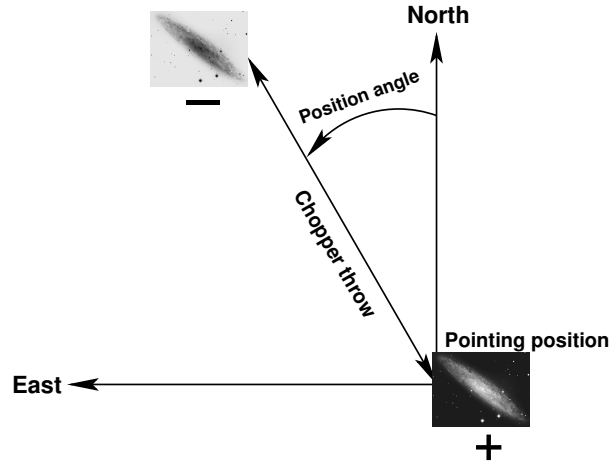

Figure 12: Definition of chopping parameters from the *telescope* point-of-view. If the position angle (*PA*) is measured counter-clockwise from North to East with *PA* between 0 and 360°, then `TEL.CHOP.POSANG` is $360^\circ - PA$. The positive beam (+) is obtained when the M2 is at Chopping Position A and corresponds to the pointing position of the telescope as given in the FITS header (idle position). The negative beam (-) is obtained by moving the M2 so that it points to a position angle on the sky given by *PA* and a throw of `TEL.CHOP.THROW` from the telescope pointing position (Chopping Position B). If `TEL.CHOP.POSANG = TEL.ROT.OFFANGLE = 360° - PA`, the resulting image on the detector will appear as in one of the nodding position images illustrated in Fig. 14.

5.2.3 Nodding parameters

The nodding technique allows to switch from one field to another by offsetting the telescope by several tens of arc-seconds. It allows to correct for optical path residuals that remain after chopping (§ 3).

The nodding period is a parameter that can only be modified by the instrument operator. For exposures shorter than 180s (`SEQ.TIME < 180s`) – as possible in acquisition images –, the nodding time is set to half the requested exposure time. For exposures longer than 180s, the nodding time is set to 90s. *In particular, exposure time given in the template will be internally changed by the software to be the closest to a multiple of 90s.*

In all the 'AutoChopNod' templates, the nodding offset is equal to `TEL.CHOP.THROW` and cannot be modified.

In order to reach Nodding Position B, the telescope executes an offset of `TEL.CHOP.THROW`, along a position angle equal to

- $PA + 90^\circ = 360^\circ - TEL.CHOP.POSANG + 90^\circ$, if `SEQ.CHOPNOD.DIR = PERPENDICULAR`,
- $PA + 180^\circ = 180^\circ - TEL.CHOP.POSANG$, if `SEQ.CHOPNOD.DIR = PARALLEL`.

The resulting distribution of images on a frame is illustrated in Fig.14. In imaging, more flexibility on the nodding offsets are possible with the `VISIR_img_obs_GenericChopNod` template.

5.3 Target acquisition

5.3.1 Introduction

Observing blocks (OB) must start with an acquisition template. Pointing to a target can only be performed through an acquisition template. The target coordinates, name and proper motion are all set in the acquisition templates.

The execution of the acquisition templates presets the telescope to the target coordinates given by `TEL.TARG.ALPHA` and `TEL.TARG.DELTA`. Offsets with respect to the target coordinates can be specified by `TEL.TARG.OFFSETALPHA` and `TEL.TARG.OFFSETDELTA` and allow, for example, to use a bright reference star for precise acquisition (see Fig. 13). To guarantee proper centering within the slit (when using a reference star) the angular separation between the reference star and the target should not be larger than 60". Acquisition with a reference star has not been tested with the narrow, 0.4" slit and should be avoided. Note that the coordinates of the target (`TEL.TARG.ALPHA`, `TEL.TARG.DELTA`) and the offsets to the reference star (`TEL.TARG.OFFSETALPHA`, `TEL.TARG.OFFSETDELTA`) must be indicated in the acquisition template. Thus, the following convention² :

$$\text{TEL.TARG.ALPHA} + \text{TEL.TARG.OFFSETALPHA} = \text{RA}(\text{offsetstar}),$$

$$\text{TEL.TARG.DELTA} + \text{TEL.TARG.OFFSETDELTA} = \text{DEC}(\text{offsetstar}).$$

will be used and the telescope is preset to the reference star. Once the reference star is properly centered, `TEL.TARG.OFFSETALPHA` is subtracted back and the telescope is moved to the target.

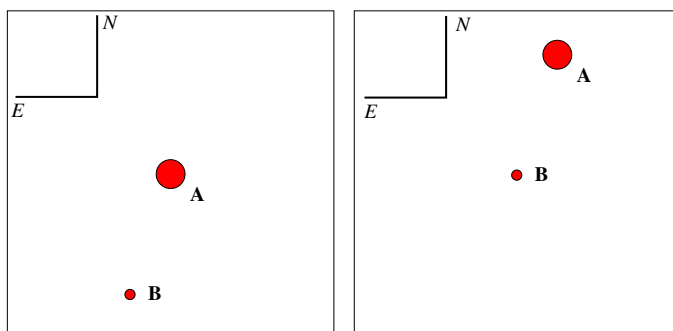

Figure 13: Setting the correct values of the `TEL.TARG.OFFSETALPHA` and `TEL.TARG.OFFSETDELTA` for a blind offset. Here the object A is a bright star used to center the target – the faint object B – at the center of the field. The telescope will first point at the object A. The instrument operator centers it properly. Once done, the telescope is offset so that object B is now properly centered and the observation templates can be executed. Following the convention described in the text, and since the target (object B) is at the east of the offset star, `TEL.TARG.OFFSETALPHA` is negative; on the other hand, the target is at the south of the offset star, so `TEL.TARG.OFFSETDELTA` is positive.

5.3.2 Description

There are two acquisition templates for imaging, `VISIR_img_acq_Preset` and `VISIR_img_acq_MoveToPixel`. Two acquisition templates are also available for spectroscopy, `VISIR_spec_acq_MoveToSlit` and `VISIR_spec_acq_ImgMoveToSlit`. The latter one allows to perform spectroscopic acquisition with the imager detector (in intermediate field only) and therefore offers the possibility to acquire fainter objects in a larger variety of filters. The observing parameters are described in § 9.

The effect of all acquisition templates is first to point the telescope so that the coordinates at the center of the detector match

- the target coordinates, if no blind offset is used,

²This convention is identical to the UVES one, but differs, from example, from the ISAAC or NACO one.

- the offset star coordinates, otherwise,

within the accuracy of the VLT pointing (see below). For `VISIR_spec_acq_MoveToSlit`, the first acquisition images are obtained with the OPEN (15.3'') slit. For `VISIR_spec_acq_ImgMoveToSlit`, the first acquisition images are obtained with the imager detector, Intermediate Field.

Then,

- The `VISIR_img_acq_MoveToPixel`, `VISIR_spec_acq_MoveToSlit` and `VISIR_spec_acq_ImgMoveToSlit` requires interaction with the instrument operator or night support astronomer in order to center the target at the appropriate location on the detector. Without further indication given by the observer, the default locations are:
 - for `VISIR_img_acq_MoveToPixel` and `SEQ.CHOPNOD.DIR = PARALLEL`: the center of the detector;
 - for `VISIR_img_acq_MoveToPixel` and `SEQ.CHOPNOD.DIR = PERPENDICULAR`: in the top left quadrant of the detector, at a distance equal to `TEL.CHOP.THROW/2` from the center of the detector in both X and Y;
 - for `VISIR_spec_acq_MoveToSlit`: at the center of the chosen slit;
 - for `VISIR_spec_acq_ImgMoveToSlit`: at the center of the imager detector,

Spectroscopic acquisition using the imager detector, with the `VISIR_spec_acq_ImgMoveToSlit` template, is limited to airmass smaller than 1.4 and slit width of 0.75 and 1.00''. In service mode, acquisition with the `VISIR_spec_acq_MoveToSlit` template is limited to objects brighter than 0.2 Jy.

All acquisition images are recorded and archived. Note that, *except if specifically requested in the README file*, photometric standard stars are not necessarily observed in the same filter as the acquisition filters.

As part of the execution of the `VISIR_spec_acq_MoveToSlit` and `VISIR_spec_acq_ImgMoveToSlit` templates, an image used to measure the slit location is always taken and archived. In service mode, through slit images, obtained using the filter set by the `INS.FILT2.NAME` parameter, are also taken and archived so that the user can assess the correct centering of her/his object. The slit location image and the through-slit images are automatic procedures. Only the exposure time of the through-slit images can be modified by a service mode observer. Their execution time is included in the advertised execution time of the spectroscopic acquisition template.

- If the target coordinates are well known, VISIR imaging modes allow to perform blind preset observations with the `VISIR_img_acq_Preset` template. In this case, no acquisition images are taken.

By default, if `TEL.TARG.ALPHA` and `TEL.TARG.DELTA` contain the (accurate) coordinates of the target, the target will be located at the center of the detector, *including if the observing templates use* `SEQ.CHOPNOD.DIR = PERPENDICULAR`. In this case, in order to avoid to lose the chopnod images, it is advisable either to

- change the parameters `TEL.TARG.ALPHA` and `TEL.TARG.DELTA` so that they are offset by half the `TEL.CHOP.THROW` values, to south and west for `TEL.ROT.OFFANGLE = TEL.CHOP.POSANG = 0`;

- or use the parameters `TEL.TARG.OFFSETALPHA` and `TEL.TARG.OFFSETDELTA`: as above, the convention ‘final coordinates (RA, DEC) of the center of the field plus offsets equal initial coordinates’ is used, which translates into

$$RA + TEL.TARG.OFFSETALPHA = TEL.TARG.ALPHA,$$

$$DEC + TEL.TARG.OFFSETDELTA = TEL.TARG.DELTA.$$

Therefore, if `TEL.ROT.OFFANGLE = TEL.CHOP.POSANG = 0`, `TEL.TARG.OFFSETALPHA` and `TEL.TARG.OFFSETDELTA` should be positive in order to reproduce the scheme shown in Fig. 14. A typical value for these parameters is `TEL.CHOP.THROW/2`, where `TEL.CHOP.THROW` is the chop throw used in the subsequent templates.

If both the target and guide star coordinates are within the same astrometric systems, the pointing accuracy is limited by the relative accuracy between the coordinates of the two objects. In particular, the pointing accuracy maybe affected by significant (usually unknown) proper motion of the guide star. Note that the observatory does not guarantee the accuracy of the world coordinate systems (WCS) keywords in the FITS headers.

Acquisition with the `VISIR_img_acq_MoveToPixel` or `VISIR_spec_acq_ImgMoveToSlit` templates can make use of the K-Band filter, for which a preliminary conservative limiting magnitude is ~ 12 in 60s on-source integration, for a $S/N = 10$.

Please note that the K-Band filter is not offered for science.

For a successful completion of an OB, the observer has to ensure that correct target coordinates are provided for the equinox J2000.0 ideally at the epoch of the observations³. The following cases require special care:

- *imaging in the small field*: in some conditions, an error of less than $10''$ on the coordinates can bring the target outside of the field;
- *spectroscopic acquisition*: in some conditions, an error of less than $7.5''$ on the coordinates can bring the target outside of the wide slit used.

Errors of such scale are common in the following situations:

- *high proper-motion stars*: in particular, if the epoch of the VISIR observations is significantly different from the epoch for which the coordinates were determined.
- *point-like sources within extended objects*: such as an AGN: a number of catalogues do not provide accurate coordinates of the nucleus. Coordinates given by 2MASS are more reliable.
- *coordinates obtained with low spatial resolution instrument*, such as MSX, etc...

For solar system objects, the J2000.0 equinox, topocentric, ICRF or FK5 coordinates at the epoch of the observations are required, as the Telescope Control System takes into account precession, nutation, annual aberration and refraction. On the contrary, the topocentric, *apparent* coordinates at the observatory, often used in other observatories, should *not* be used. Additional velocity parameters corresponding to $\mu(\alpha) \cos \delta$ and $\mu(\delta)$ must be given in $''/s$.

³In particular, note that P2PP only accepts coordinates for J2000.0

5.4 Guide stars

Guide stars are mandatory for active optics and field stabilization. Any VLT programme should make sure that a guide star (UCAC3) with a $R = 11 - 13$ mag is available within a field of $7.5'$ around the object.

Sensitivity in the mid-IR for a ground based observatory is strongly limited by the sky brightness. In addition, the VISIR field is small compared to other VLT instruments. Therefore images of a field can often appear empty in short to medium length exposures. However, objects may become visible in longer ones. Combining different exposures taken on different nights may be tricky if a proper astrometric alignment is not carried out. Since the overall astrometric accuracy of an image is actually limited by the accuracy on the coordinates of the guide star, it is strongly recommended that all OBs of a same field use the *same* guide star, in particular for faint objects.

In addition, objects within (optically) dark molecular clouds may have few or no suitable guide stars, at least in the catalogues currently used by the Telescope Control System: the UCAC3. Alternatively, some bright nebulae may saturate the region of the digital sky surveys used by the telescope operator to select guide stars. Considerable amount of telescope time will be saved if such cases are identified *before* an OB is started.

Providing the coordinates of a guide star in the acquisition template of an OB is therefore strongly recommended in a number of situations:

- observations of faint objects, hardly or not visible even after a long exposure, in particular, if this exposure has to be combined with other ones;
- observations of objects within (optically) dark molecular clouds where few suitable guide stars are expected;
- observations of objects within bright nebulae larger than the field of view accessible by the guide-probe that appeared saturated in the digital sky surveys (example: Orion);
- observations for which astrometric accuracy is important.

In all these cases, the use of the guidecam tool (see <http://www.eso.org/instruments/visir/doc>) for VISIR is strongly recommended and the coordinates of a suitable guide star should be inserted in the acquisition templates.

If `TEL.AG.GUIDESTAR` is 'CATALOGUE', a guide star from the guide star catalog will be automatically selected by the TCS. If `TEL.AG.GUIDESTAR` is 'SETUPFILE', the observer has to provide the coordinates of the GS. The coordinates of the guide star also fix the reference point for the World Coordinate System coordinates, that appear in the FITS header of the files.

In both cases, the telescope operator acknowledges the guide star. Depending on the weather conditions or if the star appears double in the guide probe, the telescope operator may have to select another guide star. Therefore, *if the observer has selected a guide star for astrometric purposes* – for example, to insure the repeatability of the pointings between different OBs –, *a clear note should be given in the README file*, for service mode observations, *or be specifically mentioned to the night time astronomer*, in visitor mode. As stated above, the observatory does not guarantee the accuracy of the world coordinate systems (WCS) keywords in the FITS headers.

5.5 Brightness limitations

There are currently no brightness limitations with VISIR. However, it is advised to observe only sources fainter than 500 Jy in N and 2500 Jy in Q to avoid detector artifacts (§ 4.4).

5.6 Overheads

The VLT overhead for one OB which includes active optics setting, selection of guide star, field stabilization is 6 min.

VISIR instrument configurations can be changed in a short time. For example a complete change of instrument settings takes less than 2 minutes. The total time for an image acquisition of a bright sources (> 1 Jy) takes ~ 5 min. for one fine acquisition iteration, or in blind preset 2 min. Spectroscopic acquisitions take longer and are strongly dependent on the source brightness : an overhead of 15 min. is accounted for sources > 1 Jy, while 30 min. are required for sources between 0.2 and 1 Jy, respectively.

Instrument overheads due to chopping and nodding duty cycle losses have been measured to be 50% of the observing time.

The total observing time requested by the observer must include telescope and instrument overheads.

5.7 Calibration observations

MIR observations depend strongly on the ambient conditions such as humidity, temperature or air-mass. In service mode science observations are interlaced by calibration observations on a timescale of 3h. Observations of photometric standards will be provided by the observatory within a time interval of three hours w.r.t. the science observations.

Calibrators, unless provided by the observer, are selected from the MIR spectro-photometric standard star catalog of the VLT (<http://www.eso.org/instruments/visir>). This catalog is a sub-set of the radiometric all-sky network of absolutely calibrated stellar spectra by Cohen et al.⁴. This list is supplemented by MIR standards used by TIMMI2 (see <http://www.ls.eso.org/lasilla/sciops/3p6/timmi/html/stand.html>).

At present the standard star catalog contains 425 sources. Zero point fluxes (Jy) have been calculated for the VISIR filter set by taking into account the measured transmission curves (Fig. 16), the detector efficiency and an atmosphere model (Fig. 1).

Continuous observations over 3 hours of the same standard star indicates that photometric stability better than 3% can be achieved with VISIR at the VLT. In order to test if a photometric precision of the same order can be obtained, a reduced set of standard stars has been built consisting of the Cohen et al. stars which obey the following criteria:

- visibility from Paranal;
- no variability detected by Hipparcos non-variables (Var = 0 in the Hipparcos catalogue);
- absolute flux calibration errors (as reported by Cohen et al.) $< 20\%$;
- all spectral types reported in SIMBAD no more than 1 sub-class different from that used by Cohen et al.;
- not visual binaries (as reported by SIMBAD).

This catalogue of 81 stars is also made available at <http://www.eso.org/instruments/visir>.

⁴Cohen et al., 1999, AJ 117, 1864

From this catalogue, a further selection to provide a reduced list of 12 stars has been carried out (see also <http://www.eso.org/instruments/visir>). These stars are distributed as uniformly as possible in Right Ascension, with spectral types as similar as possible. In addition, their flux in the N band, of the order of 10Jy, is bright enough to be observable in the Q band without reaching non-linearity levels in the N band even in non-ideal background conditions. At least one star in this reduced catalogue will be observed every night VISIR is in use. Note that this list could be modified without previous notice.

A PSF can be derived from these photometric standard star observations. However, it is not guaranteed that its S/N is sufficient for deconvolution purposes. If the observer requires a specific PSF measurement, (s)he has to provide the corresponding PSF OB.

Observations of photometric standards provided by the observatory are taken using the VISIR_img_cal_AutoChopNod template (§ 7) with the following settings:

SEQ.TIME	180 sec for N and 360 sec for Q band
TEL.CHOP.POSANG	0°
TEL.CHOP.THROW	10''
SEQ.CHOPNOD.DIR	PERPENDICULAR

Filter INS.FILT1.NAME and pixel scale INS.PFOV will be set according to the science observations.

In spectroscopy, the observatory will provide spectro-photometric observations of a telluric (K or M type) standard star in the Low Resolution mode, based on the same catalog as for imaging with an airmass difference no larger than 0.2 AM respect to the science target. Such a calibration measurement will be performed at least once per night, per instrument configuration. More precisely the following settings of the VISIR_spec_cal_LRAutoChopNod template (§ 7) will be used:

SEQ.TIME	180 sec
TEL.CHOP.POSANG	0°
TEL.CHOP.THROW	8''
SEQ.CHOPNOD.DIR	PARALLEL

The wavelength setting INS.GRAT1.WLEN and INS.SLIT1.WIDTH will be adjusted to the science observation.

Important note:

The observatory does **not** provide standard calibrations for VISIR medium and high resolution spectroscopy. Thus for medium and high resolution mode the observer has to supply his own calibration by supplying a calibration OB to each science OB. The observing time needed to execute this calibration is charged to the observer. Ideally, early type stars should be chosen. In particular, for high resolution spectroscopy, asteroids provide mostly featureless spectra on the VISIR spectral range.

For both imaging and spectroscopy, day calibrations of VISIR are performed with an extended source that mimics a black-body with adjustable flux (by regulating its temperature). For most instrument modes, a corresponding flat-field is recorded, which consists of a series of images with different background levels. Exceptions are: SiC in the Intermediate Field and all imaging obtained with the spectroscopy detector (for spectroscopy acquisition). Bad pixels, gain maps and fringing patterns can, in principle, be derived from these flat-fields. However, at the moment, the scientific value of the application of these corrections is not established. These day calibrations are supplied to the user

on an experimental basis and may be discontinued with no previous notice.

5.8 OBs Classification

The sky transparency constraints used at Paranal are: photometric (PHO), clear (CLR), thin (THN), and thick (THK). They mostly refer to the optical band and their translation to the IR domain, and specially to the MIR, is not obvious. The following scheme is applied for VISIR. OBs requiring PHO conditions will be executed and classified as A if the sensitivity in the corresponding band is equal or better than the nominal median value and if the conversion factor is constant within 10%. Refer to the web page <http://www.eso.org/instruments/visir/inst/> to know the values of nominal sensitivities in each mode. OBs requiring CLR, THN and THK conditions will be executed and classified as A when the sensitivity is respectively within 20%, 30% and 50% the nominal values.

5.9 Known problems

The cosmetic quality of the AQUARIUS detector is very good. However, this and eventual other problems (e.g. decreased image quality, bad residuals, stripes etc) still need to be investigated.

6 VISIR data

6.1 Data format

One FITS file is saved for each telescope nodding position. This file is a data cube and contains for each chopping cycle:

1. each half cycle frame of the on-source position (A) of the chopper,
2. the average of the current and all previous(A-B) chopped frames,

In addition, the last plane of the cube contains the average of all chopped frames.

In Burst mode a number of FITS files is saved. Each file is a data cube containing up to 1500 elementary frames. The total number of files is such that it sums up the total integration time requested. For the default value of the rotator angle (0°), images are oriented North up and East left. Spectroscopic data are aligned horizontally in the spatial and vertically in the dispersion direction (cf. Fig.??). For the LR and MR modes, the short wavelength appear at the top of the frames. For the HR and HRX modes, the short wavelength is at the top of the frame if the side *B* of the dual-grating is used, and at the bottom of the frame of the side *A* is used.

6.2 Pipeline

The VISIR pipeline has been developed by ESO/DMD and uses the ESO/CPL library. The main observation templates are supported by the pipeline reductions. Raw images of imaging and spectroscopic observations are recombined. Spectra are extracted and calibrated in wavelength (§ 6.3) for all spectroscopic modes in low-, medium-, and high-resolution. Sensitivity estimates based on standard star observations are provided both in imaging and spectroscopy (§ 5.7). The public release of the VISIR pipeline is accessible at: <http://www.eso.org/sci/software/pipelines/>. The pipeline currently supports the following templates :

- VISIR_img_obs_AutoChopNod

- VISIR_spec_obs_LRAutoChopNod
- VISIR_spec_obs_MRAutoChopNod
- VISIR_spec_obs_HRAutoChopNod
- VISIR_spec_obs_HRXAutoChopNod

In mosaic (or raster) mode (VISIR_img_obs_GenericChopNod) only raw frames are delivered, e.g. mapping reconstruction algorithms are not supported.

6.3 VISIR spectrometer data

Optical distortion correction

Spectra are deformed by optical distortion and slit curvatures. The VISIR spectrograph uses curved slits to cancel the distortion of the pre-slit optics. Thus the slit projected on the sky is straight. There is an additional linear distortion in both dispersion and cross-dispersion direction of the detector. The following algorithm is supported by the pipeline for low and medium resolution mode. Let us define the detector pixels in dispersion direction by x and in cross-dispersion direction by y , respectively :

- The skew angle along x with Φ and along y with Ψ .
- The maximum curvature along x with Δ and along y with ϵ .

Φ is defined positive in clockwise-direction and Ψ counter-clockwise; Δ is positive by increasing x and ϵ by decreasing y , respectively. Measured values of the distortion parameters are in the low and medium resolution mode $\Phi = 1.6^\circ$ and $\Psi = 0.7^\circ$. The curvatures in the low resolution mode are $\epsilon = 1.04$ pixel, $\Delta = 0.08$ pixel and for the medium resolution mode are $\epsilon = 0.26$ pixel, $\Delta = 0.08$ pixel. The center of the lower left of the detector is at (1,1). Therefore, the fix point, which is the detector center, is at (512.2, 512.2) for the $n = 1024$ AQUARIUS pixel array.

The fix point is moved to (1,1) by:

$$f_1(x, y) = \left(x - \frac{n+1}{2}, y - \frac{n+1}{2}\right) \quad (6)$$

and the skew is corrected along the cross-dispersion:

$$f_2(x, y) = (x + y \cdot \tan(\Psi), y) \quad (7)$$

and along the dispersion direction:

$$f_3(x, y) = (x, y + x \cdot \tan(\Phi)) \quad (8)$$

The curvature is a segment of a circle with radius, R in x -direction given by: $n = 2 \sqrt{\epsilon \cdot (2R_\epsilon - \epsilon)}$ and in y -direction by: $n = 2 \sqrt{\Delta \cdot (2R_\Delta - \Delta)}$. It is corrected along the cross-dispersion:

$$f_4(x, y) = \left(x, y - \text{sign}(\epsilon) \cdot (R_\epsilon - \sqrt{R_\epsilon^2 - x^2})\right) \quad ; \quad (\epsilon \neq 0) \quad (9)$$

and along the dispersion:

$$f_5(x, y) = \left(x + \text{sign}(\Delta) \cdot (R_\Delta - \sqrt{R_\Delta^2 - y^2}), y\right) \quad ; \quad (\Delta \neq 0) \quad (10)$$

Finally, the origin of the coordinate system is moved back from the fix point to (1,1):

$$f_6(x, y) = \left(x + \frac{n+1}{2}, y + \frac{n+1}{2}\right) \quad (11)$$

Spectral extraction is similar to the TIMMI2 pipeline and described by Siebenmorgen et al. 2004, AA 414, 123.

Wavelength calibration

A first order wavelength calibration is given by the optical model of the instrument. Its precision is about ± 10 pixels for the low and medium resolution mode and ± 15 pixels for the high resolution mode. The wavelength calibration can be refined by using Fabry-Perot Etalons plates or atmospheric lines. In the VISIR FITS file, chopper half-cycle frames, which are dominated by sky emission lines, are stored (§ 6.1). They can be used to fine-tune the wavelength calibration to sub-pixel precision by comparison with a model of the atmospheric lines. This method is used by the pipeline. More specifically, the zero-point of the wavelength calibration is obtained by cross-correlating the observed sky spectrum with a HITRAN model of the sky emission lines.

The chopped frames cannot be used for calibration with atmospheric lines because the chopping process results in a near perfect cancelation of sky lines.

Atmosphere absorption correction

The atmosphere does not uniformly absorb the MIR radiation (§ 3.1). At some wavelengths it is completely transparent, at others partly or completely opaque. Differential absorption is often corrected by dividing the extracted spectrum by a reference spectrum. This procedure may cause numerical instabilities at wavelengths close to strong sky lines that might amplify the noise.

Photometry

Spectro-photometric calibration of low and medium resolution spectra can be achieved with the MIR standard star list provided by the Observatory (see § 5.7). For high-resolution spectroscopy only calibrators known with high precision, such as, A stars or asteroids, should be considered. However, even early A stars are known to have some hydrogen absorption lines in the N and Q band.

7 VISIR templates description

7.1 Acquisition

Each OB needs to start with an acquisition template, they are described in § 5.3.

7.2 Observing with the imager

VISIR_img_obs_AutoChopNod

This template permits observing a source in imaging configuration with various sub-settings. The observer must specify filter, pixel scale, chopper throw, which is in the range of 8'' to 30''. The keyword `SEQ.CHOPNOD.DIR` is set to `PARALLEL` or `PERPENDICULAR`, which results in images as shown in Fig. 14. `PARALLEL` considers an equal nodding and chopping amplitude which are both in parallel direction. It is recommended for faint, extended sources, for which the spatial resolution is not so crucial. `PERPENDICULAR` considers an equal nodding and chopping amplitude; however in perpendicular direction. Note that while the telescope offset is in positive (East) direction, the resulting image on the detector will move to the West. This technique is recommended for point or relatively small extended (< 5'') sources (Fig. 4).

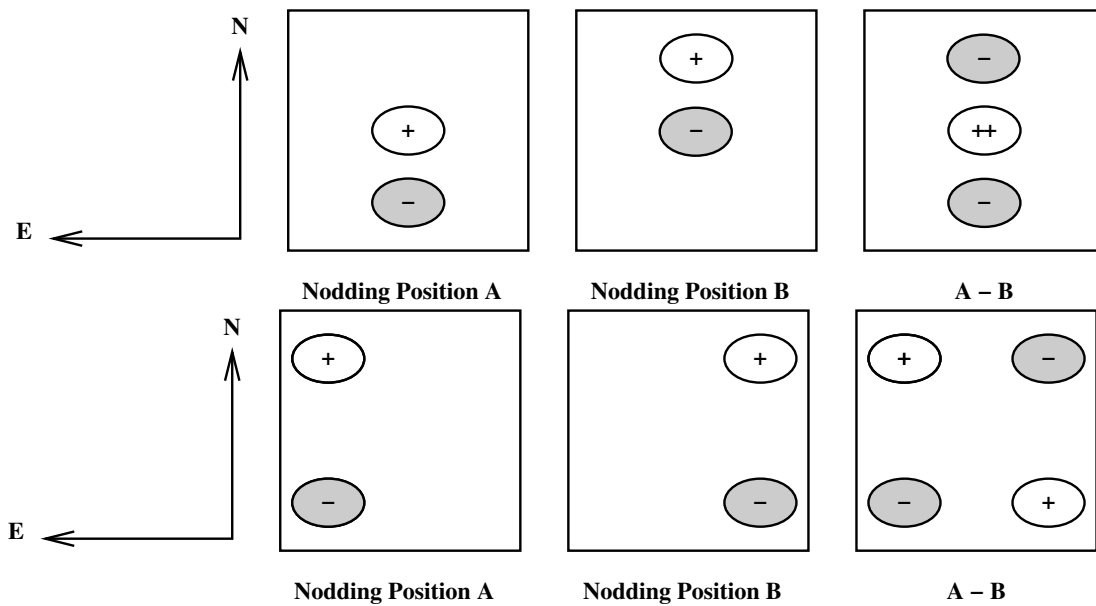

Figure 14: Schematic drawing of the content of a frame obtained with `TEL.ROT.OFFANGLE = TEL.CHOP.POSANG = 0` and `SEQ.CHOPNOD.DIR = PARALLEL` (top) and `SEQ.CHOPNOD.DIR=PERPENDICULAR` (bottom). In the individual nodding positions, the positive beams correspond to the chopper position A and the negative beams to the chopper position B. Note that the default pointing position of the telescope corresponds to the center of the detector. Within the accuracy of the telescope pointing, this location matches the nodding position A, chopper position A if `SEQ.CHOPNOD.DIR = PARALLEL`.

The keywords `SEQ.JITTER.WIDTH` allows chopping and nodding with random offsets so that a jitter pattern is performed. This technique allows to reconstruct bad pixels. For `SEQ.JITTER.WIDTH = 0` no jitter is performed and the resulting image depends on the setting of `SEQ.CHOPNOD.DIR`. The chopping period is set by the system and the nodding period is fixed to 90 s. The number of nodding cycles N_{cycl_nod} is computed according to the total observation time (§ 4.5).

VISIR_img_obs_GenericChopNod

This imaging template enhances the flexibility of nodding offsets, and allows the user to specify them in a list of relative offset positions. In the most simple application, only one offset position is specified. This allows to record nodding pairs, i.e. cycle of on-off observations, using a flexible offset position. Additional jitter offsets can be specified. More than one entry in the offset list results in a freely programmable pattern of nodding pairs. Note that the integration time, SEQ.TIME, specified refers to only one nodding pair. The total observing time is given by the product of SEQ.NOFF \times SEQ.TIME. The offset positions are calculated as the cumulative sum of offsets, i.e. are defined relative to the previous offset positions. Note that the telescope always returns to the first (reference) position, when specifying a list of offsets. This mode can be exploited to perform mosaic or raster imaging. The first reference position can then be considered as a sky observation while the offsets refer to object positions. It is recommended to offset to positions that result in observations of overlapping fields, which enhances the redundancy after image reconstruction.

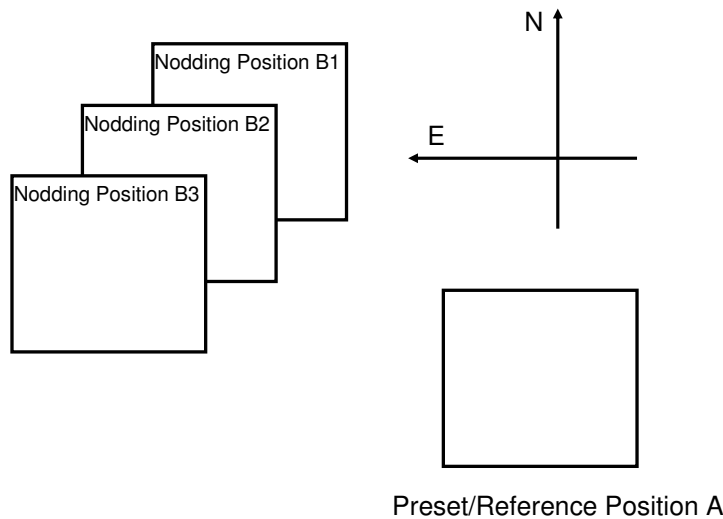

Figure 15: Illustration of generating raster maps with VISIR_img_obs_GenericChopNod.

An illustration of generating an raster map can be found in Fig. 15. The following parameters correspond to this setting:

```
SEQ.NOFF          3
SEQ.OFFSET1.LIST  30 10 10
SEQ.OFFSET2.LIST  30 -10 -10
SEQ.OFFSET.COORDS SKY
```

Note that depending on choice of the integration time SEQ.TIME, several nodding cycles might result, e.g. pattern like AB1B1AAB1B1A..AB2B2AAB2B2A..AB3B3AAB3B3A.

Currently, images obtained with the VISIR_img_obs_GenericChopNod are not reduced by the ESO VISIR pipeline.

Pre-imaging observations: Since Period 76, the observatory supports a fast data release for VISIR pre-imaging observations. Pre-imaging images must be obtained either with the VISIR_img_obs_AutoChopNod or VISIR_img_obs_GenericChopNod templates. The SEQ.CATG keyword must be set to PRE-IMAGE. In addition, the name of the OB must start with the prefix PRE.

VISIR_img_obs_BurstAutoChopNod

The observations in burst mode are analogous to the observations with the template VISIR_img_obs_AutoChopNod but single elementary frames are saved. These can be single DIT frames or the average of a number NDIT of DIT frames. The minimum total integration time is 2 minutes and the total integration time must be a multiple of this value. NDIT can assume values from 1 to 10.

7.3 Observing with the spectrometer

Conceptually the same observing techniques applies for spectroscopy as well as for imaging. The default slit orientation is in North-South direction. The length of the slit is selected by the keyword INS.SLIT1.TYPE: only for cross-dispersed, high-resolution, observations SHORT must be used, otherwise LONG is the default setting.

A preferred observing strategy is called "nodding on the slit", where the chopping and nodding amplitudes are small (SEQ.CHOPNOD.DIR = PARALLEL). Note that "nodding on the slit" requires to set the telescope rotator offset angle *and* the M2 chopping position angle to the same value (which is, in general, different from 0). This is useful to acquire two targets simultaneously in the slit.

The keyword SEQ.JITTER.WIDTH allows to apply random offsets *along the slit*.

More complex source geometries might require larger amplitudes, and/or SEQ.CHOPNOD.DIR = PERPENDICULAR in order to avoid self-cancellation.

Low and medium resolution

Templates for low and medium resolution spectroscopy are:

VISIR_spec_obs_LRAutoChopNod and VISIR_spec_obs_MRAutoChopNod, respectively. Observing parameters are: total integration time (SEQ.TIME), central wavelength (INS.GRAT1.WLEN), the slit width INS.SLIT1.WIDTH and SEQ.CHOPNOD.DIR (§ 7.2).

High resolution: long-slit mode

Template for high resolution spectroscopy is VISIR_spc_obs_HRAutoChopNod. Three order sorting filter at 8.02, 12.81 and 17.03 μm , INS.FILT2.NAME = ([H2_S4],[Ne II],[H2_S1]) are available. See Table 6 for the corresponding list of offered central wavelengths. Other observing parameters are: total integration time (SEQ.TIME), central wavelength (INS.GRAT1.WLEN), the slit width (INS.SLIT1.WIDTH) and SEQ.CHOPNOD.DIR (§ 7.2).

High resolution: cross-dispersed mode

VISIR_spc_obs_HRXAutoChopNod is functionally similar to VISIR_spc_obs_HRAutoChopNod, but uses a grism for cross-dispersion and order-separation. See Table 6 for a list of offered wavelengths. Note that the effective length of the spectrograph slit is limited to $\sim 4''$. Total integration time (SEQ.TIME), the slit width (INS.SLIT1.WIDTH) and SEQ.CHOPNOD.DIR are specified as usual (§ 7.2).

7.4 Calibration

Specific templates exist for the observations of photometric and spectro-photometric standard stars. They offer the same functionality as the corresponding science templates, but allow to monitor the sensitivity and image quality by observing calibration standard stars.

Their use is recommended to be properly recognized by the VISIR pipeline.

8 Checklist

This section provides a number of advice regarding the preparation of the proposal.

8.1 Phase 1

It is very important that the time justification (Box 9) of the proposal contains enough information so that its feasibility can be correctly assessed. The following points must be respected:

1. the expected S/N for each object and modes must be given;
2. in particular for extended sources: does the reported S/N refer to an area of 1 arcsec^2 (as given by the imaging ETC), to an extent of 1 arcsec in the spatial direction (as given by the spectroscopy ETC) or to the whole spatial extent of the object?
3. in spectroscopy, does the S/N refer to one pixel in the dispersion direction (as given by the ETC) or to one resolution element?
4. in case of large throw, does the S/N take into account the fact that some beams would fall outside the detector?
5. does the overhead calculation include the time required for each preset, given that OBs should in general not be longer than 1 hour?
6. is there a guide star brighter than $V = 13.5$ mag within a radius of 7.5 arcmin around the object?

8.2 Phase 2

1. *Acquisition:* Are the coordinates accurate in the equinox J2000.0 reference frame? For high-proper motion objects, are they valid for the epoch of the observations? For solar system objects, are they in the topocentric, ICRF or FK5, J2000.0 reference frame at the epoch of the observations?
2. *Acquisition:* If the VISIR_img_acq_Preset is used and the following templates have SEQ.CHOPNOD.DIR = PERPENDICULAR, the target will appear at the center of the detector by default, with the risk of losing 3 beams that would appear outside of the field. Either slightly change the coordinates of TEL.TARG.ALPHA and TEL.TARG.DELTA, or use TEL.TARG.OFFSETALPHA and TEL.TARG.OFFSETDELTA. See § 5.3.
3. *Acquisition:* It is strongly recommended that a same guide star be selected and inserted in the acquisition template for all OBs of a same field, in particular if
 - relatively good astrometric accuracy is required;
 - the object is faint or diffuse and unlikely to be visible on short exposures;
 - the object appears in the field of a bright nebula that saturates the digitized sky survey (DSS) used by the telescope and instrument operator;

The guidecam tool (see <http://www.eso.org/instruments/visir/doc>) can help in selecting appropriate guide stars.

4. *Calibrations:* For calibration OBs, use the appropriate VISIR_img_cal_AutoChopNod or VISIR_spc_cal_LR/MR/HR/HRXAutoChopNod templates.
5. *Position angle:* If the observations must be carried out at a position angle different from 0, check § 5.2.1 and § 5.2.2. In particular, it is useful to clearly indicate in the README file if TEL.CHOP.POSANG is not equal to TEL.ROT.OFFANGLE to warn the instrument operator about the non-standard configuration. In particular, in spectroscopy, TEL.CHOP.POSANG must be equal to TEL.ROT.OFFANGLE in order to have the 3 beams along the slit.

9 Appendix: VISIR template parameters

VISIR_img_acq_MoveToPixel.tsf		
<i>To be specified:</i>		
Parameter	Range (Default)	Label
INS.FILT1.NAME	K-BAND SIC PAH1 ARIII SIV_1 SIV SIV_2 PAH2 PAH2_2 NEII_1 NEII NEII_2 Q1 Q2 Q3 (<i>NODE- FAULT</i>)	Imager Filter
INS.PFOV	0.045 0.076 (<i>0.076</i>)	Imager pixel scale
SEQ.CHOPNOD.DIR	PARALLEL PERPENDICU- LAR (<i>PARALLEL</i>)	Relative Chop/Nod Direction
SEQ.TIME	30..3600 (<i>NODEFAULT</i>)	Total integration time (sec)
TEL.AG.GUIDESTAR	CATALOGUE SETUPFILE NONE (<i>CATALOGUE</i>)	Get Guide Star from
TEL.CHOP.POSANG	0..359 (<i>0</i>)	Chopping Position Angle (deg)
TEL.CHOP.THROW	8..30 (<i>8</i>)	Chopping Amplitude (arcsec)
TEL.GS1.ALPHA	ra ()	Guide star RA
TEL.GS1.DELTA	dec ()	Guide star DEC
TEL.ROT.OFFANGLE	0..359 (<i>0.0</i>)	Rotator on Sky (=PA on Sky)
TEL.TARG.ADDVELALPHA	(<i>0.0</i>)	RA additional tracking velocity ("/sec)
TEL.TARG.ADDVELDELTA	(<i>0.0</i>)	DEC additional tracking velocity ("/sec)
TEL.TARG.ALPHA	ra ()	
TEL.TARG.DELTA	dec ()	
TEL.TARG.EQUINOX	(<i>2000.0</i>)	
TEL.TARG.OFFSETALPHA	(<i>0.0</i>)	RA blind offset
TEL.TARG.OFFSETDELTA	(<i>0.0</i>)	DEC blind offset
VISIR_img_acq_Preset.tsf		
<i>To be specified:</i>		
Parameter	Range (Default)	Label
TEL.AG.GUIDESTAR	CATALOGUE SETUPFILE NONE (<i>CATALOGUE</i>)	Get Guide Star from
TEL.GS1.ALPHA	ra ()	Guide star RA
TEL.GS1.DELTA	dec ()	Guide star DEC
TEL.ROT.OFFANGLE	0..359 (<i>0.0</i>)	Rotator on Sky (=PA on Sky)
TEL.TARG.ADDVELALPHA	(<i>0.0</i>)	RA additional tracking velocity ("/sec)
TEL.TARG.ADDVELDELTA	(<i>0.0</i>)	DEC additional tracking velocity ("/sec)
TEL.TARG.ALPHA	ra ()	
TEL.TARG.DELTA	dec ()	
TEL.TARG.EQUINOX	(<i>2000.0</i>)	
TEL.TARG.OFFSETALPHA	0.0	RA blind offset
TEL.TARG.OFFSETDELTA	0.0	DEC blind offset

VISIR_spec_acq_MoveToSlit.tsf

To be specified:

Parameter	Range (<i>Default</i>)	Label
INS.FILT2.NAME	N_SW N_LW ARIII NEII_1 NEII_2 (<i>NODEFAULT</i>)	Acquisition Filter
INS.SLIT1.TYPE	LONG SHORT (<i>LONG</i>)	Spectrometer Slit Type (long or short)
INS.SLIT1.WIDTH	0.40 0.75 1.00 (<i>NODEFAULT</i>)	Spectrometer Slit Width (arcsec)
SEQ.CHOPNOD.DIR	PARALLEL PERPENDICULAR (<i>PARALLEL</i>)	Relative Chop/Nod Direction
SEQ.TIME	30..3600 (<i>NODEFAULT</i>)	Total integration time (sec)
TEL.AG.GUIDESTAR	CATALOGUE SETUPFILE NONE (<i>CATALOGUE</i>)	Get Guide Star from
TEL.CHOP.POSANG	0..359 (<i>0</i>)	Chopping Position Angle (deg)
TEL.CHOP.THROW	8..30 (<i>8</i>)	Chopping Amplitude (arcsec)
TEL.GS1.ALPHA	ra ()	Guide star RA
TEL.GS1.DELTA	dec ()	Guide star DEC
TEL.ROT.OFFANGLE	0..359 (<i>0.0</i>)	Rotator on Sky (=PA on Sky)
TEL.TARG.ADDVELALPHA	(<i>0.0</i>)	RA additional tracking velocity ("/sec)
TEL.TARG.ADDVELDELTA	(<i>0.0</i>)	DEC additional tracking velocity ("/sec)
TEL.TARG.ALPHA	ra ()	
TEL.TARG.DELTA	dec ()	
TEL.TARG.EQUINOX	(<i>2000.0</i>)	
TEL.TARG.OFFSETALPHA	(<i>0.0</i>)	RA blind offset
TEL.TARG.OFFSETDELTA	(<i>0.0</i>)	DEC blind offset

VISIR_spec_acq_ImgMoveToSlit.tsf

To be specified:

Parameter	Range (<i>Default</i>)	Label
INS.FILT1.NAME	K-BAND SIC PAH1 ARIII SIV_1 SIV SIV_2 PAH2 PAH2_2 NEII_1 NEII NEII_2 Q1 Q2 Q3 (<i>NODE- FAULT</i>)	Acquisition Filter for the im- ager detector
INS.FILT2.NAME	N_SW N_LW ARIII NEII_1 NEII_2 (<i>NODEFAULT</i>)	Acquisition Filter for the spectroscopy detector
INS.SLIT1.TYPE	LONG SHORT (<i>LONG</i>)	Spectrometer Slit Type (long or short)
INS.SLIT1.WIDTH	0.40 0.75 1.00 (<i>NODE- FAULT</i>)	Spectrometer Slit Width (arc- sec)
SEQ.CHOPNOD.DIR	PARALLEL PERPENDICU- LAR (<i>PARALLEL</i>)	Relative Chop/Nod Direction
SEQ.TIME	30..3600 (<i>NODEFAULT</i>)	Total integration time (sec)
TEL.AG.GUIDESTAR	CATALOGUE SETUPFILE NONE (<i>CATALOGUE</i>)	Get Guide Star from
TEL.CHOP.POSANG	0..359 (<i>0</i>)	Chopping Position Angle (deg)
TEL.CHOP.THROW	8..30 (<i>8</i>)	Chopping Amplitude (arcsec)
TEL.GS1.ALPHA	ra (<i>)</i>	Guide star RA
TEL.GS1.DELTA	dec (<i>)</i>	Guide star DEC
TEL.ROT.OFFANGLE	0..359 (<i>0.0</i>)	Rotator on Sky (=PA on Sky)
TEL.TARG.ADDVELALPHA	(<i>0.0</i>)	RA additional tracking veloci- ty ("/sec)
TEL.TARG.ADDVELDELTA	(<i>0.0</i>)	DEC additional tracking ve- locity ("/sec)
TEL.TARG.ALPHA	ra (<i>)</i>	
TEL.TARG.DELTA	dec (<i>)</i>	
TEL.TARG.EQUINOX	(<i>2000.0</i>)	
TEL.TARG.OFFSETALPHA	(<i>0.0</i>)	RA blind offset
TEL.TARG.OFFSETDELTA	(<i>0.0</i>)	DEC blind offset

9.1 Observation

VISIR_img_obs_AutoChopNod.tsf		
<i>To be specified:</i>		
Parameter	Range (Default)	Label
INS.FILT1.NAME	SIC PAH1 ARIII SIV_1 SIV SIV_2 PAH2 PAH2_2 NEII_1 NEII NEII_2 Q1 Q2 Q3 (NODEFAULT)	Imager Filter
INS.PFOV	0.045 0.076 (0.076)	Imager pixel scale
SEQ.CATG	PRE-IMAGE SCIENCE (SCIENCE)	Observation Category
SEQ.CHOPNOD.DIR	PARALLEL PERPENDICU- LAR (PARALLEL)	Relative Chop/Nod Direction
SEQ.JITTER.WIDTH	0..10 (0)	Random Jitter Width (arcsec)
SEQ.TIME	180..3600 (NODEFAULT)	Total integration time (sec)
TEL.CHOP.POSANG	0..359 (0)	Chopping Position Angle (deg)
TEL.CHOP.THROW	8..30 (8)	Chopping Amplitude (arcsec)
VISIR_img_obs_GenericChopNod.tsf		
<i>To be specified:</i>		
Parameter	Range (Default)	Label
INS.FILT1.NAME	SIC PAH1 ARIII SIV_1 SIV SIV_2 PAH2 PAH2_2 NEII_1 NEII NEII_2 Q1 Q2 Q3 (NODEFAULT)	Imager Filter
INS.PFOV	0.045 0.076 (0.076)	Imager pixel scale
SEQ.CATG	PRE-IMAGE SCIENCE (SCIENCE)	Observation Category
SEQ.NOFF	1..100 (NODEFAULT)	Number of offset positions
SEQ.OFFSET.COORDS	SKY DETECTOR (NODE- FAULT)	Offset coordinates
SEQ.OFFSET1.LIST	(NODEFAULT)	List of offsets in RA or X
SEQ.OFFSET2.LIST	(NODEFAULT)	List of offsets in DEC or Y
SEQ.TIME	180..3600 (NODEFAULT)	Total integration time (sec)
TEL.CHOP.POSANG	0..359 (0)	Chopping Position Angle (deg)
TEL.CHOP.THROW	8..30 (10)	Chopping Amplitude (arcsec)

VISIR_spec_obs_LRAutoChopNod.tsf

To be specified:

Parameter	Range (Default)	Label
INS.GRAT1.WLEN	8.1 8.5 8.8 9.8 11.4 12.2 12.4 (<i>NODEFAULT</i>)	Spectrometer Wavelength (microns)
SEQ.CHOPNOD.DIR	PARALLEL PERPENDICU- LAR (<i>PARALLEL</i>)	Relative Chop/Nod Direction
SEQ.JITTER.WIDTH	0..10 (0)	Random Jitter Width (arcsec)
SEQ.TIME	180..3600 (<i>NODEFAULT</i>)	Total integration time (sec)
TEL.CHOP.POSANG	0..359 (0)	Chopping Position Angle (deg)
TEL.CHOP.THROW	8..30 (8)	Chopping Amplitude (arcsec)

VISIR_spec_obs_MRAutoChopNod.tsf

To be specified:

Parameter	Range (Default)	Label
INS.GRAT1.WLEN	7.5..28.08 (<i>NODEFAULT</i>)	Spectrometer Wavelength (microns)
SEQ.CHOPNOD.DIR	PARALLEL PERPENDICU- LAR (<i>PARALLEL</i>)	Relative Chop/Nod Direction
SEQ.JITTER.WIDTH	0..10 (0)	Random Jitter Width (arcsec)
SEQ.TIME	180..3600 (<i>NODEFAULT</i>)	Total integration time (sec)
TEL.CHOP.POSANG	0..359 (0)	Chopping Position Angle (deg)
TEL.CHOP.THROW	8..30 (8)	Chopping Amplitude (arcsec)

VISIR_spec_obs_HRAutoChopNod.tsf

To be specified:

Parameter	Range (Default)	Label
INS.FILT2.NAME	NEII_2 H2S_1 H2S_4 (<i>NEII_2</i>)	Spectrometer Filter
INS.GRAT1.WLEN	7.80..19.18 (<i>12.810</i>)	Spectrometer Wavelength (microns)
SEQ.CHOPNOD.DIR	PARALLEL PERPENDICU- LAR (<i>PARALLEL</i>)	Relative Chop/Nod Direction
SEQ.JITTER.WIDTH	0..10 (0)	Random Jitter Width (arcsec)
SEQ.TIME	180..3600 (<i>NODEFAULT</i>)	Total integration time (sec)
TEL.CHOP.POSANG	0..359 (0)	Chopping Position Angle (deg)
TEL.CHOP.THROW	8..30 (8)	Chopping Amplitude (arcsec)

VISIR_spec_obs_HRXAutoChopNod.tsf

<i>To be specified:</i>		
Parameter	Range (<i>Default</i>)	Label
INS.GRAT1.WLEN	7.60..28.08 (<i>NODEFAULT</i>)	Spectrometer Wavelength (microns)
SEQ.CHOPNOD.DIR	PARALLEL PERPENDICULAR (<i>PARALLEL</i>)	Relative Chop/Nod Direction
SEQ.JITTER.WIDTH	0..10 (0)	Random Jitter Width (arcsec)
SEQ.TIME	180..3600 (<i>NODEFAULT</i>)	Total integration time (sec)
TEL.CHOP.POSANG	0..359 (0)	Chopping Position Angle (deg)
TEL.CHOP.THROW	8..30 (8)	Chopping Amplitude (arcsec)

9.2 Calibration

VISIR_img_cal_AutoChopNod.tsf

<i>To be specified:</i>		
Parameter	Range (<i>Default</i>)	Label
INS.FILT1.NAME	SIC PAH1 ARIII SIV_1 SIV SIV_2 PAH2 PAH2_2 NEII_1 NEII NEII_2 Q1 Q2 Q3 (<i>NODEFAULT</i>)	Imager Filter
INS.PFOV	0.045 0.076 (0.076)	Imager pixel scale
SEQ.CHOPNOD.DIR	PARALLEL PERPENDICULAR (<i>PERPENDICULAR</i>)	Relative Chop/Nod Direction
SEQ.JITTER.WIDTH	0..10 (0)	Random Jitter Width (arcsec)
SEQ.TIME	30..3600 (<i>NODEFAULT</i>)	Total integration time (sec)
TEL.CHOP.POSANG	0..359 (0)	Chopping Position Angle (deg)
TEL.CHOP.THROW	8..30 (8)	Chopping Amplitude (arcsec)

VISIR_spec_cal_LRAutoChopNod.tsf

<i>To be specified:</i>		
Parameter	Range (<i>Default</i>)	Label
INS.GRAT1.WLEN	8.1 8.5 8.8 9.8 11.4 12.2 12.4 (<i>NODEFAULT</i>)	Spectrometer Wavelength (microns)
SEQ.CHOPNOD.DIR	PARALLEL PERPENDICULAR (<i>PARALLEL</i>)	Relative Chop/Nod Direction
SEQ.JITTER.WIDTH	0..10 (0)	Random Jitter Width (arcsec)
SEQ.TIME	30..3600 (<i>NODEFAULT</i>)	Total integration time (sec)
TEL.CHOP.POSANG	0..359 (0)	Chopping Position Angle (deg)
TEL.CHOP.THROW	8..30 (8)	Chopping Amplitude (arcsec)

VISIR_spec_cal_MRAutoChopNod.tsf

To be specified:

Parameter	Range (Default)	Label
INS.GRAT1.WLEN	7.5..28.08 (NODEFAULT)	Spectrometer Wavelength (microns)
SEQ.CHOPNOD.DIR	PARALLEL PERPENDICULAR (PARALLEL)	Relative Chop/Nod Direction
SEQ.JITTER.WIDTH	0..10 (0)	Random Jitter Width (arcsec)
SEQ.TIME	30..3600 (NODEFAULT)	Total integration time (sec)
TEL.CHOP.POSANG	0..359 (0)	Chopping Position Angle (deg)
TEL.CHOP.THROW	8..30 (8)	Chopping Amplitude (arcsec)

VISIR_spec_cal_HRAutoChopNod.tsf

To be specified:

Parameter	Range (Default)	Label
INS.FILT2.NAME	NEII_2 H2S_1 H2S_4 (NEII_2)	Spectrometer Filter
INS.GRAT1.WLEN	7.80..19.18 (12.810)	Spectrometer Wavelength (microns)
SEQ.CHOPNOD.DIR	PARALLEL PERPENDICULAR (PARALLEL)	Relative Chop/Nod Direction
SEQ.JITTER.WIDTH	0..10 (0)	Random Jitter Width (arcsec)
SEQ.TIME	30..3600 (NODEFAULT)	Total integration time (sec)
TEL.CHOP.POSANG	0..359 (0)	Chopping Position Angle (deg)
TEL.CHOP.THROW	8..30 (8)	Chopping Amplitude (arcsec)

VISIR_spec_cal_HRXAutoChopNod.tsf

To be specified:

Parameter	Range (Default)	Label
INS.GRAT1.WLEN	7.60..28.08 (NODEFAULT)	Spectrometer Wavelength (microns)
SEQ.CHOPNOD.DIR	PARALLEL PERPENDICULAR (PARALLEL)	Relative Chop/Nod Direction
SEQ.JITTER.WIDTH	0..10 (0)	Random Jitter Width (arcsec)
SEQ.TIME	30..3600 (NODEFAULT)	Total integration time (sec)
TEL.CHOP.POSANG	0..359 (0)	Chopping Position Angle (deg)
TEL.CHOP.THROW	8..30 (8)	Chopping Amplitude (arcsec)

10 Appendix: Filter transmission curves

The filter transmission has been measured using a Fourier Transform Spectrometer, at a temperature of 35 K for filters manufactured by the company READING. Their absolute transmission curves are displayed in Fig. 16. The other filters, manufactured by OCLI, have been measured using the WCU and wavelength scans with the monochromator. Note that for these filters, the transmission curves are normalized to 1, see Fig. 19.

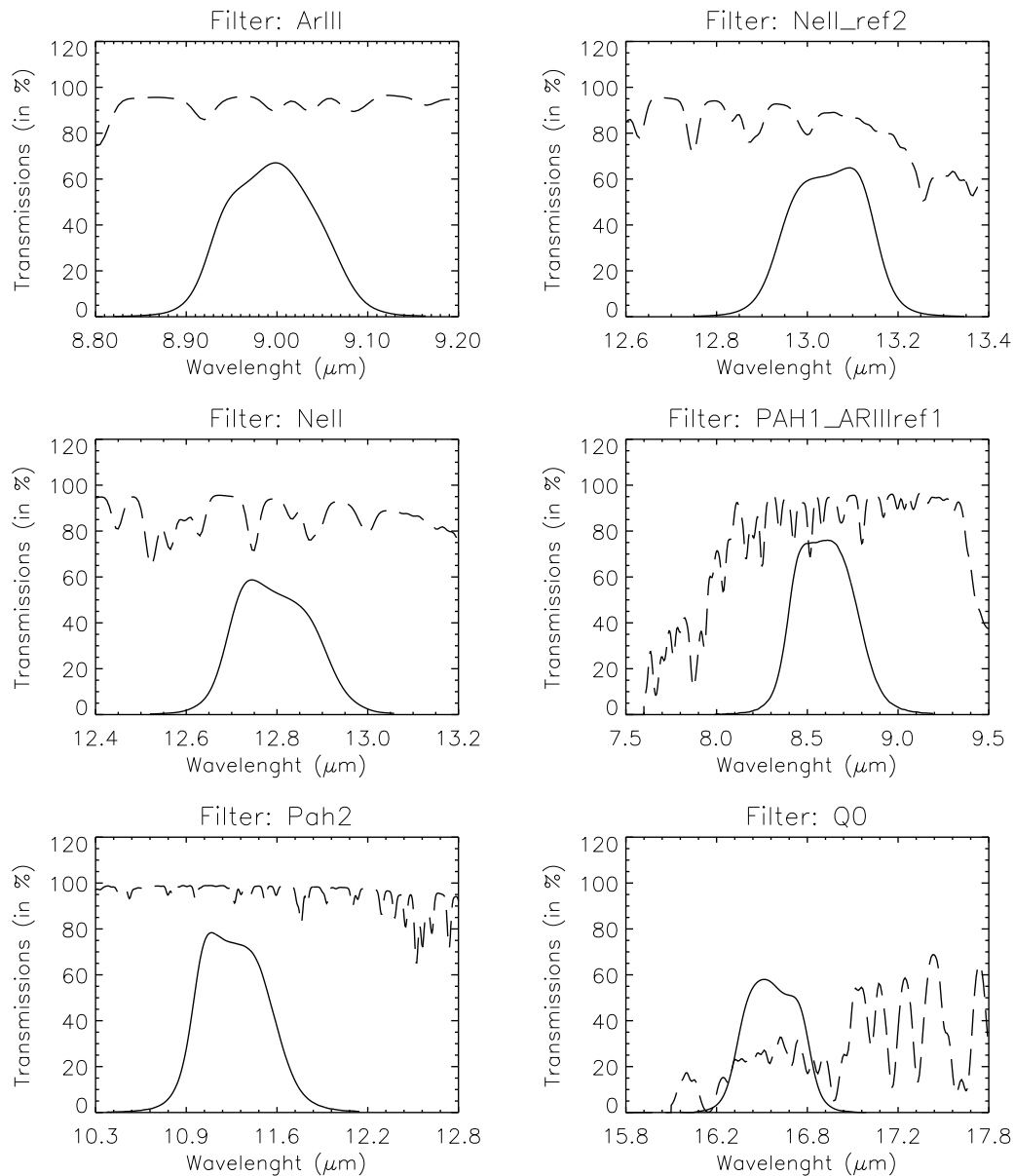

Figure 16: Transmission curves of VISIR imager filters, manufactured by READING. Overplotted (dashed) is the atmospheric transmission at low resolution. The absolute transmission values are given, expressed in percent.

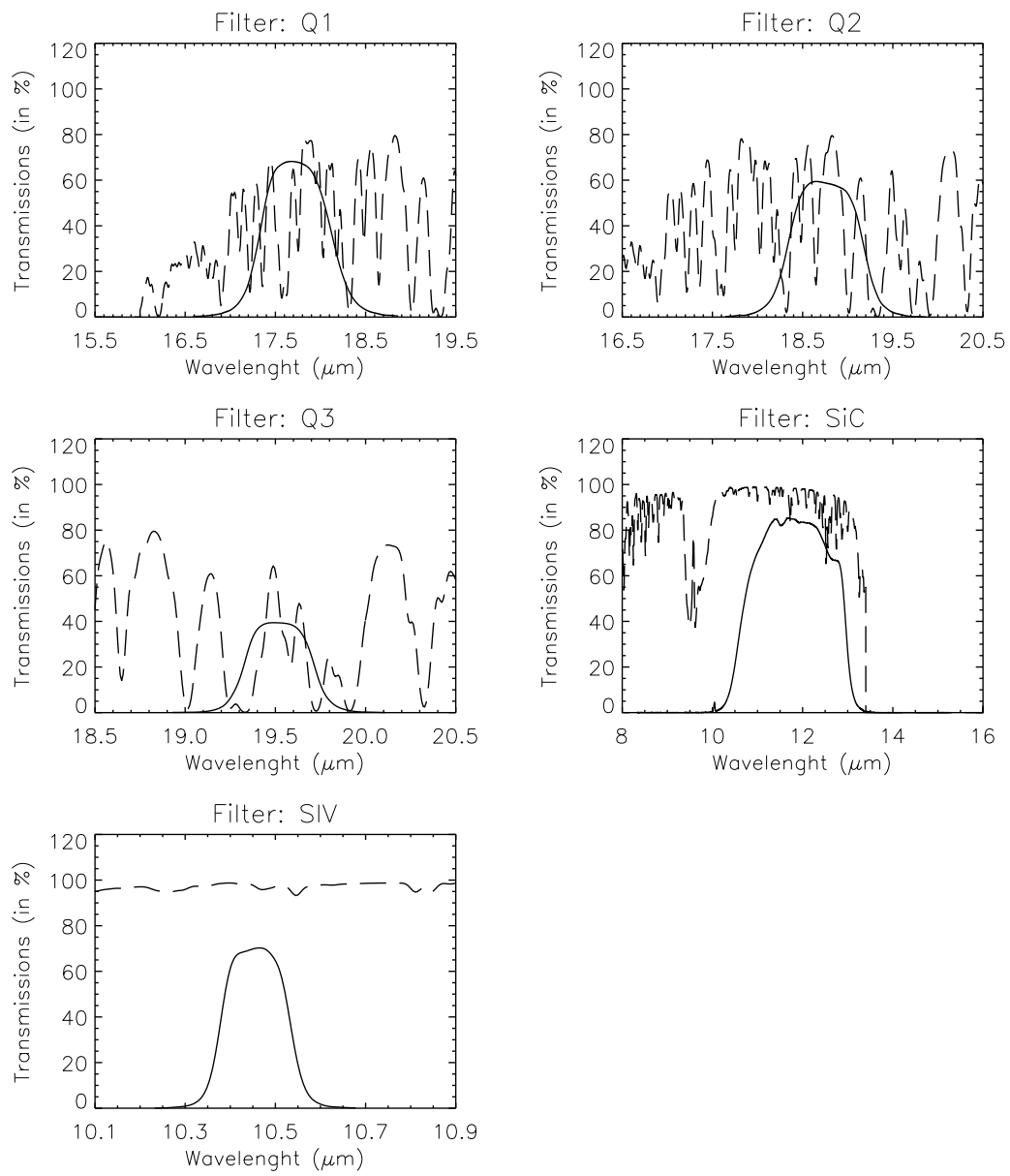

Figure 18: – continued.

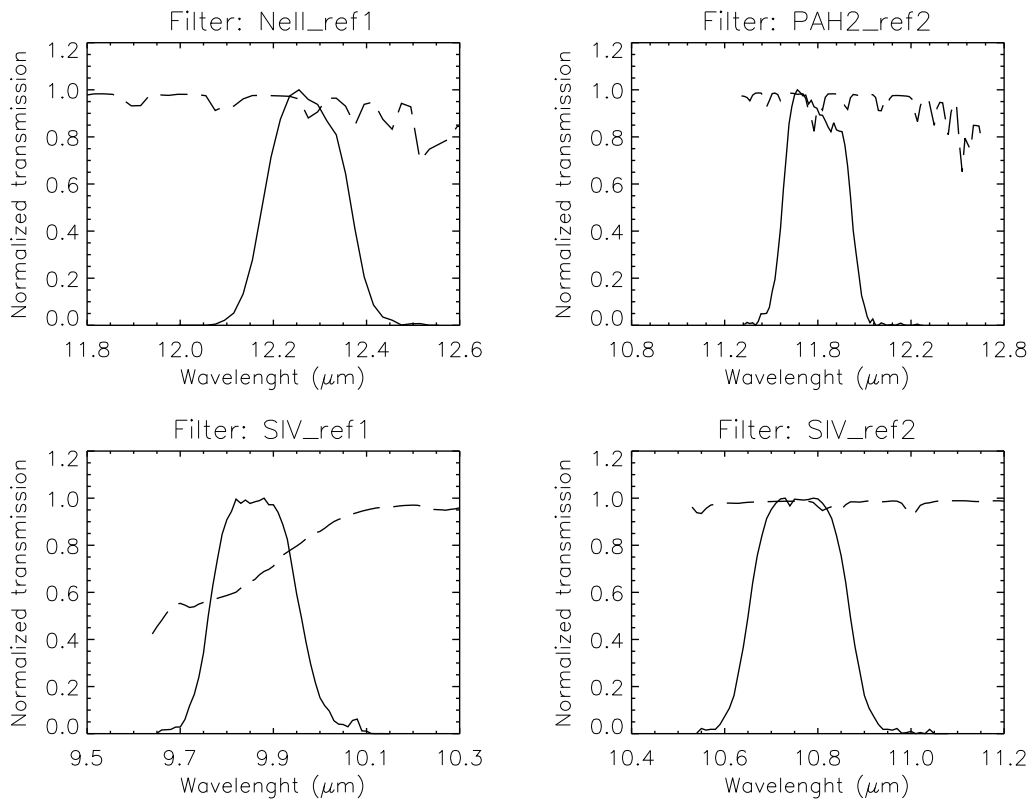

Figure 19: Transmission curves of VISIR imager filters, manufactured by OCLI. Overplotted (dashed) is the atmospheric transmission at low resolution. Only relative transmissions have been determined; their values are normalized so that their peak transmission is equal to 1.

11 Appendix: Observed sensitivities in various spectroscopic settings

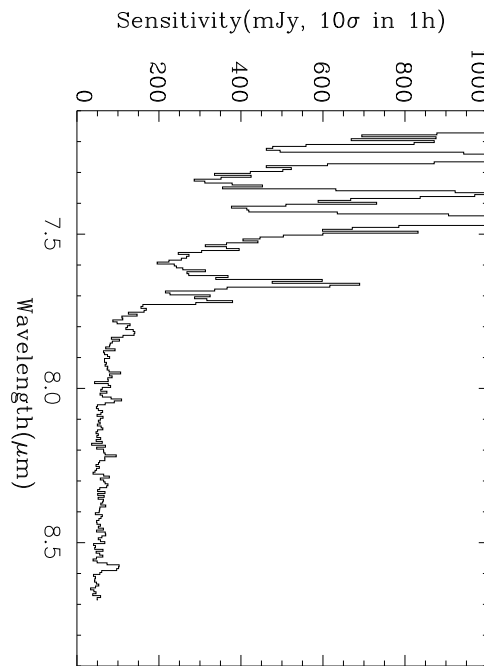
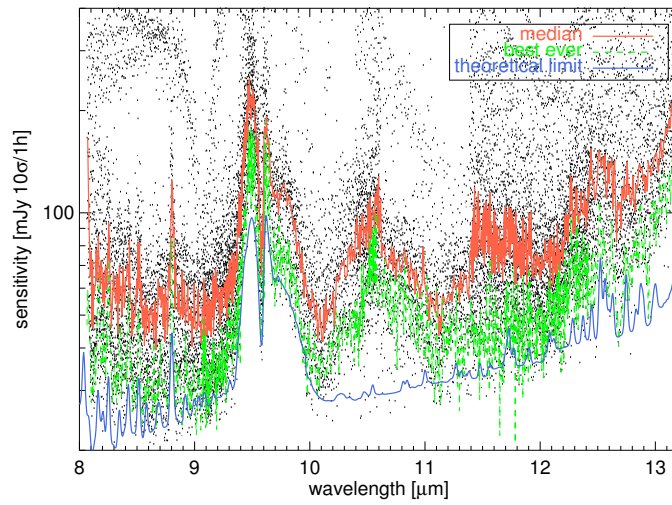
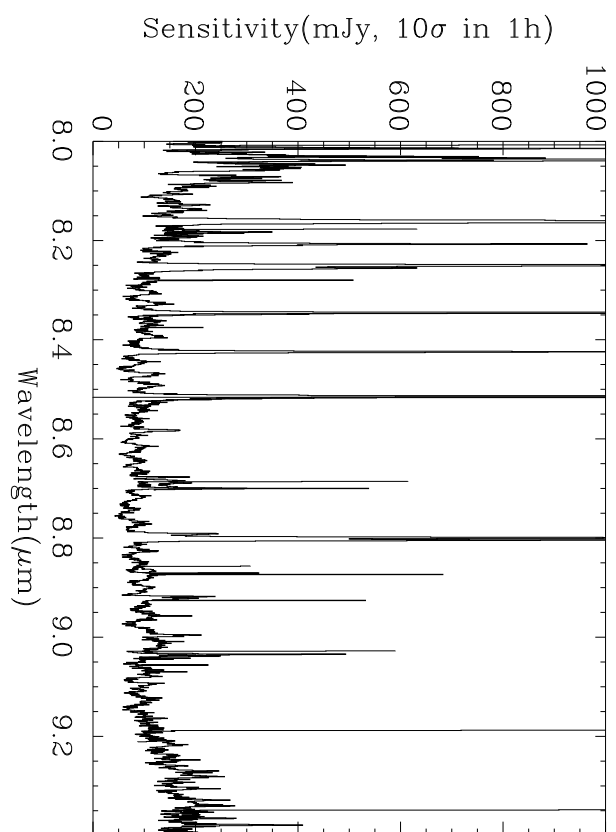
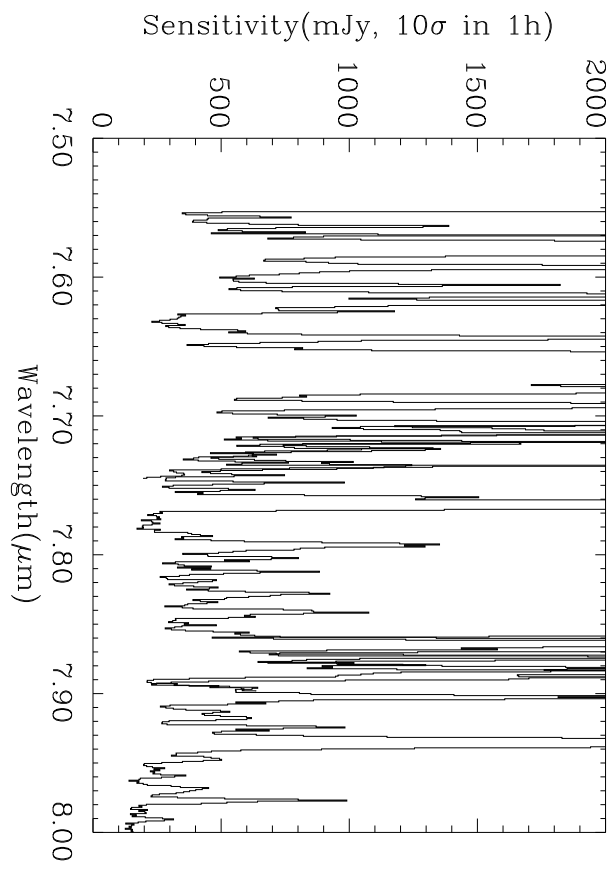

Figure 20: **Measured on the old DRS detector.** Sensitivity as a function of wavelength for low resolution mode. *Top:* Four offered settings of the N-band low-resolution are stitched together. Atmospheric molecular absorption, e.g. at 9.55 , 11.8 and $12.5 \mu\text{m}$, is evident. Note the detector feature at $8.8 \mu\text{m}$. Dots indicate individual observations, full lines represent median and the dashed line the best sensitivities. Theoretical model curves correspond to BLIP. *Bottom:* Sensitivity measured in the bluer setting, centered at $8.1 \mu\text{m}$.



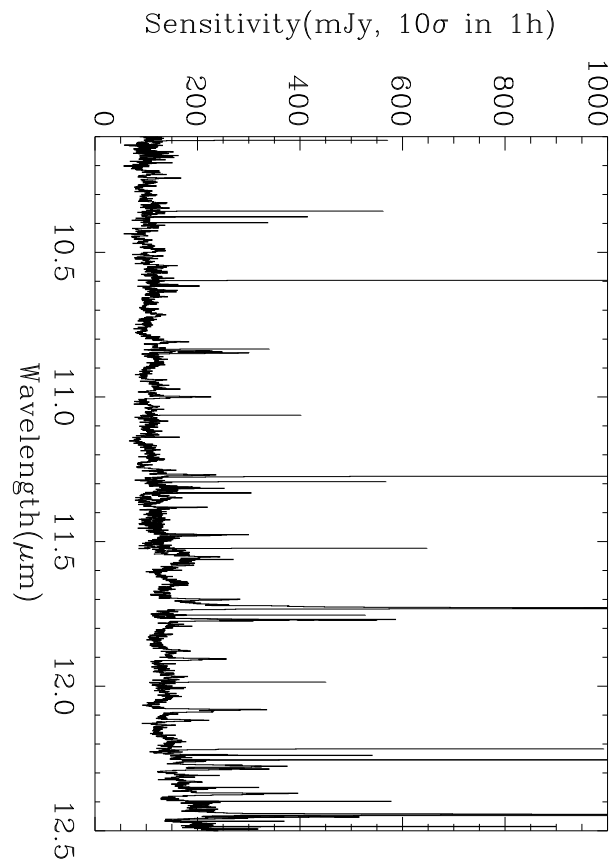

Figure 22: **Measured on the old DRS detector.** Observed sensitivity as a function of wavelength for different settings in the medium resolution mode obtained in very good weather conditions: (II) for $10.1\mu\text{m} < \lambda < 12.5\mu\text{m}$. Offered sensitivity is typically a factor of 2 larger.

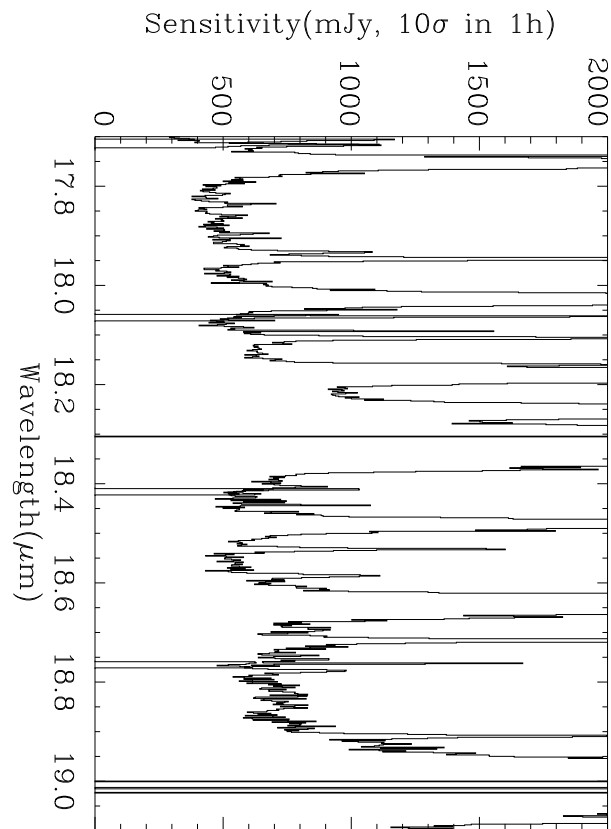

Figure 23: **Measured on the old DRS detector.** Observed sensitivity as a function of wavelength for different settings in the medium resolution mode obtained in very good weather conditions: (III) for $17.7\mu\text{m} < \lambda < 19.1\mu\text{m}$. Offered sensitivity is typically a factor of 2 larger.

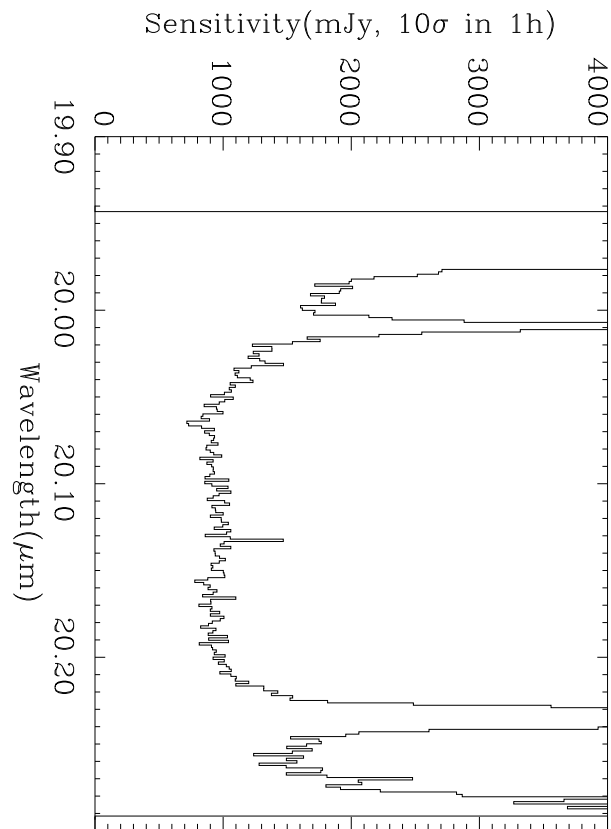

Figure 24: **Measured on the old DRS detector.** Observed sensitivity as a function of wavelength for different settings in the medium resolution mode obtained in very good weather conditions: (IV) for $19.9\mu\text{m} < \lambda < 20.3\mu\text{m}$. Offered sensitivity is typically a factor of 2 larger.

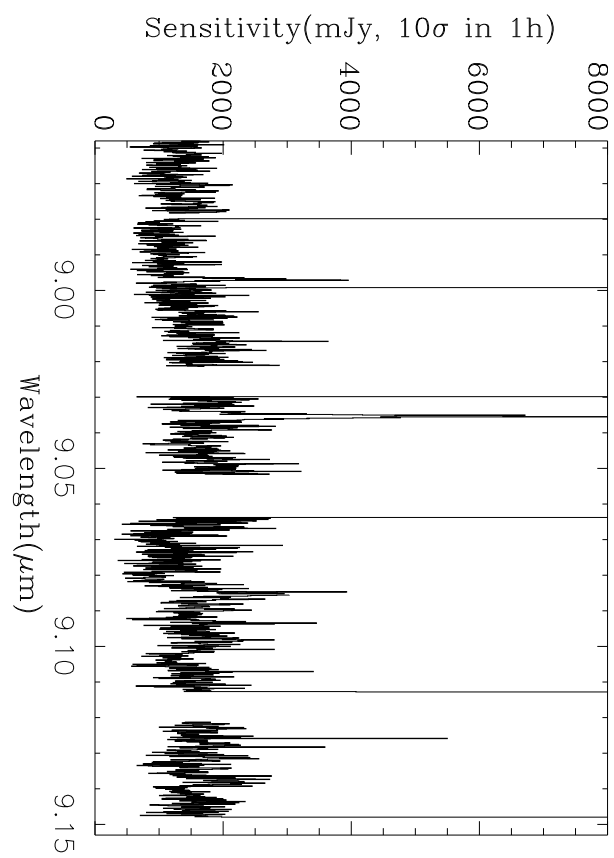

Figure 25: **Measured on the old DRS detector.** Observed sensitivity as a function of wavelength for high resolution mode. Offered sensitivity is typically a factor of 2 larger.

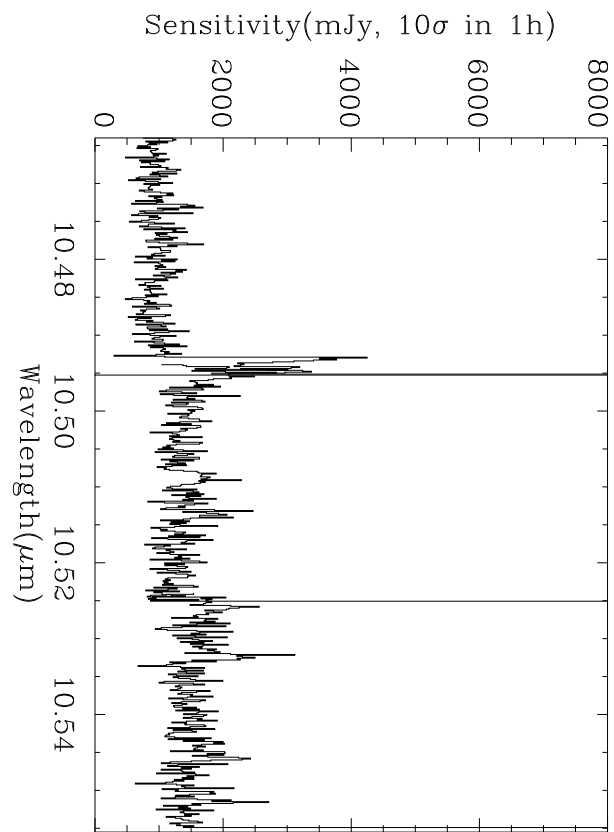

Figure 26: **Measured on the old DRS detector.** Observed sensitivity as a function of wavelength for high resolution mode. Offered sensitivity is typically a factor of 2 larger.

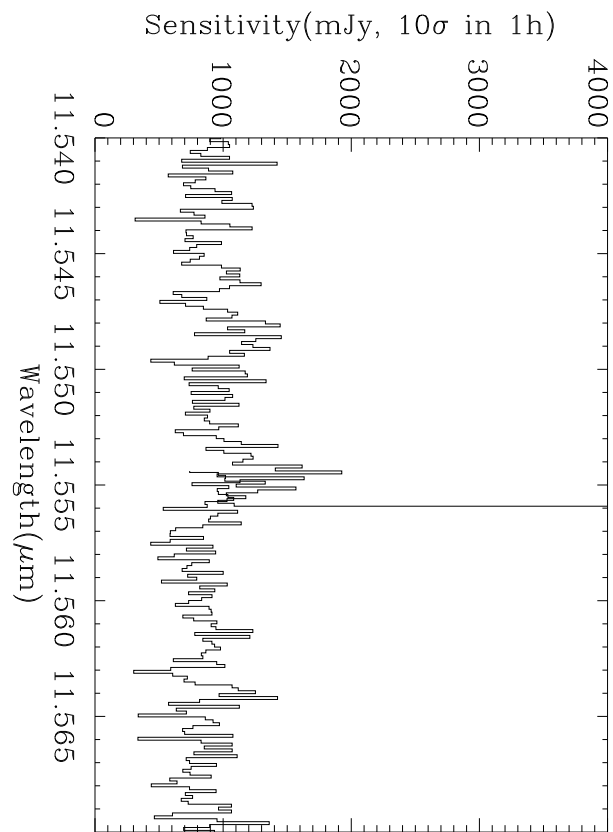

Figure 27: **Measured on the old DRS detector.** Observed sensitivity as a function of wavelength for high resolution mode. Offered sensitivity is typically a factor of 2 larger.

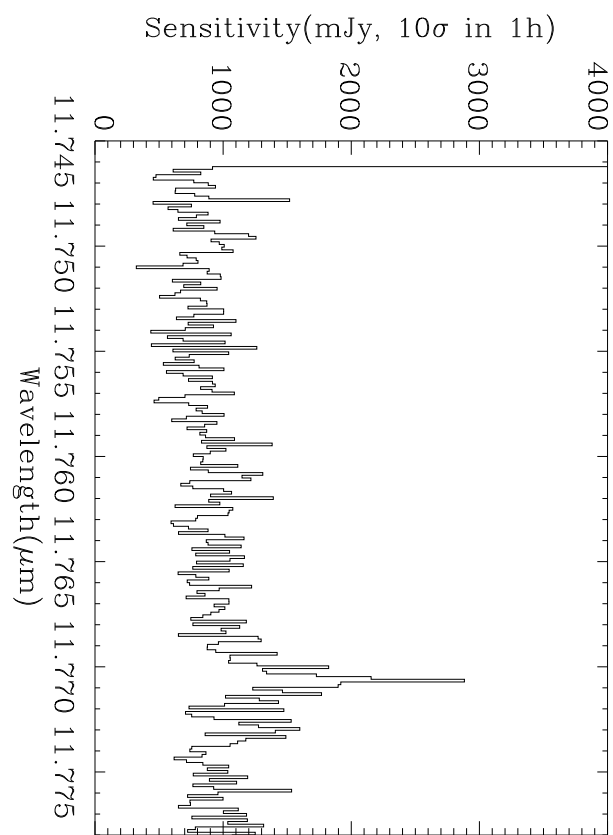

Figure 28: **Measured on the old DRS detector.** Observed sensitivity as a function of wavelength for high resolution mode. Offered sensitivity is typically a factor of 2 larger.

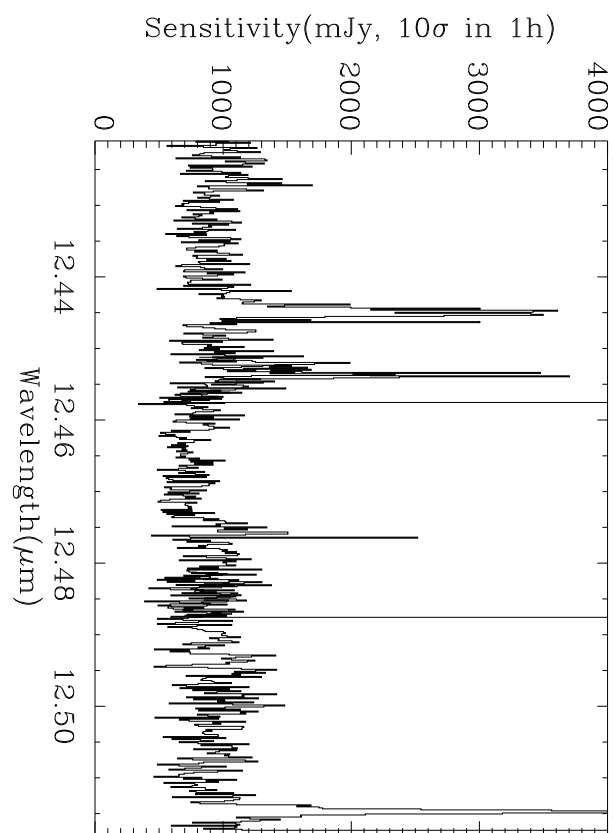

Figure 29: **Measured on the old DRS detector.** Observed sensitivity as a function of wavelength for high resolution mode. Offered sensitivity is typically a factor of 2 larger.

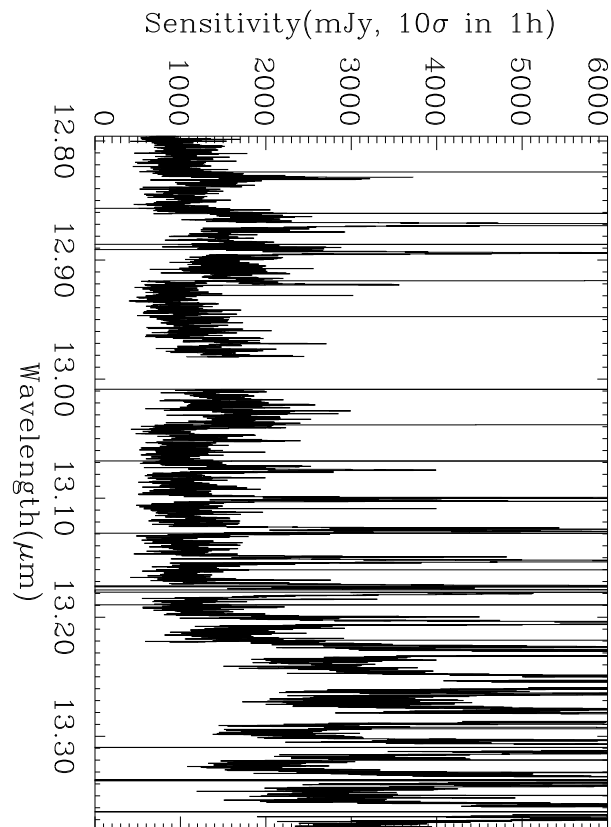
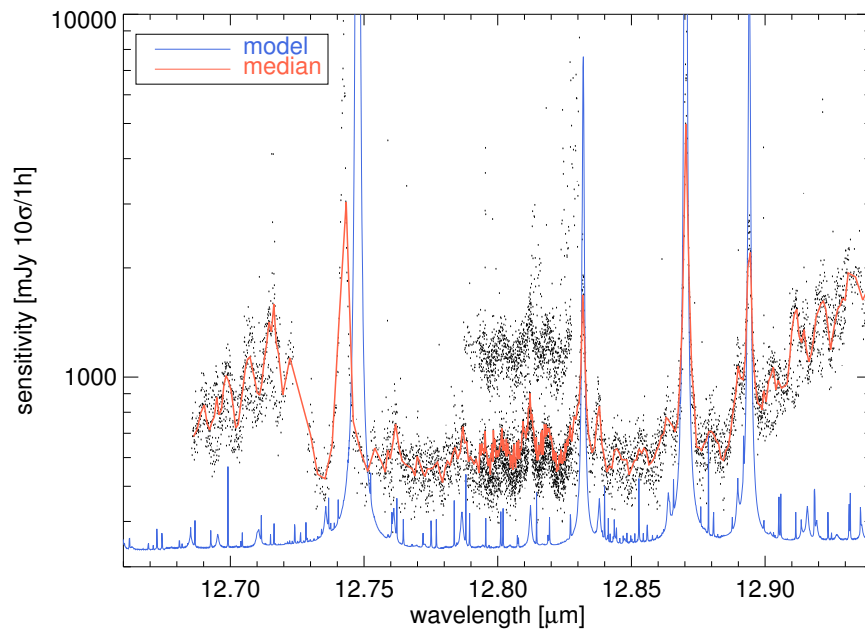

Figure 30: **Measured on the old DRS detector.** Observed sensitivity as a function of wavelength for high resolution mode. *Top:* Observed sensitivities obtained on various nights, compared with the theoretical model curves, corresponding to BLIP. *Bottom:* Sensitivities over an extended region encompassing the observed wavelength of [NeII] up to $z \approx 0.038$.

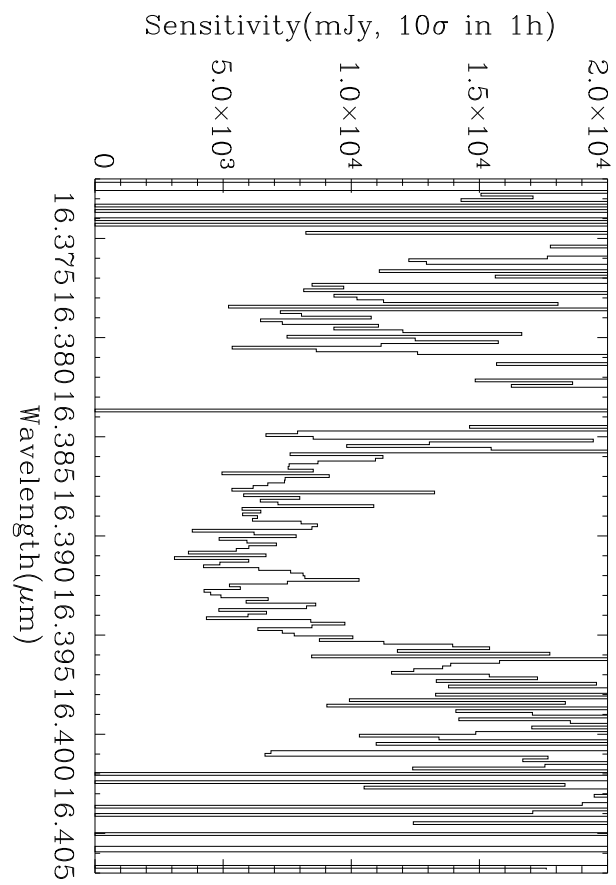

Figure 31: **Measured on the old DRS detector.** Observed sensitivity as a function of wavelength for high resolution mode. Offered sensitivity is typically a factor of 2 larger.

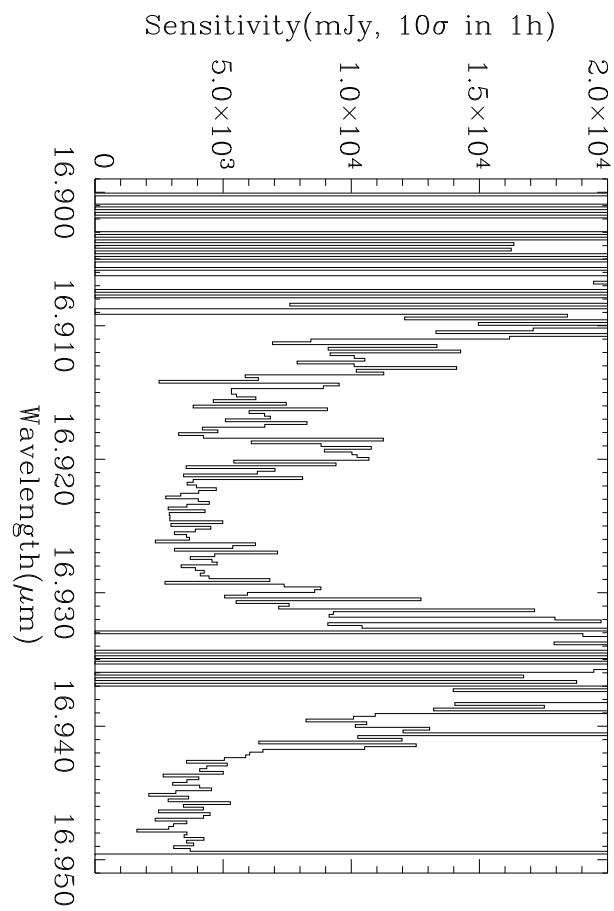

Figure 32: **Measured on the old DRS detector.** Observed sensitivity as a function of wavelength for high resolution mode. Offered sensitivity is typically a factor of 2 larger.

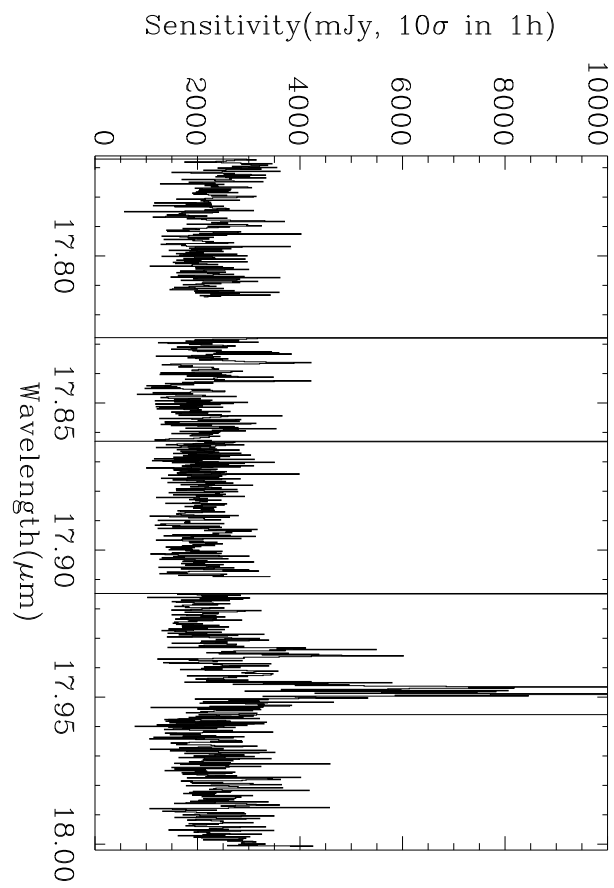

Figure 33: **Measured on the old DRS detector.** Observed sensitivity as a function of wavelength for high resolution mode. Offered sensitivity is typically a factor of 2 larger.

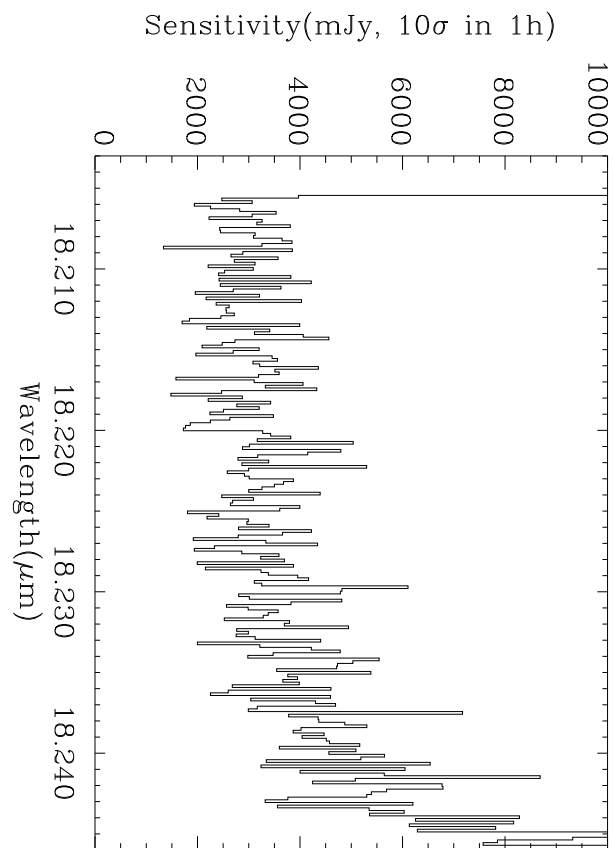

Figure 34: **Measured on the old DRS detector.** Observed sensitivity as a function of wavelength for high resolution mode. Offered sensitivity is typically a factor of 2 larger.

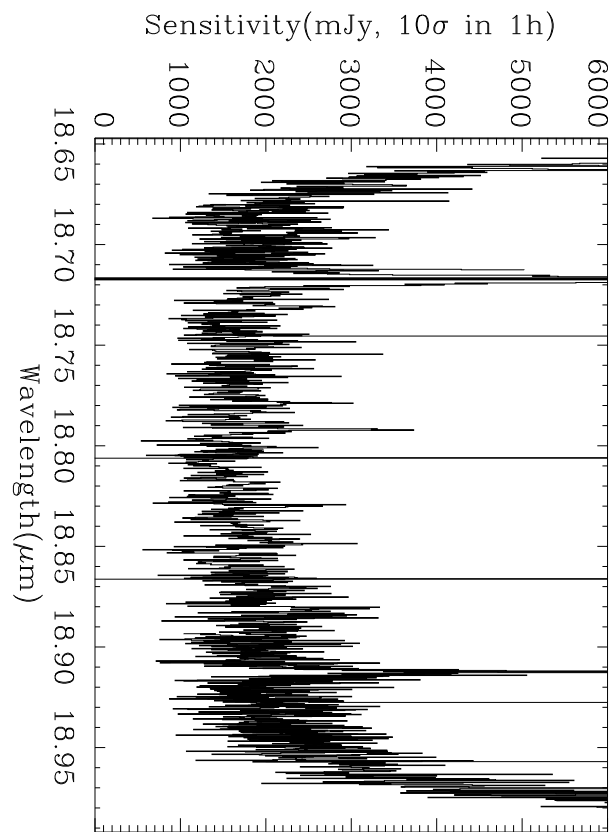

Figure 35: **Measured on the old DRS detector.** Observed sensitivity as a function of wavelength for high resolution mode. Offered sensitivity is typically a factor of 2 larger.

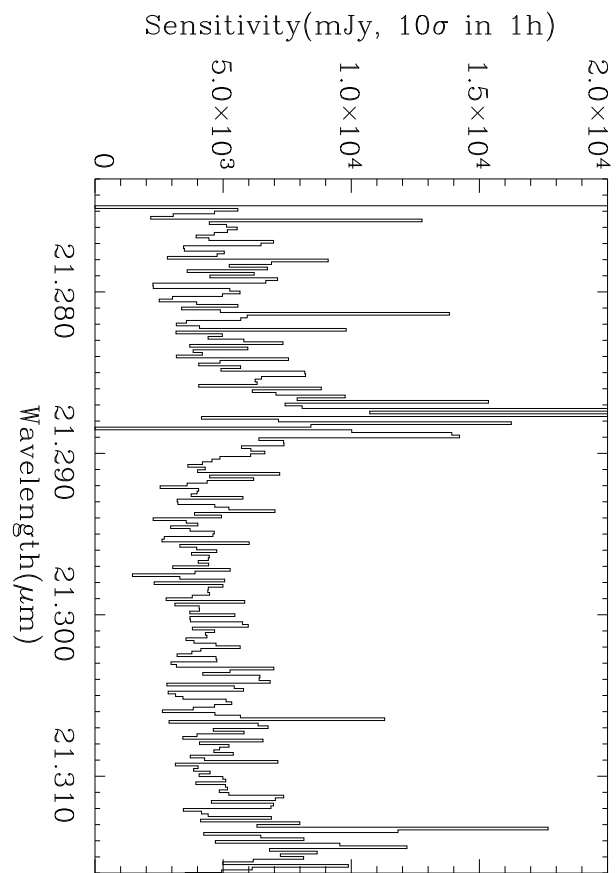

Figure 36: **Measured on the old DRS detector.** Observed sensitivity as a function of wavelength for high resolution mode. Offered sensitivity is typically a factor of 2 larger.