

The Messenger



No. 184 | 2021

Impact of Satellite Constellations and ESO's Role in Supporting the Community
2020 Scientific Prioritisation Community Poll
The Investigate Stellar Population In RElics (INSPIRE) Project
ESO's First e-Conference #H02020



ESO, the European Southern Observatory, is the foremost intergovernmental astronomy organisation in Europe. It is supported by 16 Member States: Austria, Belgium, the Czech Republic, Denmark, France, Finland, Germany, Ireland, Italy, the Netherlands, Poland, Portugal, Spain, Sweden, Switzerland and the United Kingdom, along with the host country of Chile and with Australia as a Strategic Partner. ESO's programme is focussed on the design, construction and operation of powerful ground-based observing facilities. ESO operates three observatories in Chile: at La Silla, at Paranal, site of the Very Large Telescope, and at Llano de Chajnantor. ESO is the European partner in the Atacama Large Millimeter/submillimeter Array (ALMA). Currently ESO is engaged in the construction of the Extremely Large Telescope.

The Messenger is published, in hardcopy and electronic form, four times a year. ESO produces and distributes a wide variety of media connected to its activities. For further information, including postal subscription to The Messenger, contact the ESO Department of Communication at:

ESO Headquarters
Karl-Schwarzschild-Straße 2
85748 Garching bei München, Germany
Phone +498932006-0
information@eso.org

The Messenger
Editor: Mariya Lyubenova
Editorial assistant: Isolde Kreutle
Copy-editing, Proofreading:
Peter Grimley
Layout, Typesetting, Graphics:
Mafalda Martins
Design, Production: Jutta Boxheimer
www.eso.org/messenger/

Printed by omb2 Print GmbH,
Lindberghstraße 17, 80939 Munich,
Germany

Unless otherwise indicated, all images in The Messenger are courtesy of ESO, except authored contributions which are courtesy of the respective authors.

© ESO 2021
ISSN 0722-6691

Contents

The Organisation

Williams, A. et al. – Analysing the Impact of Satellite Constellations and ESO's Role in Supporting the Astronomy Community	3
Mérand, A. et al. – Report on the Scientific Prioritisation Community Poll (2020)	8

Instrumentation

Zwaan, M. et al. – A Guide to ALMA Operations and Interactions with the Community	16
Quertier, B. et al. – Upgrade Strategies for the ALMA Digital System	20

Astronomical Science

Spiniello, C. et al. – The INvestigate Stellar Population In RELics (INSPIRE) Project – Scientific Goals and Survey Design	26
---	----

Astronomical News

Anderson, R. I. et al. – Maintaining Scientific Discourse During a Global Pandemic: ESO's First e-Conference #H02020	31
Miles-Páez, P. A. & Gentile Fusillo, N. P. – Fellows at ESO Personnel Movements	37
	39

Front cover: This photo, taken at ESO's Paranal Observatory, shows the four Unit Telescopes and one of the Auxiliary Telescopes of the Very Large Telescope (VLT) and the VLT Survey Telescope (VST), captured from an unusual perspective. Taken using a fish-eye lens, this photography technique produces a 360 degree view of the location — creating an immersive Paranal world with the swirling Milky Way at the centre of it. Credit: ESO/B.Tafreshi (twanight.org)



Analysing the Impact of Satellite Constellations and ESO's Role in Supporting the Astronomy Community

Andrew Williams¹
Olivier Hainaut¹
Angel Otarola¹
Gie Han Tan¹
Giuliana Rotola¹

¹ ESO

In the coming decade, up to 100 000 satellites in large constellations could be launched into low Earth orbit. The satellites will introduce a variety of negative impacts on astronomy observatories and science, which vary from negligible to very disruptive depending on the type of instrument, the position of the science target, and the nature of the constellation. Since the launch of the first batch of SpaceX's Starlink constellation in 2019, the astronomy community has made substantial efforts to analyse the problem and to engage with satellite operators and government agencies. This article presents a short summary of the simulations of impacts on ESO's optical and infrared facilities and ALMA, as well as the conducted observational campaigns to assess the brightness of satellites. It also discusses several activities to identify policy solutions at the international and national level.

Introduction

The optical astronomy community was taken largely by surprise upon the launch of the first batch of SpaceX's Starlink satellite constellation on 23 May 2019. In their immediate post-launch configuration the 60 satellite units were visible as a very bright "string of pearls" travelling at high velocity across the night sky, and generated substantial public, media and astronomy community interest. ESO, along with many other observatories, national agencies, societies and the International Astronomical Union (IAU) issued public statements¹. The community quickly became aware of the plans of many other companies and nations to develop similar constellations.

A satellite constellation is defined as "a number of similar satellites, of a similar type and function, designed to be in similar, complementary, orbits for a shared

purpose, under shared control" (Wood, 2003). Currently operating constellations serve a variety of important and crucial functions for society, including: navigation and geodesy (for example, GPS, Galileo and GLONASS), satellite telephony (for example, Iridium), internet and TV (for example, ViaSat, Orbcom, GlobalStar) and Earth observation (for example, Copernicus and Planet). In the future, companies such as SpaceX, Amazon, Samsung, Telesat and OneWeb, and several national entities (for example, the Chinese and Indian Space Agencies) are planning very large constellations in low Earth orbit (LEO). These systems aim to provide low-latency broadband internet around the world to support the "Internet of Things" to connect directly machines and systems, financial and gaming transactions, and military applications. Their ultimate goal is to provide global high-bandwidth connectivity, including to remote places such as the middle of an ocean or a remote village (Curzi, Modenini & Tortora, 2020).

We were asked by the ESO Director General to analyse the impacts on ESO's facilities and to support the emergent community efforts with national societies and the IAU to study the issue and identify mitigations. In this article, we present a short summary of the outcome of the simulations of the impact on ESO's optical and infrared facilities and the observational campaigns conducted, and discuss several activities to develop policy solutions at the international and national level.

Impacts on ESO facilities and astronomical science

Visible and infrared spectral range

Drawing on public filings to the International Telecommunications Union (ITU) and also national regulatory agencies, we estimated the number of planned satellite constellations and the numbers of their individual units, as shown in Table 1. The following work uses the Starlink 1st and 2nd generations, OneWeb and GuoWang as a representative worst case scenario, totalling over 60 000 satellites between altitudes of 300 and 1200 kilometres. We used three independent methods to evaluate the number of satellite trails that will cross a field of view, as a function of the

Constellation (Registering nation)	Altitude (km)	Number of satellites	
Starlink Generation 1 updated (US)	550	1584	
	540	1584	
	570	720	
	560	348	
	560	172	
Starlink Generation 1 Phase 2 (US)	335	2493	
	341	2478	
	346	2547	
Starlink Generation 2 (US)	328	7178	
	334	7178	
	345	7178	
	360	2000	
	373	1998	
	499	4000	
	604	144	
614	324		
OneWeb Phase 2 reduced (US, UK)	1200	1764	
	1200	2304	
	1200	2304	
Amazon Kuiper (US)	590	784	
	610	1296	
	630	1156	
Guo Wang GW-A49 (China)	590	480	
	600	2000	
	508	3600	
	1145	1728	
	1145	1728	
Sat Revolution (Poland)	1145	1728	
	350	1024	
	1100	320	
	CASC Hongyan (China)	1100	320
	CASIC Xingyun Lucky Star (China)	1000	156
CommSat (China)	600	800	
Xinwei (China)	600	32	
AstromeTech (India)	1400	600	
Boeing (US)	1030	2956	
LeoSat (Luxembourg)	1423	108	
Samsung (Korea)	2000	4700	
Yaliny (Russia)	600	135	
Telesat LEO (Canada)	1000	117	
Total		78 265	

Table 1. Planned satellite constellations. This table reflects publicly available filings for spectrum from the International Telecommunication Union (ITU) and national communications regulators. Projects are at varying stages of approval. The data for Starlink and OneWeb include recent changes filed at the US Federal Communication Commission (FCC). Some of the operators have withdrawn their applications (for example, Boeing, LeoSat). Only Starlink and OneWeb have launched operational satellites (over 1737 and 218, respectively, as of June 2021). Many more companies have filed applications for other purposes such as remote sensing. As these are typically much smaller — and hence fainter — than telecommunication satellites, they are not considered in the analysis.

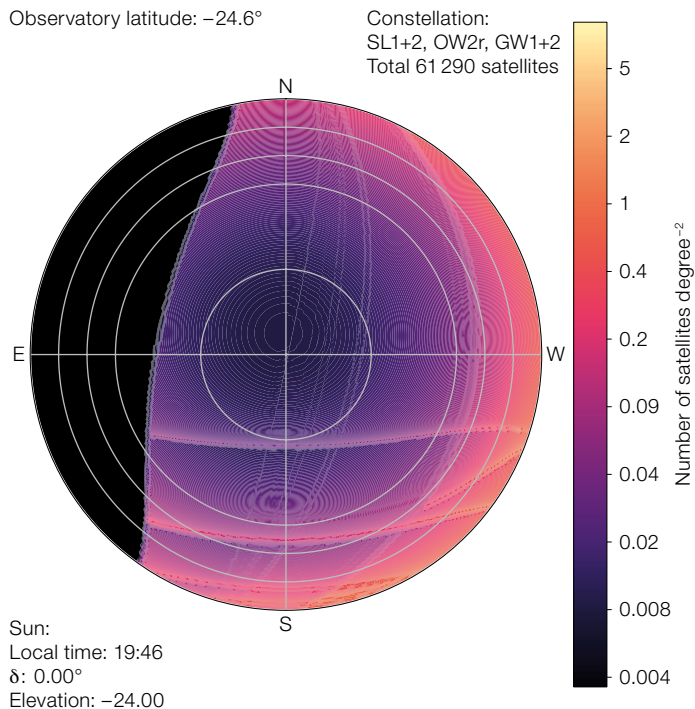

Figure 1. (Upper left) An example distribution of satellites over Paranal observatory. This figure shows a map of the sky above Paranal at the beginning of an equinox night, showing a representative distribution of Starlink, OneWeb, and GuoWang satellites. Of the total of 61 290 satellites, 2562 are above the horizon, including 1373 illuminated ones. The colour indicates

the density of illuminated satellites (in objects degree⁻²). The east-west features correspond to the edges of constellations whose inclinations are close to the latitude of the site. The dark crescent to the east marks the area where all satellites are already in the Earth's shadow.

instrument characteristics, the pointing azimuth and altitude, the local time of night, and the time of year. The methods can either produce statistics for the whole or numerical values for specific directions of observation, fields of view and integration times. The three methods give good agreement; further technical details are available in Walker et al. (2020). Figure 1 displays the result of one of these simulations. The effect on observations scales with the number of satellites, so the effect of the current ~ 2000 constellation satellites is about 3.5% of what is discussed below.

To evaluate the losses to an observation, we counted the number of satellite trails crossing the field of view during the exposure, considering the brightness and apparent angular velocity of each satellite. We excluded those that are too faint to be detected. Those that are detected destroy a 5-arcsecond-wide trail across the observation, and those saturating

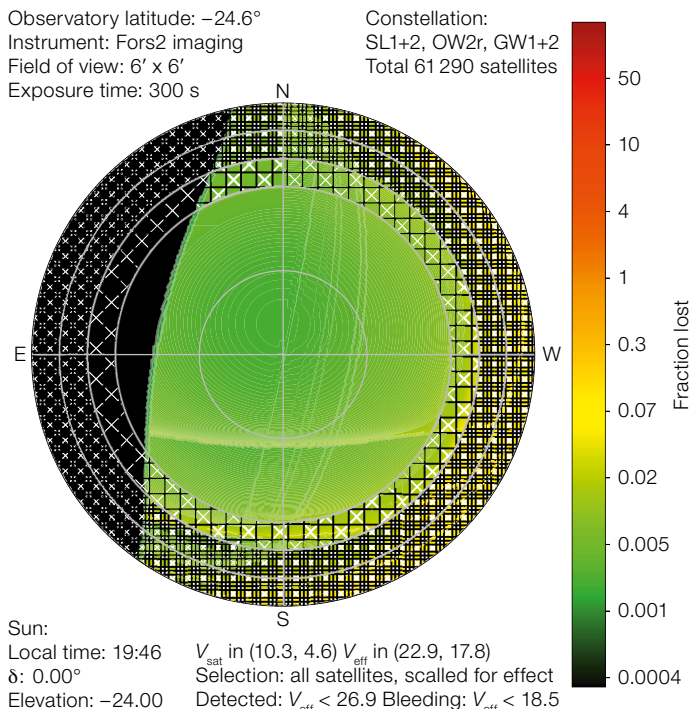

Figure 2. (Upper right) The effect of the satellites on an exposure. As in Figure1, this map of the sky above Paranal observatory shows the effect of the satellites on a 300-second image obtained with the Focal Reducer and low dispersion Spectrograph (FORS), as a function of the direction of pointing. The high airmass regions are hatched. The colour indicates the fraction of exposures lost.

the detector destroy the whole observation. Figure 2 shows an example for a 300-second image with FORS. The losses, averaged over zenithal distances below 60 degrees (airmass 2 and better, representing 95% of observations with the Very Large Telescope), are presented in Figure 3 for a series of representative instruments. Because of the apparent concentration of satellites towards the horizon, the values in the figure should be about doubled when setting the limit at a zenithal distance of 70 degrees, and halved when considering only 30 degrees around the zenith. The figure shows that most instruments will suffer losses at the $\leq 1\%$ level at twilight, that figure dropping by 1–2 orders of magnitude when the sun reaches an elevation of -40 degrees. Because of their brighter limiting magnitudes, the high-resolution spectrographs are essentially immune to the satellites considered. The low-resolution spectrograph will be able to register some of the satellites as low-signal-to-noise contami-

nation, which could be difficult to disentangle from the science signal. Vera C. Rubin Observatory, with its 3 degree imager behind an 8-metre telescope, is particularly affected. Its situation is made worse by the effect of saturated trails on the camera, resulting in losses of up to about 30% for observations at twilight.

The situation in the thermal infrared is completely different: the satellites are emitters, so they remain a source of contamination even when in Earth's shadow, and they are well above the detection threshold of instruments like the VLT Imager and Spectrometer for mid-InfraRed (VISIR) (Hainaut & Williams, 2020). However, the field of view of a thermal IR instrument is small, and the individual exposure time is very short, so only a negligible fraction of the exposures will be affected. A satellite passing in front of a star will cause a short eclipse. However, because of their high apparent angular velocity, it lasts of the order of 1 millisecond, and will cause

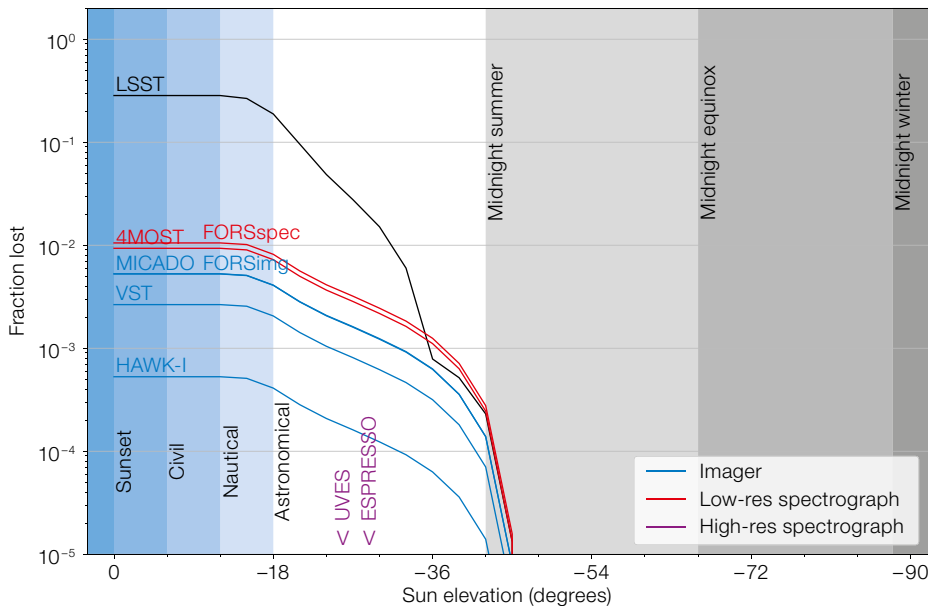

Figure 3. The mean fraction of exposure lost due to satellite trails as a function of the solar elevation, for representative exposures obtained at zenithal distances smaller than 60 degrees. The twilights and the solar elevation at midnight are indicated with shading. The exposures are as follows: the Vera C. Rubin Observatory LSST Camera — 15 seconds; the 4-metre Multi-Object Spectrograph Telescope (4MOST) on the Visible and Infrared Survey Telescope for Astronomy (VISTA) — fraction of contaminated fibres for 1200 seconds; the VLT Survey Telescope (VST) — 300 seconds; FORS — 1200 seconds for spectroscopy, 300 seconds for imaging; the High Acuity Wide-field K-band Imager (HAWK-I) — 60 seconds; the Multi-AO Imaging Camera for Deep Observations (MICADO) — 60 seconds; the Ultraviolet and Visual Echelle Spectrograph (UVES) — 1 hour, the Echelle SPectrograph for Rocky Exoplanet and

Stable Spectroscopic Observations (ESPRESSO) — 1 hour. The simulations account for the limiting magnitude and saturation magnitude of the systems; they assume that a detected satellite ruins a 5-arcsecond-wide trail across the detector, and that a saturated satellite ruins the whole exposure. In the case of fibre-fed spectrographs (ESPRESSO, 4MOST), a detected satellite ruins the exposure. For 4MOST, a multi-fibre spectrograph, the number of trails in the field is converted into the number of affected fibres using a Monte-Carlo simulation which indicates that on average a satellite will affect 1.254 fibres. FORS images are affected at a level comparable to that of the much wider field VST because it is sensitive to much fainter satellites. In the cases of ESPRESSO and UVES, the spectrographs are not sensitive to the fast-moving satellites.

a detectable dip in the signal of the star only for very fast photometry (< 1 second).

Several mitigations have been identified that can reduce the impacts on astronomical facilities. The first option would be to reduce the number of satellites, lower their orbital altitude and minimise their size. Existing constellation designs, however, are already highly optimised and linked to the spectrum assigned by regulatory authorities. Post-hoc changes are likely to be challenging, and therefore the community should focus on influencing operators in the early design stages. Other operator mitigations focus on design measures to darken satellites and avoid reflected sunlight. Observatories can introduce scheduling based on the simulation results (for example, pointing to the darkest areas in maps like that of Fig-

ure 2), or consider shutter-control measures and additional small telescopes, or suitable wide-field cameras, to detect satellites during or just before observations so as to either avoid them or identify contaminated data. The level and complexity of the telescope or operations mitigations put in place must be commensurate to the effect they correct. For many types of observations, it might be cheaper and more efficient just to repeat a failed observation. Currently, the impact on ESO visible and infrared facilities will remain low enough that no telescope/instrument or scheduling mitigations are foreseen, but we are closely monitoring developments.

The astronomy community, particularly in the US, has had a very productive collaboration with SpaceX aimed at reducing

the brightness of satellites. SpaceX trialed a dark coating on “DarkSat” Starlink, which achieved some brightness reduction, but had implications for the thermal control and was subsequently abandoned in favour of attitude adjustments and a new “VisorSat²”. This features the addition of a sunshade which protects the body of the satellite from direct illumination, and which is mounted so that the illuminated side of the shade is not visible from Earth. Preliminary measurements suggest darkening by a factor of about 3 compared to first-generation satellites. VisorSats have been launched since mid-2020. Adjustments of the attitude of the satellites have also reduced their brightness: the orientation of the solar panel has been adjusted to keep it invisible from the ground, hidden behind the bus of the satellite.

Millimetre and submillimetre spectral range

Of the satellite constellations listed in Table 1 the Starlink Generation 1 may impact ALMA as downlink transmitters since the end-user terminals are planned to operate at frequencies between 37.5 and 42.5 GHz, which is within the ALMA Band 1 observing range. Whilst operator agreements and observation scheduling could avoid the unlikely case of direct illumination of the ALMA antennas, the cumulative background noise will be a more persistent problem. We assume that the interference from each satellite adds in an uncorrelated way in an ALMA receiver, meaning that the signal power of each satellite can just be added to obtain the total power received from all satellites. Under these assumptions a total noise increase due to the Starlink Generation 1 satellites of about 50 millikelvins at the input of an ALMA Band 1 receiver is expected. Longer integration times should compensate for this noise. Where this cannot be done, reductions in sensitivity will have to be accepted, although this requires more detailed study. If a significant noise increase is expected, this should be included in the ALMA Sensitivity Calculator so that the correct integration times can be derived. Further details are available in a report made for ESO’s 155th Council Meeting³.

The Starlink Generation 2 constellation does not mention the use of a downlink to user terminals in ALMA Band 1; this function is foreseen at lower frequencies where ALMA does not observe. However, a request has been made as part of the US Federal Communication Commission (FCC) licence application to operate a gateway downlink in the frequency range 71–76 GHz which falls in ALMA Band 2. Since the number of gateways will be much less than the number of end-user terminals, interference to ALMA is expected to be a lesser concern. This assumes that these gateway terminals are not located close to the ALMA observatory. Planning the location of the gateway terminals needs licensing from the Chilean national authorities and it is recommended that the Joint ALMA Observatory be actively involved in this process. At the time of writing, SpaceX has submitted a request to the Chilean regulatory body, SubTel, to operate four gateways on Chilean territory.

Satellite observations

Satellite observations have provided an important complement to simulations to calibrate assumptions and to characterise brightness over a range of wavelengths and from different locations and orbital geometries. Satellites exhibit highly dynamic changes in apparent brightness that are due to geometrical and operational factors, requiring many observations to capture the changes in brightness over the full range of parameters. Assessing impacts on astronomy also requires knowledge of satellites' apparent velocity, position in the sky, and frequency of sightings.

Observations of the brightness magnitude of the Starlink and OneWeb satellites have been made for the purposes of a) determining how bright they are in various astronomical spectral bands of interest, and b) in the case of the Starlink satellites, determining how effective are the engineering design changes implemented to decrease their brightness and meet the recommendations of the SATCON1 (Walker et al., 2020) and the Dark and Quiet Skies for Science and Society (IAU 2020) workshops. SpaceX launched a mitigation satellite, Starlink-1130^a (dubbed DarkSat), that included a special darkening treatment of the Earth-facing sides of the satellite structure. This was intended to

make it less reflective of sunlight and effectively dimmer.

The satellites Starlink 1130 (DarkSat) and Starlink 1113^b, launched on 7 January 2020, were observed on 3 March 2020 immediately after arriving at their nominal operational orbital height of 550 kilometres. The analysis of the observations produced a brightness magnitude (in Sloan Digital Sky Survey *g'* filter, scaled to zenith and range 550 kilometres) of 5.33 ± 0.05 and 6.10 ± 0.04 magnitudes for Starlink 1113 and 1130 (DarkSat), respectively (Tregloan-Reed et al., 2020). These results showed that a) the reduction in brightness for DarkSat was $50.8\% \pm 3.5\%$, b) the brightness magnitude of DarkSat (6.10 magnitudes) was still within the range of the naked-eye limiting magnitude of an experienced observer (Bortle, 2001) and c) DarkSat was still brighter than the limiting magnitude of 7 that has been recommended to minimise unwanted effects in sensitive astronomical cameras (Walker et al., 2020; IAU 2020). Subsequent observations of these satellites were conducted in various spectral bands to assess their brightness and the effectiveness of the darkening treatment used in DarkSat, in various astronomical spectral bands from visible to near-infrared (Tregloan-Reed et al., 2021). The results of these observations, conducted using the Chakana telescope (Char et al., 2016) and VIRCAM (Emerson, McPherson & Sutherland, 2006; Dalton et al., 2006) on the VISTA telescope, are summarised in Figure 4. The results shown in Figure 4 illustrate that the non-darkened Starlink satellites are brighter, and that the effectiveness of the darkening treatment decreases with increasing wavelength.

For completeness, observations of the Starlink VisorSat (IAU 2020) measure a magnitude in the visible similar to that reported here for DarkSat. Observations of OneWeb satellites (Tregloan-Reed et al., in preparation), operating at an orbital height of 1200 kilometres, show that their brightness in the visible is about 8 magnitude. However, in 46% of these observations the satellites are brighter than the SATCON1 recommendation of 7.85 magnitude for a satellite at this altitude.

Policy activities and the way forward

The simulations and observations outlined here have been facilitated by the coordinated efforts of several national societies, such as the American Astronomical Society, the Royal Astronomical Society and the European Astronomical Society, amongst others, along with input from observatories such as ESO, Vera C. Rubin Observatory, NSF's NOIRLab and the Square Kilometre Array Observatory. This body of work has established a basis for understanding the problem space and yielded promising early results on operator mitigations. The bilateral work with companies is welcome but is not a sustainable solution as the number of private and public constellation projects around the world grows. Astronomers are now beginning to look for regulatory solutions at both international and national levels.

At the international level, ESO supported the IAU in submitting a set of policy recommendations⁴, developed in the Dark and Quiet Skies project (IAU 2020), to the United Nations Committee on the Peaceful Uses of Outer Space (COPUOS), which addresses international dialogue on governance of the use and exploration of outer space. The recommendations call for, *inter alia*, international agreement to address impacts on astronomy by minimising the orbital altitude, the brightness of space objects to less than unaided-eye levels (7 magnitude), and antenna sidelobe emissions such that their indirect illumination of radio observatories and radio-quiet zones does not interfere, individually or in aggregate. Most importantly, the work aimed to create a norm of cooperation within the astronomy community and consideration of impacts on science and on the dark sky at the design and early regulatory approval of projects. The paper, which was co-signed by the IAU and five countries (Chile, Ethiopia, Jordan, Slovakia and Spain), was submitted to the 58th session of the Science and Technical Sub-Committee of COPUOS held on 19–30 April 2021. Many COPUOS members voiced support for the astronomy community's concern and the need to find solutions, and the Committee agreed that the IAU should continue to study the matter further and report back to the 2022 session.

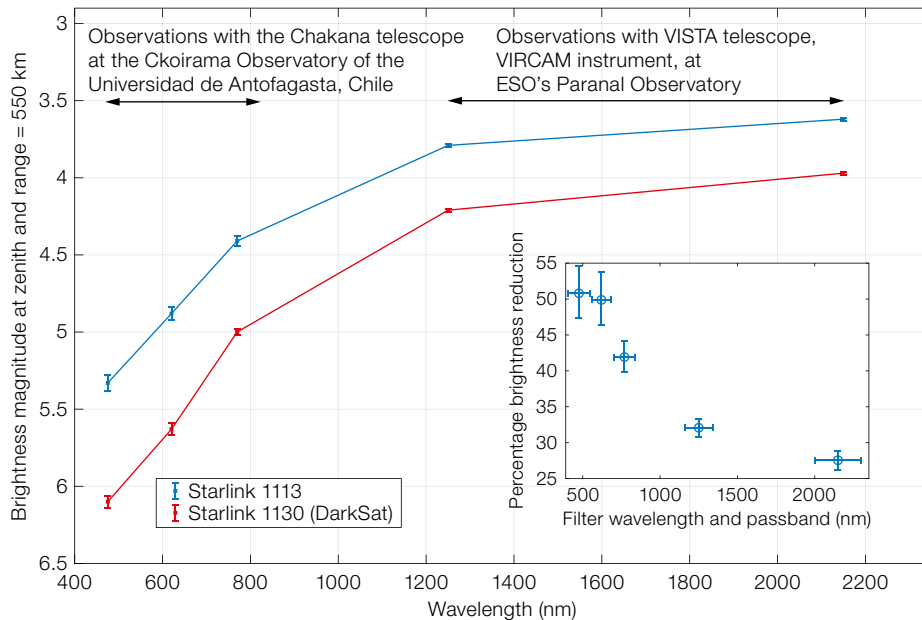

Figure 4. Brightness magnitude of Starlink satellites 1130 (DarkSat) and 1113. Data extracted from Tregloan-Reed et al., (2020, 2021). The insert shows the computed reduction in brightness for Starlink-1130 (DarkSat), similarly to Figure 6 in Tregloan-Reed et al. (2021).

Whilst COPUOS is an important forum in which to raise awareness and possibly agree non-binding guidelines, a binding international treaty to implement the IAU policy guidelines is highly unlikely. Instead, the astronomy community must look to national regulatory authorities. In this regard, the primary issue is that, apart from a narrowly-focused law in the US preventing “space billboards”⁵ no states have yet regulated optical pollution from space, and the ITU does not include optical frequencies in its Radio Regulations. A concern for radio astronomers is that so-called Radio-Quiet Zones, while offering protection from ground-based radio emitters, do not cover space-based radiation sources. Several activities to look for regulatory solutions are proceeding, starting with the US-led SATCON2 project⁶ to explore the possibilities for legal protection under environmental law, in addition to addressing national launch and communications regulators and standards bodies.

Despite the partial success of recent operator mitigations and some possibilities for introducing regulations to compel operators to coordinate with astronomers and make design changes to satellites, no combination of mitigations can fully avoid impacts on astronomy. With the possibility of 100 000 satellites launching in the coming decades, the impacts on

astronomy are one concern amongst many in this new megaconstellation era (Boley & Byers, 2021). This large number of satellites in LEO creates a major concern in terms of orbital crowding, collision avoidance and control of debris. Whilst various space agencies are considering the problem, the existing space governance system is being stretched to its limits. We hope the astronomy community, along with all space actors and beneficiaries of pristine dark and quiet skies, will work towards a shared stewardship of the night sky in a way that supports conservation, economic development, science and exploration and sustainability of the environment.

References

- Bortle, J. E. 2001, *Sky & Telescope*, February 2001
- Boley, A. C. & Byers, M. 2021, *Sci Rep*, 11, 10642
- Char, F. et al. 2016, *BAAA*, 58, 200
- Curzi, G., Modenini, D. & Tortora, P. 2020, *Aerospace*, 7(9), 133
- Dalton, G. B. et al. 2006, *Proc. SPIE*, 6269, 62690X
- Emerson, J., McPherson, A. & Sutherland, W. 2006, *The Messenger*, 126, 41
- Hainaut, O. R. & Williams, A. P. 2020, *A&A*, 636, A121
- IAU 2020, *Dark and Quiet Skies for Science and Society — Report and Recommendations*
- Tregloan-Reed, J. et al. 2020, *A&A*, 637, L1
- Tregloan-Reed, J. et al. 2021, *A&A*, 647, A54
- Walker, C. et al. 2020, *Bull. AAS*, 52(2)
- Wood, L. 2003, *Satellite constellation networks, Internetworking and Computing over Satellite Networks*, (Boston: Springer), 13

Links

- ¹ ESO public statement: <https://www.eso.org/public/announcements/ann19029/>
- ² SpaceX’s VisorSat: <https://spacex.com/spacex-to-test-starlink-sun-visor-to-reduce-brightness/>
- ³ Report presented to the ESO Council: http://www.eso.org/public/about-eso/committees/cou/cou-155th/external/Cou_1928_Satellite_Constellations_161120.pdf
- ⁴ Policy recommendations submitted to COPUOS: <https://www.iau.org/static/publications/uncopuos-stsc-crp-8jan2021.pdf>
- ⁵ US law on space advertising: <https://www.law.cornell.edu/uscode/text/51/50911>
- ⁶ Announcement of SATCON2 workshop: <https://aas.org/posts/news/2021/05/satellite-constellations-2-workshop-announced>

Notes

- ^a Starlink 1130 satellite, NORAD ID 44932, COSPAR ID 2020-001U
- ^b Starlink 1113 satellite, NORAD ID 44926, COSPAR ID 2020-001N

Report on the Scientific Prioritisation Community Poll (2020)

Antoine Mérand¹
 Paola Andreani¹
 Michele Cirasuolo¹
 Fernando Comerón¹
 Itziar De Gregorio Monsalvo¹
 Miroslava Dessauges-Zavadsky²
 Éric Emsellem^{1,3}
 Rob Ivison¹
 Francisca Kemper¹
 Franz Kerschbaum⁴
 Bruno Leibundgut¹
 Jochen Liske⁵
 Ross McLure⁶
 Tony Mroczkowski¹
 Livia Origlia⁷
 Neil Philips¹
 Hugues Sana⁸

- ¹ ESO
- ² Department of Astronomy, University of Geneva, Switzerland
- ³ CRAL, University Claude Bernard Lyon 1, ENS of Lyon, France

- ⁴ Department of Astrophysics, University of Vienna, Austria
- ⁵ Hamburg Observatory, Germany
- ⁶ Institute for Astronomy, University of Edinburgh, Royal Observatory Edinburgh, UK
- ⁷ INAF – Astrophysics and Space Science Observatory of Bologna, Italy
- ⁸ Institute of Astrophysics, KU Leuven, Belgium

ESO regularly updates its science-driven perspective in order to provide the best facilities and services for its community. As part of this exercise, ESO polled its users between January and February 2020. Questions were inspired by the previous poll, conducted in 2015, to probe any evolution of community opinions and profile, with an emphasis on the future of the Very Large Telescope (VLT) and the VLT Interferometer (VLTI). Of the approximately 17 700 regis-

tered users targeted, 10% had accounts in both the ESO and European ALMA portals, another 14% were registered in the ALMA portal only, and the remaining 76% were registered in the ESO portal only. Some 3700 email addresses, predominantly associated with the ESO portal, were invalid. From the remaining approximately 14 000 user accounts, 1673 complete responses were received, a response rate comparable to that of the 2015 poll. The present poll was split into three parts: 1) profile of respondent; 2) current and future observing facilities; 3) ESO in the coming decade. Here we summarise the results and provide some highlights from the poll.

Respondents' profiles

The poll started with questions designed to assess the profile of each respondent, including their academic and professional

What best describes your current position?

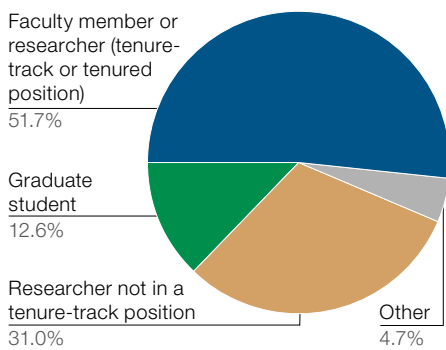

If you have a PhD, for how many years have you had it (choose the closest number of years)?

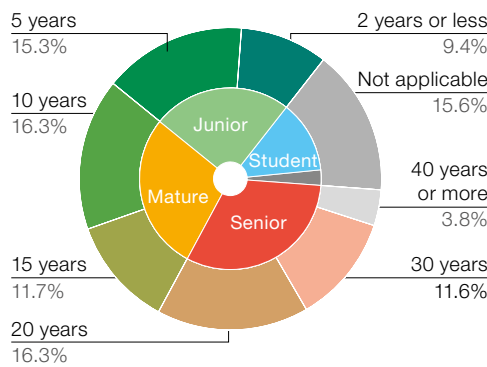

My home institute is best described as:

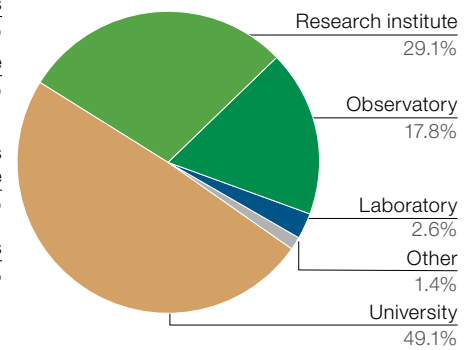

My home institution is located in:

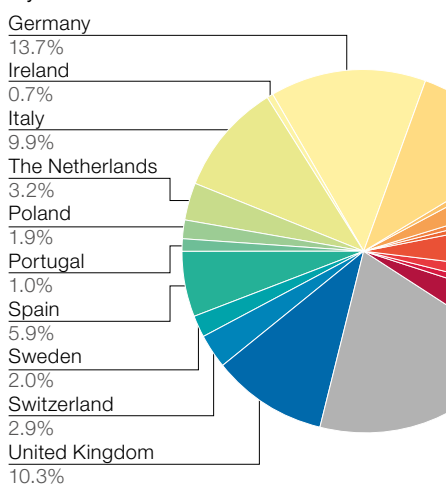

Details for "Other": Countries from which fewer than 10 responses were received

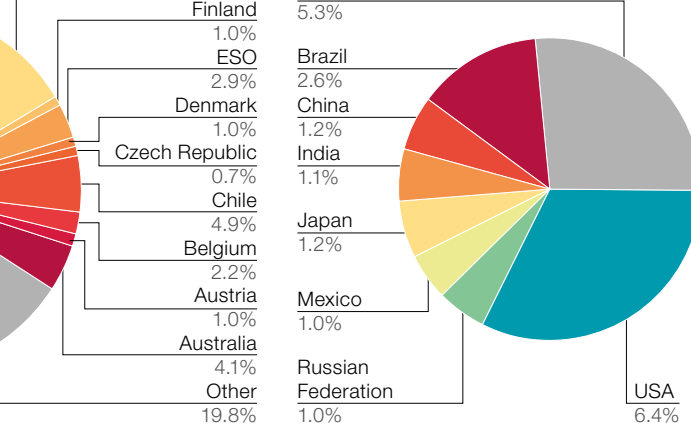

Figure 1. (Above) Respondents' academic profiles. Position (left), years post-PhD (centre) and institution (right).

Figure 2. Respondents' country of home institute.

background. As can be seen in Figure 1, the distribution shows a slight majority of tenured or tenure-track researchers (51.7%), the rest consisting of non-tenured researchers (31.0%) and graduate students (12.6%). Regarding the number of years post-PhD (relevant for 84.4% of respondents), we have a relatively even spread between 2, 5, 10, 15, 20, 30 and 40 years. The respondents are predominantly from universities (49%), with the remainder from research institutes (29%), observatories (18%) and laboratories (3%).

For later analysis, we define career stages (i.e., seniority) as:

- Respondent without PhD degree (15.6%), of which 4/5 were students.
- Junior: up to 5 years post-PhD (24.7%) (an average density of 4.9% per year post-PhD).
- Mature: 5 to 20 years post-PhD (28.0%) (an average density of 1.9% per year post-PhD).
- Senior: more than 20 years post-PhD (31.7%) (an average density of 1.5% per year post-PhD).

Our choices of the ranges of years after a PhD do not have equal spread: if we consider the average density per year post-PhD, we seem to have obtained better response rates from junior people.

The poll collected information about home institutions. Only ESO Member States, Australia as a Strategic Partner, the Host State Chile, and ESO were listed individually. Other countries could be entered manually. Figure 2 shows the relative numbers of answers per country. More than 80% of the respondents are from ESO Member States, associated countries and ESO.

A multiple-choice question probed research categories: Observations; Instrumentation; Theory; Simulations; Other (Figure 3). The vast majority of respondents (90.2%) are involved in observational astronomy, with 10–30% pursuing other types of research. Interestingly, a breakdown by seniority reveals that the Instrumentation category is more strongly represented amongst senior respondents (38%) than amongst students (10.7%): comparatively fewer students participate actively in instrumentation development. Precise comparison with the previous poll (Primas

My research activity focuses on:

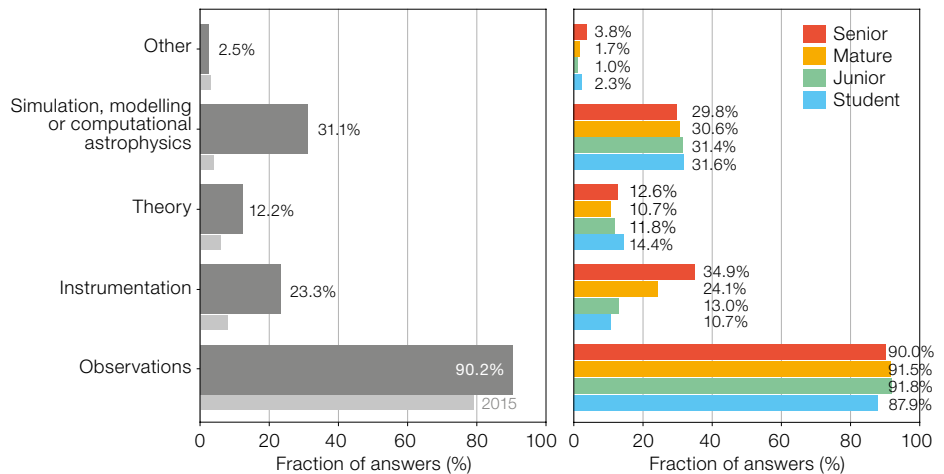

I use data from these wavelength regimes:

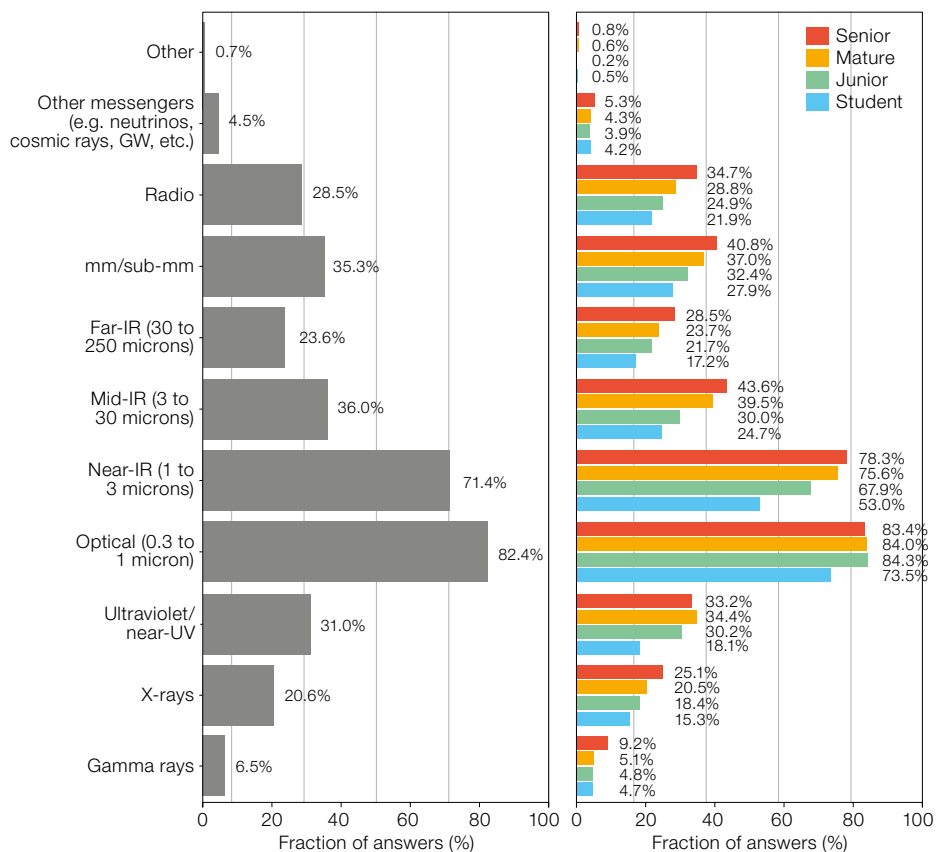

et al., 2015) is difficult, since then only a single answer was allowed to this question. However, the respondents then were also dominated by observational astronomers.

Regarding the part of the electromagnetic spectrum used (Figure 4), the majority of the respondents primarily focus on the

Figure 3. (Upper) Type(s) of research activities (left), with a breakdown by career stage (right). In the left panel, numbers for the 2015 poll are shown as the thinner and lighter grey bar. Note that, in 2015, only one answer was possible.

Figure 4. (Lower) Wavelength domain(s) of research activities (left) and broken down by career stage (right).

optical and near-infrared, with a significant number of respondents working in the submillimetre and radio domains. Only a small fraction of respondents use domains not covered by ESO telescopes (gamma rays, X-rays, far-infrared, radio and other messengers). A breakdown by career stage shows that the more senior researchers tend to use more multi-wavelength/multi-messenger facilities: students, junior, mature and senior scientists use, on average, 2.6, 3.2, 3.5 and 3.8 different spectral ranges and non-electromagnetic messengers, respectively.

Finally, we asked respondents in which domain they currently work, and how important they feel different fields will be in the 2030s (Figure 5). One can compare how popular a field is currently with its perceived importance in the coming decade: the most popular fields, “Structure and evolution of galaxies (including AGNs)” (43.8%) and “Life cycle of stars” (40.6%), are predicted to be very impor-

tant one decade from now by only 24.7% and 16.9% of the respondents, respectively. This difference between current and future importance was also observed five years ago, but only for stellar physics: five years ago the number of people who worked in Galaxy Evolution was equal to the number who thought it would be an important field in the future. The research domains which have the largest difference between the number of respondents engaged in research in that domain and the number who think it will be very important in future are “Search for life outside Earth”, “Planetary system formation and evolution” and “Cosmology and/or fundamental physics”. This is very similar to the 2015 results, again except for “Structure and evolution of galaxies (including AGNs)”.

Present and future facilities

The second part of the poll focused on observing facilities. The first question

aimed at gauging what kind of ground-based capabilities respondents will need in the 2030+ timeframe, with a maximum of three possible choices. The question was split between observing technique, spectral resolution and spectral domain. The results are presented in Figure 6. Polarimetry and high-contrast imaging are the least selected (13% and 16%), whereas integral-field, multi-object and single-object spectroscopy and high-angular-resolution imaging (40%, 39%, 37% and 35%) are the most popular techniques. Interferometry and wide-field and/or low-angular-resolution imaging have intermediate results (26% and 25%).

Comparing with the facilities offered by ESO (present and planned), we can identify the following missing capabilities:

- High-resolution ($R \sim 100\,000$) spectropolarimetry in the visible: this is a capability offered outside of ESO, though not on 8-metre telescopes.
- High-resolution ($R > 10\,000$) interferometry in the visible and near-infrared; high resolution ($R > 10\,000$ k), high-contrast imaging in the near-infrared.

These two capabilities do not yet exist and would offer a unique parameter space.

What are your main areas of astrophysical research?
How important do you think these domains will be in the 2030s?

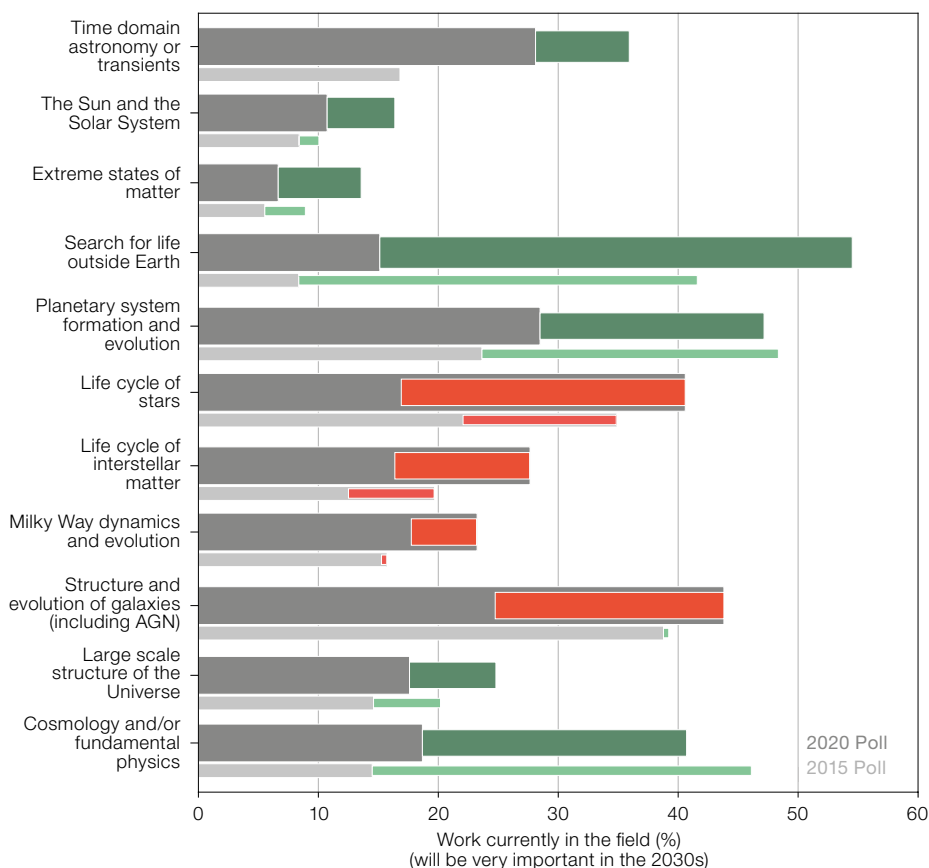

The second question concerned which current ESO facilities are required for future research (Figure 7). The respondents, of which 24% are registered at the ALMA portal, and 86% at the ESO portal, indicated that they would most likely require the VLT and the Extremely Large Telescope for their research (81.4% and 71.9% respectively), followed by the data archive and the Atacama Large Millimeter/submillimeter Array (ALMA) (58.9% and 49.5%, respectively). In 2015, the data archive was not a possible choice. All facilities grew in community interest. Amongst the facilities which grew in perceived importance, the Atacama Pathfinder EXperiment (APEX) jumped by a large factor; ALMA and the VLT roughly doubled in fractional answers. The large fraction of respondents (49.5%) indicating that they intend to use ALMA in

Figure 5. Current field of research (grey bars), and fraction of respondents thinking it will be very important in the future (green bar for increase and red bar for decrease). The thinner and lighter colour bars show the results of the 2015 poll. Note that in 2015, it was not asked whether “Time domain...” will be of importance in the coming decade.

Which of the following ground-based capabilities will be most important for your research in the 2030+ timeframe?

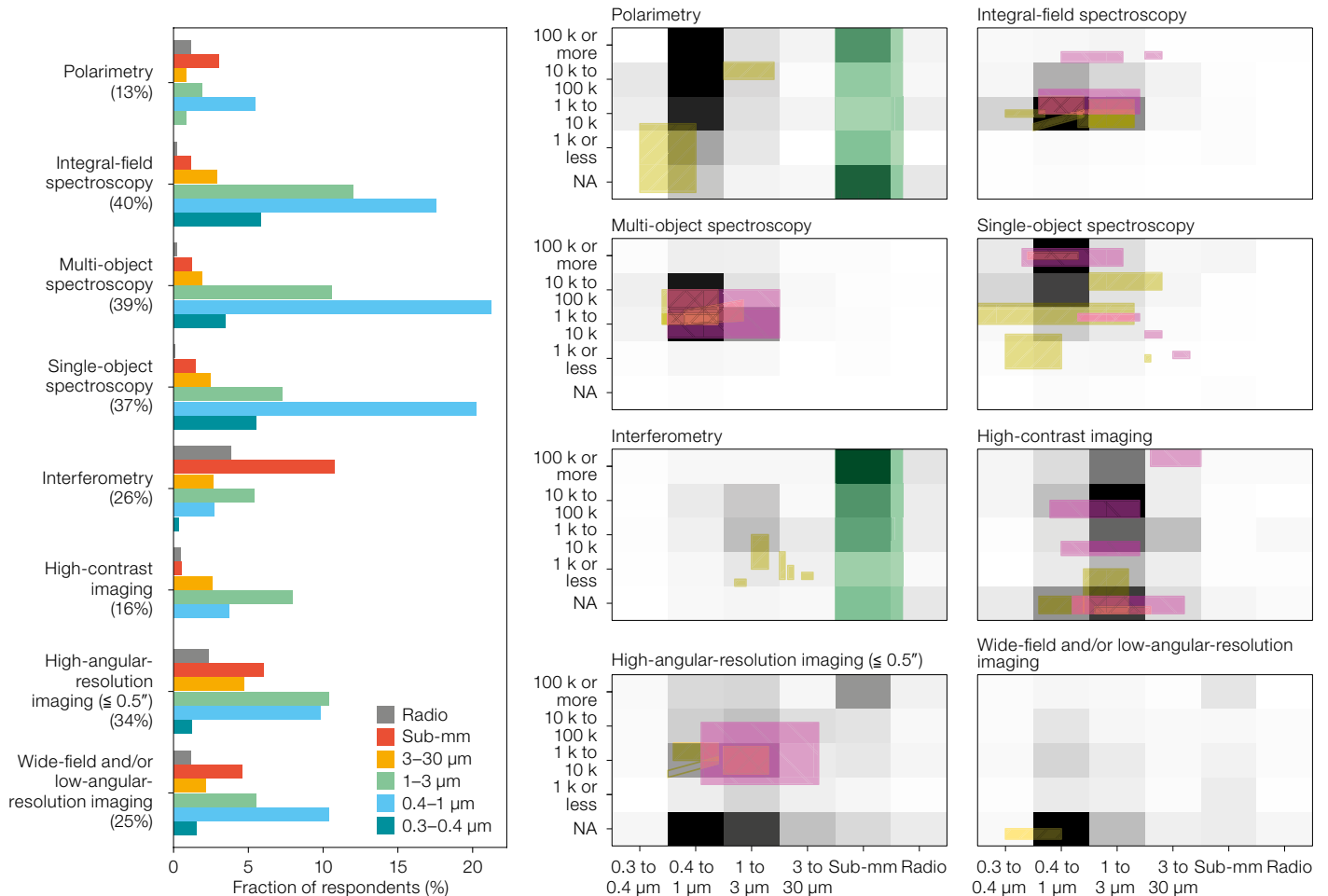

Figure 6. On the left, the fraction of respondents choosing each technique is shown (in percent, broken down into wavelength domains). The right panels show the density maps of the answers, in the “spectral resolution-spectral domain” plane (darker means more answers). Areas covered by VLT and ELT instruments are shown in yellow and purple respectively. Green areas cover ALMA (only for polarimetry and interferometry, even though ALMA covers other aspects).

the future is remarkable, given that only 24% of the users polled are currently registered at the European ALMA portal. Only 4-metre-class telescopes seem to have remained stable since 2015. There do not seem to be any strong generational trends in these answers.

Regarding possible future ground-based facilities (Figure 7, lower left), a large majority (75%) expressed the need for a dedicated spectroscopic telescope. It should be noted that the poll did not define what “dedicated” meant: it could either be a highly multiplexed telescope,

or a telescope dedicated to transient follow up. The other options each attracted about 25% of the respondents. All numbers have at least doubled since 2015, though only a single answer was allowed in the previous poll.

We also polled the community regarding planned facilities, ground- or space-based (Figure 7, right panel). The answers are very similar to those in 2015, with the James Webb Space Telescope (JWST), Vera C. Rubin Observatory (formerly the LSST), Nancy Grace Roman Space Telescope (formerly WFIRST) and the Square Kilometre Array (SKA) (in that order) included as a choice in the 2015 poll.

ESO in the coming decade

We began by asking a question that referred back to the “VLT in 2030” work-

shop held in 2019 (Mérand & Leibundgut, 2019), the purpose of which was to discuss future developments for the VLT and VLTI, in the 2030+ timeframe. Several projects were discussed, and four projects were selected by the Science and Technical Committee (STC) for further review: BlueMUSE, GRAVITY+, HR-MOS, and SPHERE+ (in alphabetical order). Respondents were asked how relevant those projects were for their research. The breakdown of answers by instrument is given in Figure 8.

Something the Figure does not show is that 67% (26%) of the respondents find at least one (two) of the four projects “very relevant”. This percentage climbs to 89% (69%) when “relevant” is also included. This means that at least one VLT2030 instrument captured the interest of the vast majority of respondents. The next question attempted to identify capabilities

Which ESO facilities do your future research objectives require?

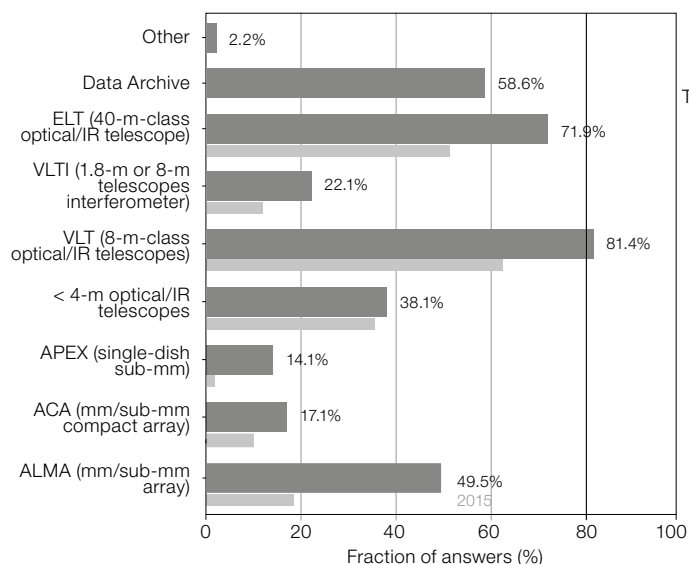

Which other planned facilities are essential for your future research?

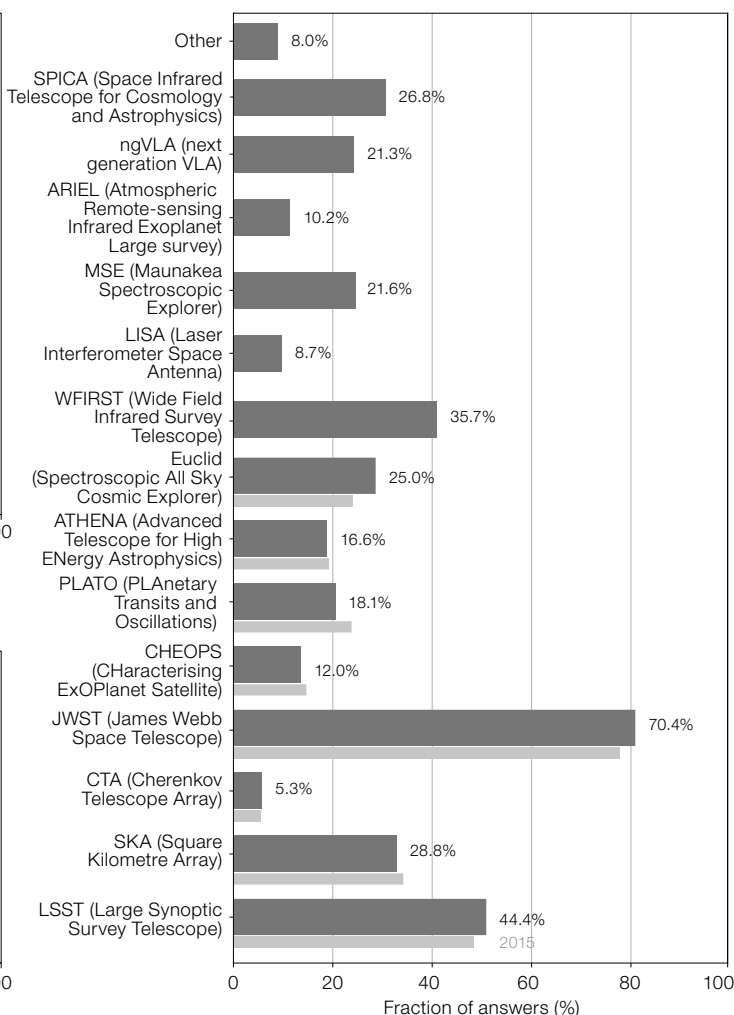

Which of these possible facilities do your future research objectives require?

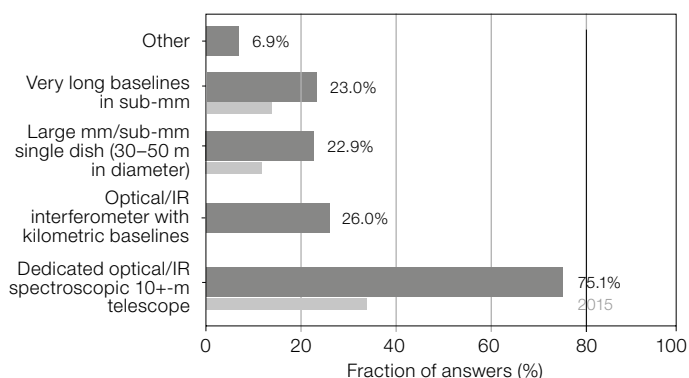

Figure 7. Importance of present and future (planned or not) facilities. The thinner and lighter grey bars show the numbers from the 2015 survey (where available).

missing from the current and planned offerings at ESO's VLT/I. Nearly a quarter of the respondents (399 or 24%) commented, most of them providing details of missing capabilities. Most answers suggest different telescopes (for example, smaller telescopes or 10-metre spectroscopic telescopes). In broad terms, the missing capabilities for the VLT are in the areas of multi-object spectrographs and integral-field units (99 answers), in the near-infrared, or concern adaptive optics at bluer wavelengths. Other popular requests are for VLT extended capabilities (48 answers), and polarimetric modes, either for spectroscopy or imaging (34 answers).

The next question concerned current observing modes and scheduling capabilities and which of those will be important for research objectives in the coming decade. The question is similar to one asked in 2015, but the numbers cannot be compared directly as the methodology was slightly different. However, we can make some interesting observations (see Figure 9):

- Normal Programmes and Service Mode have the most support (~90% find it very relevant or relevant). Public Surveys and Large Programmes also have significant support (~70%). Around half (40–60%) of the community found the other modes relevant.
- Visitor Mode is less favoured (55.5%) compared to service mode (88.9%). There is a generational trend: the youngest and most senior scientists

- tend to be more in favour of Visitor Mode than their mid-career peers.
- Visitor Mode and Delegated Visitor Mode^a have exactly the same level of support.
- Director's Discretionary Time (DDT) is found to be less relevant to students than to more senior researchers.

Regarding possible future operational capabilities, most ideas attracted a positive response (see Figure 10). The most favoured options are those bringing operations towards more virtual access: archival proposals, remote observations, cloud-based access to data and reduction tools. Many new features have generational trends. The ideas that are clearly preferred by younger researchers include distributed peer review, dual-anonymous proposals, the possibility of applying for several facil-

In June 2019 ESO organised a workshop to discuss future developments for VLT and VLTI in the 2030+ timeframe. Several projects were discussed and four projects were selected by the Science and Technical Committee (STC) for further review. Three of these projects have advanced design, whereas the fourth is only a concept, currently lacking a consortium. How relevant are the following projects for your research?

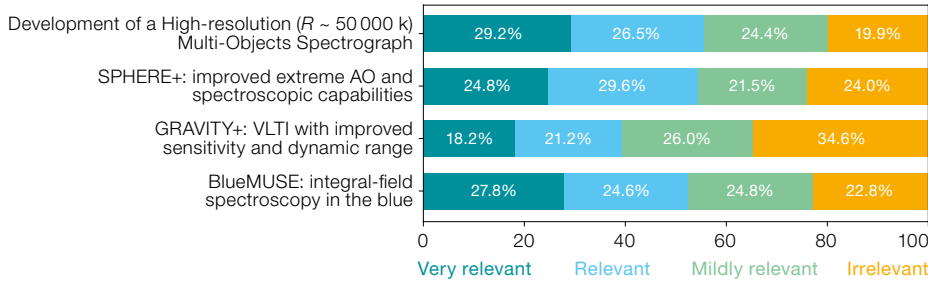

ities at once, and cloud-based access to data and pipelines. Only the capability for remote observations is less favoured by younger scientists; this trend was also seen in the level of enthusiasm for the Visitor Mode amongst more junior researchers.

Cross analysis: facilities versus research fields

Although the poll was fully anonymous we can match answers to one question with those to another, as we already did to analyse answers by career stage. For example, we can examine the desire for current and future facilities as a function of the research field the respondent works in.

Which of the current observing modes and scheduling capabilities will be important for your research objectives in the coming decade?

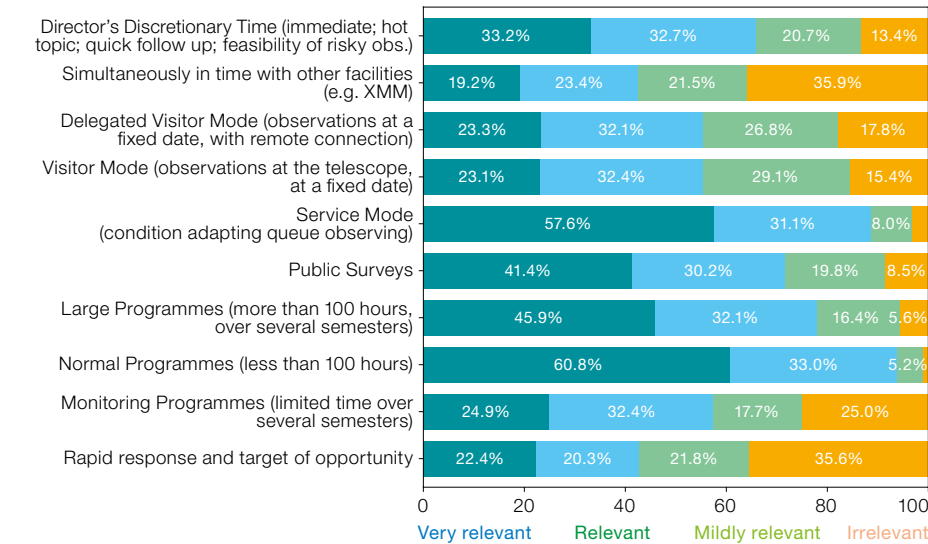

Figure 11 displays both coloured and tabulated values for the people finding current, planned or future projects “relevant” or “very relevant” for their research, broken down by community. The data are very rich, but a few broad conclusions can be drawn: the VLT, the ELT, the data archive and a future 10-metre spectroscopic telescope are considered to be true multi-purpose machines, since they are embraced by a large fraction of all communities. Other facilities are specialised in terms of the communities they serve, because of their excellence in spectral coverage, angular resolution, sensitivity, operational modes, etc. The most popular research area is “Structure and Evolution of Galaxies (including AGN)” with 733 respondents indicating that they work in this area. The facilities that these respondents would like to use for their future research closely match the overall outcome of the poll. The second-most popular research area is “Life Cycle of Stars”, where the optical telescopes (VLT and ELT) and the archive are mentioned as important facilities for future research, while the third-most popular research area “Life Cycle of Interstellar Matter” clearly benefits from having access to ALMA, which for these respondents is as important as the VLT to achieve their research goals.

How favourably do you consider the following possible capabilities?

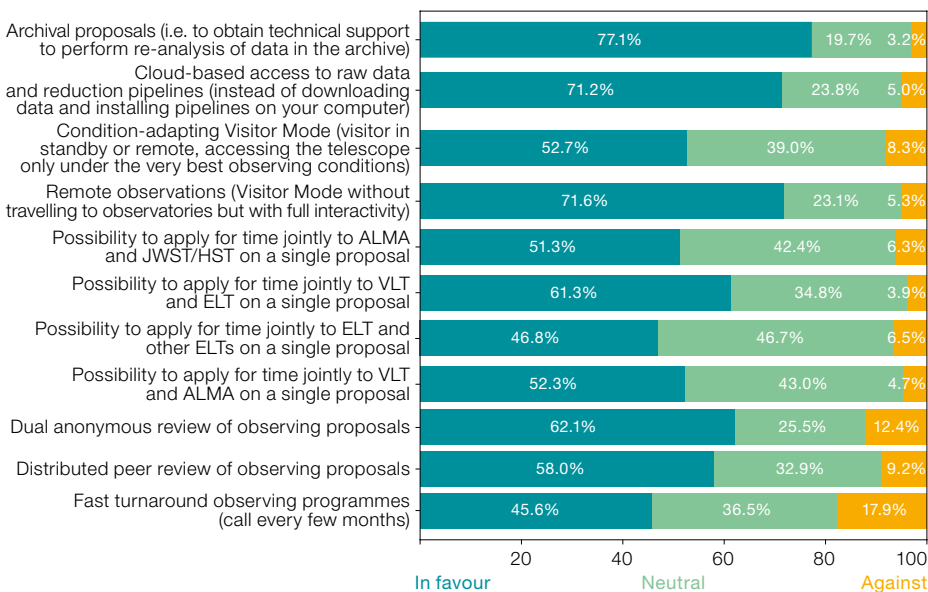

Figure 8. (Upper) Relevance of the VLT 2030+ instruments according to the poll respondents.

Figure 9. (Middle) The relevance to respondents' research of current observing modes and scheduling capabilities.

Figure 10. (Lower) Possible future capabilities.

What are your main areas of astrophysical research?

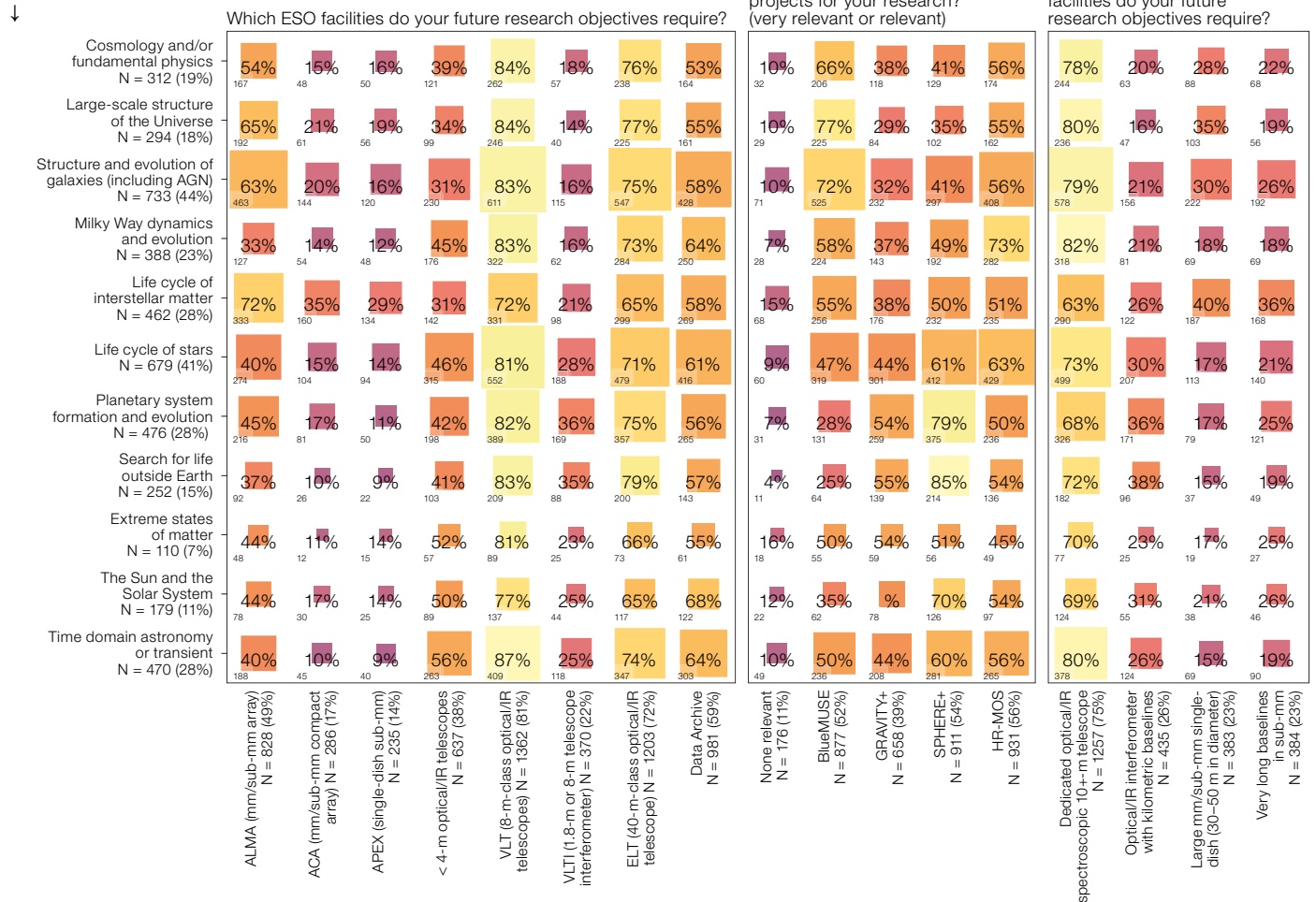

Figure 11. Interest in facilities, broken down by astrophysical fields. Facilities are in columns (current facilities to the left, VLT2030+ projects in the middle, future projects to the right). Percentages are computed by rows (research fields): for example, 72% (N = 333) of people working in “Life cycle of the interstellar matter” (N = 462) find ALMA relevant. Colours reflect the percentages, while coloured areas are proportional to the number of answers. For example, among all communities, “Life cycle of the interstellar matter” has the largest fractions interested in ALMA (333/462 = 72%), even though “Structure and evolution of Galaxies, inc. AGNs” attracts more people (463), but a smaller fraction of the community (463/733 = 63%).

Conclusion

The 2020 ESO community poll reached a diverse community spread across career stage, research field and wavelength regimes, revealing the broad use of and interest in ESO facilities. The respondents come from a pool of ESO and European ALMA portal users, with 76% coming from the former and 14% from the

latter. The final 10% of users in the pool have accounts in both portals. The respondents indicate a high demand for the VLT, ALMA and the data archive, as well as the ELT and future operational modes. This is testimony to the relevance of these facilities, and an indication that users are engaged in their long-term use. Most of the observational parameter space of future interest is served by existing and planned ESO facilities (Figure 6). Yet two useful windows in this parameter space not currently covered by ESO are apparent: high-resolution spectropolarimetry and high-resolution, high-angular-resolution (interferometry and high-contrast imaging) in the optical and near-infrared. There is broad interest in the three new instruments proposed at the VLT2030 workshop, as well as in a high-resolution multi-object spectrograph. The poll shows a strong demand for the data archive (which was added in

this poll but did not feature in the 2015 version), as well as for data-reduction support (Figure 10). Concerning future facilities, the broadest interest is in a dedicated spectroscopic telescope. In conclusion, the working group felt that the polled community values and demands the broad diversity of tools that ESO operates and strongly supports existing and planned ESO facilities.

References

Mérand, A. & Leibundgut, B. 2019, The Messenger, 177, 67
 Primas, F. et al. 2015, The Messenger, 161, 6

Notes

^a Designated Visitor Mode means that the astronomer connects remotely to the observatory, rather than visiting in person.



This lone antenna is part of the Atacama Large Millimeter/submillimeter Array (ALMA), a telescope that comprises 66 high-precision antennas spread out across the Chajnantor plateau, located high up in the Chilean Andes. In this image the spectacularly multi-coloured view of the sky above ALMA is in full display: green airglow hovers above the horizon, the Large Magellanic Cloud peeks out from behind the antenna, and the magnificent sprawl of the Milky Way stretches out overhead.

A Guide to ALMA Operations and Interactions with the Community

Martin Zwaan¹
 Evanthis Hatziminaoglou¹
 Francisca Kemper¹
 Leonardo Testi¹
 Elizabeth Humpreys^{1,2}
 Misato Fukagawa³
 Anthony Remijan⁴
 Andy Biggs¹
 María Díaz Trigo¹
 Fabrizia Guglielmetti¹
 Eelco van Kampen¹
 Luke Maud¹
 Anna Miotello¹
 Dirk Petry¹
 Gergö Popping¹
 Suzanna Randall¹
 Thomas Stanke¹
 Felix Stoehr¹

¹ ESO

² Joint ALMA Observatory, Santiago, Chile

³ National Astronomical Observatory of Japan, Tokyo, Japan

⁴ National Radio Astronomy Observatory, Charlottesville, USA

A primary goal of the Atacama Large Millimeter/submillimeter Array (ALMA) has always been to be a facility accessible to astronomers, radio-interferometry experts and non-experts alike. As a project, it is strongly committed to listening to its users and to utilising this input in decision making and priority setting. Feedback from the community often highlights the perceived complexity of ALMA's organisational structure and, by extension, a diffuse uncertainty around how to make users' voices heard. The aim of this article is to provide insight into the functioning of ALMA as an integrated observatory, with an emphasis on science and science operations. We present information on the ways the observatory communicates with the broader community, with a focus on the mechanisms by which the community can provide feedback to the project.

ALMA organisational structure

To set the scene, below we provide a very brief overview of ALMA's organisational structure. ALMA is a worldwide

partnership^a spread over four continents, in which the European partner is ESO, representing its Member States. The three executives that jointly operate ALMA are ESO, the AUI/National Radio Astronomy Observatory (NRAO) and the National Astronomical Observatory of Japan (NAOJ). On-site operations are executed by a shared team based in Chile headed by the Joint ALMA Observatory (JAO) Director and Deputy Director and jointly supported by the executives. In contrast, all off-site activities (related to science operations, maintenance, and development) are conducted regionally, with each executive providing services and support tailored to the needs of its regional community and following the regional processes.

As one of ESO's primary facilities, off-site ALMA operations are embedded in ESO's organisational structure, within the ESO ALMA Support Centre, a Division of the ESO Directorate of Operations, working closely with the ESO Directorates of Science and Engineering. The ALMA Support Centres in the three regions provide all interactions between the regional communities and ALMA and are responsible for the execution of the ensemble of regional activities related to ALMA operations. These activities are related to science operations, computing, engineering, development, and public outreach. The heads of the three regional ALMA Support Centres, together with the JAO Deputy Director, form the ALMA Management Team (AMT). The AMT is the forum in which any issues relating to the planning and management of ALMA operations are shared, discussed, coordinated and resolved. The ultimate authority over ALMA high-level principles and policies is the ALMA Board. As the overall ALMA governing body, it is the primary forum for interactions amongst, and decisions of, the three ALMA contracting parties.

The integrated teams

One of the main challenges to the smooth functioning of ALMA is the coordination between the JAO and the regions such that effective support of operations, maintenance, and development is ensured. To this end, for each major area an Integrated Team (IXT¹) was created and tasked with executing this coordination.

Currently, there are four global IXTs: Engineering, Computing, Science, and Science Operations. An IXT dedicated to the coordination of the major ALMA system upgrades, the Integrated Development Team, is in the process of being set up. Staff in the regions and in Chile are responsible for the full distributed effort towards the goals and tasks within each IXT.

Here we focus in particular on two IXTs. The first, the Integrated Science Operations Team, or ISOpT, is tasked with defining and optimising the end-to-end workflow of science operations, from proposal preparation to data reduction and user support. The team develops and implements policies governing global science operations and is responsible for delivering the full package of science operations tasks. The ultimate goal is to provide an effective, efficient and homogeneous global user experience in order to maximise high-quality and transformational science. The team also acts on issues that are raised through various channels, including ALMA staff from the ALMA Regional Centres (ARCs) and the JAO.

The management of each IXT within ALMA is composed of one member from the JAO and three from the regions. In the case of ISOpT, this means the head of the ALMA Department of Science Operations (DSO) at the JAO and the managers of the three ARCs. In the decision making process, ISOpT usually invites input from experts and aims to reach a unanimous decision amongst the members.

Practices related to proposal preparation/submission (Phase 1), programme preparation/execution (Phase 2), project tracking, data reduction, data delivery and user support at each of these steps are all explicitly under the remit of ISOpT. It also deals with innovative improvements to observing strategies, increased pipeline reliability, data processing issues and improvements. An optimal information flow to the science community regarding science operations is another priority, as is supporting the user community through the Helpdesk, face-to-face consultations, training events and community days. Staff across the three ARCs (and related ARC nodes) and the DSO jointly carry out these tasks.

The Integrated Science Team (IST) is formed of the three regional programme scientists and the observatory scientist. Responsibilities of the IST include advising ALMA on the scientific priorities for the ALMA Development Program and providing scientific support for this programme. The IST also monitors the scientific productivity of ALMA and proposes ways to improve it. It also organises the triennial international ALMA science conference, and supports the organisation of topical or regional scientific and development meetings.

ALMA Subsystems

A primary responsibility of ISOpT is to set requirements for science software subsystems used by the scientific community and ALMA staff, and to verify that this software meets the design specifications and scientific requirements. To this end, ISOpT interacts closely with the Integrated Computing Team (ICT) in the area of software development priorities, testing, and deployment. ISOpT also oversees the testing of these subsystems and preparation of end-user documentation.

For each software subsystem, a subsystem scientist, who is an expert on that subsystem at one of the ARCs or at the JAO, leads the formulation of the scientific requirements and priorities. It is of course essential that these priorities are aligned with the overall ALMA observatory priorities. To ensure that all ALMA regions are represented in the collection and prioritisation of requirements, the subsystem scientists are supported by working groups with members from all four regions. In general, consensus must be reached in the working groups before improvements or new feature requests are raised to the implementation phase.

Amongst the numerous subsystems, some are relatively invisible to the user community, such as internal tools to track observing projects and quality assurance or scheduling, and their requirements are defined through well-established procedures within the project. Others, such as the ALMA Observing Tool, the Snooping Project Interface (SnooPI), the Science Archive, the Science Portal and the Helpdesk, interact directly with the user community and welcome user feedback as an essential facet of setting requirements.

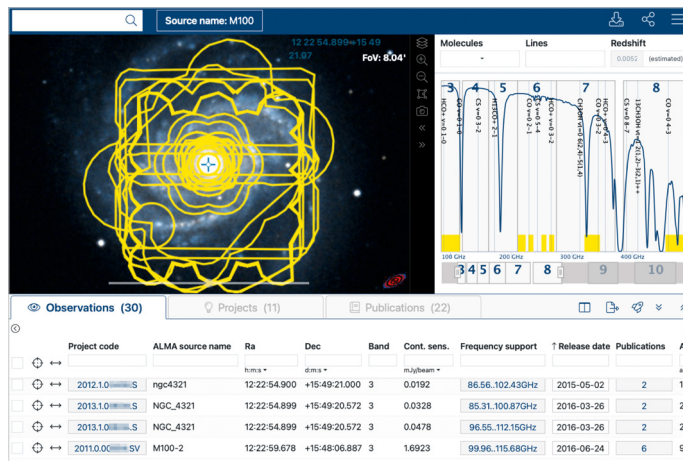

Figure 1. The redesigned ALMA Science Archive query interface provides access to all proprietary and public ALMA data.

Three of the subsystems listed as examples above are led from the ESO ARC. SnooPI is now a very mature system and is one of the main interfaces between the user community and the observatory. Principal Investigators (PIs) and Co-Investigators (Co-Is) can log into the tool to follow their ALMA projects from the moment of proposal submission all the way to data delivery, and they can download quality assurance reports. The ALMA Science Archive is developing very fast to meet user requirements. Some recent highlights include a completely redesigned query interface, the Cube Analysis and

Rendering Tool for Astronomy (CARTA) remote visualisation and the new ALMA virtual observatory (VO) services. Finally, the ALMA Observing Tool is being upgraded to a web-based application. The current desktop tool began development nearly twenty years ago and so the upgrade will also bring it up to date in terms of the technologies used, introducing both user enhancements and easier maintainability. It should be noted that the Observing Tool upgrade, upcoming ALMA Science Archive enhancements, and the Additional Representative Images for Legacy (ARI-L²) project, which produces homogeneous imaging products for Cycles 2 to 4, are all possible thanks to the ALMA Development Program³.

Department of Science Operations

Although ISOpT is overseeing the overall global ALMA science operations, it is

Department of Science Operations

Although ISOpT is overseeing the overall global ALMA science operations, it is

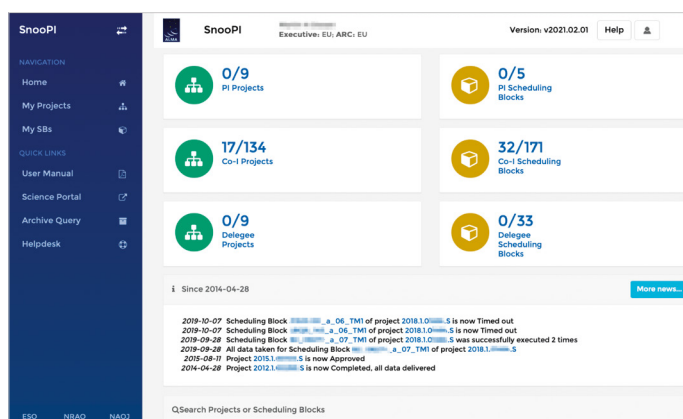

Figure 2. SnooPI allows PIs, Co-Is and Delegates to track the observational and processing status of their ALMA science projects.

important to clarify that many of the tasks within science operations are the explicit responsibility of the DSO at the JAO. This department is directly responsible for the day-to-day science operations at the telescope, including the execution of the science projects, but also troubleshoots issues with the ALMA array, acquires and processes test data, performs trend analysis of the array performance, and coordinates quality assurance. Issues related to antenna availability, configuration details (pad availability, the relocation schedule) are also within the purview of the DSO. Staff within the DSO are responsible for most of the astronomer-on-duty shifts, augmented by visits from ARC astronomers. The yearly process that makes new observing capabilities possible — known as ObsMode — is also led and coordinated by the DSO (Takahashi et al., 2021).

ALMA Regional Centres

Within the regions, ALMA science operations are organised at the ARCs. In addition to hosting a subset of the subsystem scientists, the ARCs are responsible for user support in their regions and work closely together with their colleagues in Chile and the other ARCs to deliver the science operations programme.

The ARCs also host complete mirrored copies of the ALMA Science Archive, one additional copy of which is located in Chile. It contains all raw science target and calibration data, all data products produced by the ALMA Pipeline or by manual data reduction, and quality assurance parameters. Externally contributed products (for example, from Large Programmes) will also be available in the near future. The ARCs contribute to documentation, deliver call-for-proposal and observation preparation support, and assist with enabling new capabilities (see Maud et al., 2021). Data processing and quality assurance (see Petry et al., 2020) constitute a major task as well, in addition to Helpdesk staffing.

In Europe, the ARC is uniquely organised as a distributed structure, where, in addition to the ARC department at the ESO headquarters, seven nodes throughout Europe provide enhanced services to

ALMA users. The face-to-face user support, one of the backbones of ALMA's user support structure, is fully delegated to the nodes in the ARC network. European users can receive face-to-face or virtual help from ALMA experts at each of the seven nodes. The functioning of this network is explained in detail by Hatziminaoglou et al. (2015).

One particular priority of the ESO ARC is to identify synergies with departments responsible for user support and science operations at ESO's other facilities. For example, the ALMA Helpdesk has migrated to the new service provider Deskpro. This same tool is now also employed for La Silla Paranal, which means that all ESO users will have a uniform user experience when creating tickets and interacting with support staff.

As another example, ALMA data products have now been integrated into the ESO Archive Science Portal along with data products from the ESO's other facilities. Millions of datasets can be browsed jointly through a uniform set of query items, providing a unique integrated panchromatic view of the southern hemisphere, extending from the near-ultraviolet to millimetre wavelengths. The selected data can then be downloaded from the respective portals for ALMA and ESO.

From the community to the project

ALMA is very much committed to nurturing an optimal two-way communication with its users. News from the observatory is posted on the ALMA Science Portal⁴, and in Europe this information, as well as additional ALMA news relevant to the European community, is disseminated through a newsletter⁵ that is distributed to all European ALMA users. Furthermore, most of the European ARC nodes maintain their own regional newsletters. Everything our users need to be aware of, for example information related to calls for observing proposals, data reduction, community events, and developments in capabilities, is shared through these channels, as well as via the various social media accounts.

Equally important though, is that ISOPT is fully aware of its users' needs and wishes and is in touch with what the community considers important to reach their scientific goals (see Figure 3). The front-line channel for all feedback to ALMA is the Helpdesk, although in reality most information that comes to ALMA through this channel is directly related to observing programmes, for example status of observations, requests for help with data reduction. Another very important channel is provided by advisory committees, through which the community can make its voice heard on topics

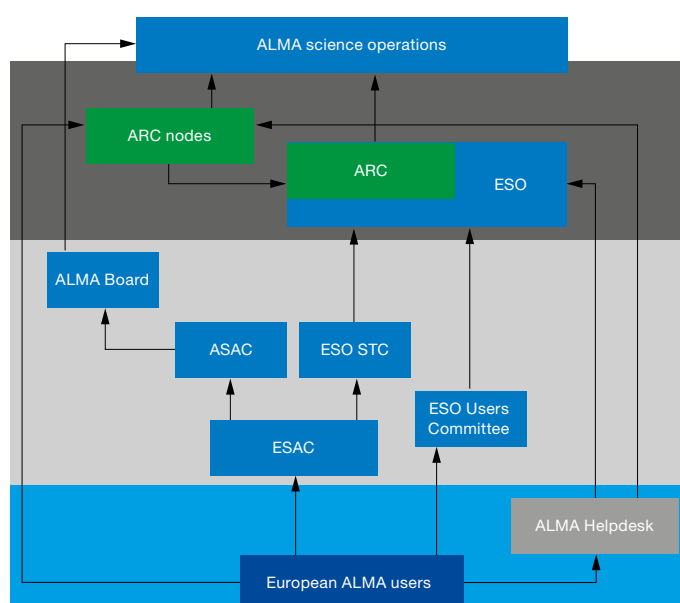

Figure 3. An illustration of how community input can reach ALMA science operations. European ALMA users can submit Helpdesk tickets, contact their ESAC or UC representatives, or communicate directly with the ARC nodes.

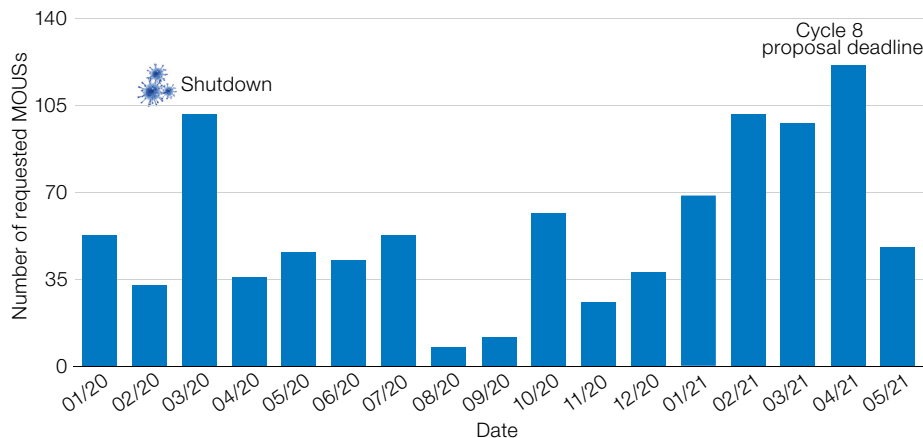

Figure 4. The number of member observing unit sets (MOUSs) that the ESO ARC delivers through its calibrated data set service, as a function of time.

related to operations, science priorities, enhancements and future development.

The European Science Advisory Committee (ESAC), a subcommittee of the Scientific Technical Committee (STC), is tasked with advising ESO on all technical and scientific matters related to ALMA. The ESAC members, all of whom are representatives of the European ALMA science community, are appointed by ESO, typically for a period of three years. The ESAC is coordinated by the European ALMA Programme Scientist, who interfaces between the committee and the ALMA activities at ESO. Counterparts of the ESAC exist also in North America and East Asia, and representatives of all these three regional committees have seats on the ALMA Science Advisory Committee (ASAC⁶), which, in turn, advises the ALMA Board. The ALMA observatory scientist coordinates the ASAC and interfaces between the ASAC and the JAO. Each of the members of the ESAC⁷, as well as the European ALMA Programme Scientist, can be contacted at any time in relation to ALMA development and science matters.

European ALMA users have yet another channel through which to have their say in ALMA priorities and directions. The ESO Users Committee (UC⁸; see also Cioni, 2019) is an advisory body that represents active European users of the La Silla Paranal Observatory, including the Atacama Pathfinder EXperiment (APEX), and ALMA. Its members are appointed for a three-year term and encompass a

broad range of scientific competences. As an example of the recommendations that are formulated, following signals from the community, the UC made a strong recommendation to ESO to implement a service that provides access to ALMA calibrated measurement sets for archive users and PIs. The ESO ARC followed up on this recommendation and implemented this service, which is now a very popular and welcome addition to the suite of services it offers (see Figure 4).

ALMA is constantly seeking out new ways of receiving feedback from, and engaging with, its user community. The latest such effort is the ongoing Re-defining the User eXperience (RedUX), a series of interviews with individual ALMA users that expressed their interest in participating, following a call for volunteers in the autumn of 2020 sent to ALMA users world-wide. The aim of this exercise is to take a holistic view of the ALMA user experience, identify issues and implement innovative solutions, in an effort to further enable high-impact science with ALMA.

Concluding remarks

ALMA is a unique project in the astronomical landscape, a large collaboration of diverse institutes and cultures, all bringing together the best of their worlds. In order to achieve one of its primary goals, i.e. the accessibility of the facility to all astronomers, regardless of their expertise, ALMA is committed to engag-

ing with its user community. This article has given an overview of ALMA's organisational structure, its functioning as an integrated observatory and the different channels available to the European ALMA users to provide their feedback and make themselves heard, helping to keep ALMA at the forefront of astronomical research.

References

- Cioni, M. et al. 2019, *The Messenger*, 176, 8
- Hatziminaoglou, E. et al. 2015, *The Messenger*, 162, 24
- Maud, L. et al. 2021, *The Messenger*, 183, 13
- Petry, D. et al. 2020, *The Messenger*, 181, 16
- Takahashi, S. et al. 2021, *ALMA Memo*, 618

Links

- ¹ The ALMA management structure: <https://www.almaobservatory.org/en/about-almathe-people/alma-management/>
- ² The ARI-L project: <https://almascience.eso.org/alma-data/aril>
- ³ The ALMA Development Program: <https://www.almaobservatory.org/wp-content/uploads/2018/07/20180712-almadevelopment-roadmap.pdf>
- ⁴ The ALMA Science Portal: <http://almascience.org>
- ⁵ The European ARC newsletter: <https://www.eso.org/sci/facilities/alm/news/arc-newsletter.html>
- ⁶ ASAC members: <https://www.almaobservatory.org/en/about-almathe-people/the-almacommittees/asac-members-list/>
- ⁷ ESAC members: <https://www.eso.org/public/about-eso/committees/stc-esac/stc-esac2021.html>
- ⁸ ESO Users Committee: <https://www.eso.org/public/about-eso/committees/uc/uc2021.html>

Notes

- ^a ALMA is a partnership of ESO (representing its Member States), the National Science Foundation in the USA and the National Institutes of Natural Sciences in Japan, together with the National Research Council (Canada), the Ministry of Science and Technology and the Academia Sinica Institute of Astronomy and Astrophysics (Taiwan) and the Korea Astronomy and Space Science Institute (Republic of Korea), in cooperation with the Republic of Chile.

Upgrade Strategies for the ALMA Digital System

Benjamin Quertier¹
 Stéphane Gauffre¹
 Antsa Randriamantena¹
 Marina Studniarek¹
 Carlos De Breuck²
 Tony Mroczkowski²
 Gie Han Tan²
 Ciska Kemper²
 Neil Phillips²

¹ LAB, University of Bordeaux, France

² ESO

The Atacama Large Millimeter/submillimeter Array (ALMA) comprises 66 antennas working as a powerful interferometer. High-speed digitisation, signal transmission over several tens of kilometres from the receivers to the correlator, and complex data processing all require state-of-the-art technologies. The ALMA2030 Development Roadmap calls for an increase in the bandwidth by at least a factor of two, implying a major upgrade of the entire signal path. We present here the results of a detailed study looking at how to upgrade the ALMA digital system, including digitisation, data pre-processing, and data transmission to cope with bandwidths more than four times the current ones. At the same time, this system will contribute to increasing the nominal correlation efficiency from 88% to 99%, and prepare ALMA for longer baselines of up to 100 kilometres.

Introduction

ALMA is by far the most powerful (sub-) millimetre interferometer ever built, and has produced transformational science results throughout its first decade of opera-

tion (see, for example, Kemper, 2020). Bringing the signals from up to 66 antennas together in the correlators was one of the major technological challenges of ALMA. It involved laying more than 1000 kilometres of fibres between the 212 antenna pads and the correlator located in the Array Operations Site (AOS) technical building at an elevation of 5100 metres. During the construction phase, the University of Bordeaux (UB) was responsible for delivering two subsystems: the digitiser and the Tunable Filter Bank (TFB).

The digitiser module was built on two application-specific integrated circuits (ASICs), a 3-bit analogue-to-digital converter (ADC) and a demultiplexer, designed by UB with a bipolar complementary metal-oxide-semiconductor (BiCMOS) technology from ST-Microelectronics (see Baudry et al., 2006). This module performs the signal digitisation in the 2–4 GHz intermediate frequency (IF) bands^a of two polarisations resulting from the first and second analogue frequency conversions, with the digitisers sampling in the second Nyquist zone. The receiver usually produces an IF of 8 GHz, so each antenna is equipped with four digitisation modules.

The TFB, part of the correlator, is a digital electronic system based on field-programmable gate array (FPGA) technology, clocked at 125 MHz, that performs massively parallel data processing. Each TFB card can process one of the 2-GHz basebands generated by the digitiser module to extract up to 32 subbands of 62.5 or 31.25 MHz, on which the correlation is performed. The TFB implements a spectral selection and zoom effect, and increases the total number of spectral channels produced by the correlator by a factor of 30 (7680 per

baseband compared to 256 without the use of the TFBs).

Whilst ALMA inspired major progress in (sub-)millimetre technology during its construction phase, other (sub-)millimetre telescopes have also benefitted from these advances and have since overtaken ALMA, especially in terms of the instantaneous bandwidth that can be observed. To keep ALMA at the forefront of science and technology, the ALMA2030 Development Roadmap (Carpenter et al., 2019) both defined new key science drivers and prioritised increasing the overall instantaneous bandwidth of ALMA by a factor of at least two (but preferably four). This entails increasing the IF bandwidth of the receivers and the associated electronics and correlator. With these improvements, ALMA will be 2–4 times faster for spectral line surveys such as those required to study the chemical complexity in star-forming regions, but also when it is used as a redshift machine (see, for example, Reuter et al., 2020). All continuum projects will at the same time benefit from the improved sensitivity and imaging fidelity that comes with such a dramatic increase in bandwidth.

Such a major upgrade is of course more complex for an interferometer with as many as 66 antennas. Whilst most of the development efforts have thus far concentrated on completing the original receiver complement, this effort will come to an end in a few years now that the final receiver (Band 2) is on track to be built by an international consortium led by ESO (Yagoubov et al., 2020). This allows ALMA to now take on the ALMA2030 bandwidth upgrade, involving receivers, digitisers and the correlator. During the last decade, the Laboratoire d'Astrophysique de Bordeaux (LAB) has completed a set of

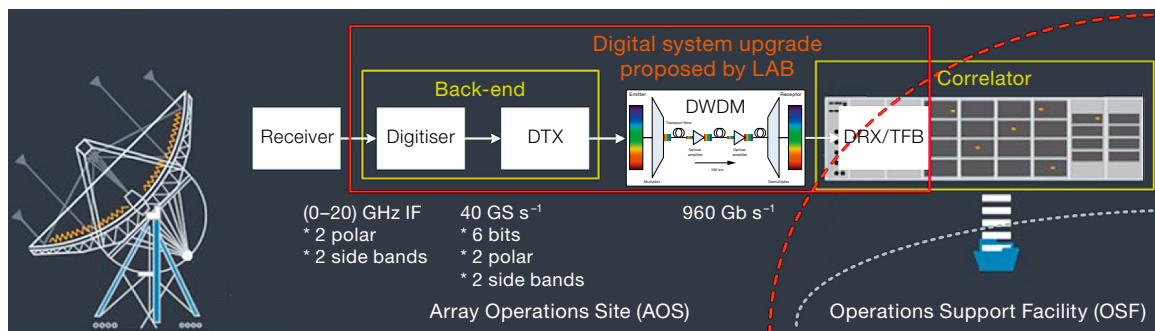

Figure 1. Upgrade of the digital system as proposed by the LAB, University of Bordeaux (both AOS and OSF locations are considered for the new correlator).

development studies supported by ESO to identify appropriate solutions for the digitiser, digital signal processing and data transport that enable meeting these ambitious new goals. In addition to the bandwidth extension, the more modern ADCs also allow one to increase the nominal correlation efficiency from the current 88% to almost 99%, which in terms of sensitivity is equivalent to adding 6–8 new antennas to the array, even for single-line observations. The advanced digitiser solutions studied by the LAB match well the aims of the future ALMA system architecture using only a single, very wide-band IF stage instead of the dual heterodyne conversion approach currently in use.

This single frequency conversion architecture has several major advantages for the user:

- There is no loss of instantaneous bandwidth arising from the use of multiple, staggered, non-ideal IF pass bands. In the current system 4 adjacent bands of 2 GHz each are used; however, the effective total bandwidth is only 7.5 GHz.
- The lack of discontinuities in the band-pass curves of adjacent filters, since the whole IF range will be covered by one passband, makes calibration for this anomaly redundant.
- There is no longer a need for oscillators to convert the astronomical signal from the IF_1 range to the IF_2 range. In practice these strong oscillator signals produce unwanted spurious, ghost signals in the astronomical observations.

The main objective of the first LAB study in 2013 was to evaluate technologies which could be used within a ten-year timeframe to upgrade the sub-systems originally delivered by the LAB. The second study performed by the LAB was focused on the identification and the evaluation of the critical devices required to upgrade digitisation, data transmission, and digital signal processing, in accordance with the general ALMA2030 roadmap, which had been progressively defined in the meanwhile. This second study also included system architecture considerations and comparisons. The most recent LAB study, which is ending in June 2021, aims to confirm these critical choices regarding the ALMA2030 specifications which are now available. All three studies focus on upgrading the

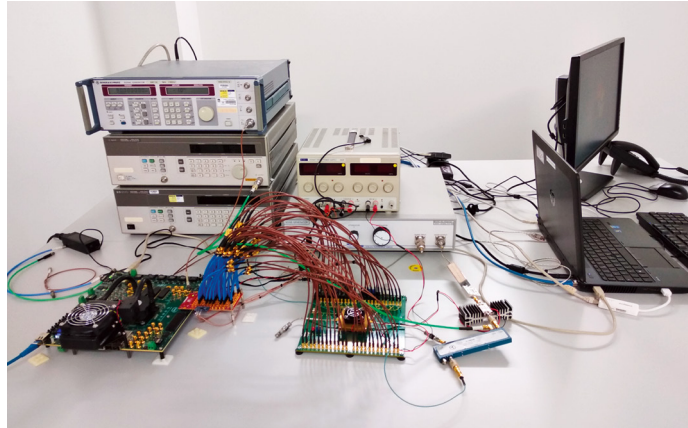

Figure 2. Test bench of the Micram digitiser module in the technical facility at the LAB, University of Bordeaux. The digitiser performance is measured at 40 GS s^{-1} using the Intel Stratix 10 GX FPGA development kit.

ALMA digital system, from digitisation to correlation (see Figure 1).

Digitisation

Digitisation is one of the main technological challenges in respect of increasing the ALMA instantaneous bandwidth because the market for ADCs with analogue bandwidths and sampling frequencies above 10 GHz is extremely small and unsteady. For the past ten years the electronics group at the LAB has been investigating homemade fully custom ASIC solutions, based on CMOS or BiCMOS technologies, continuing the development work it undertook for the construction phase, and has in parallel carried out an ongoing survey of the solutions announced or under development by small microelectronics startups and global electronics companies. Several of the most promising solutions have been evaluated in the laboratory to measure their actual performance and assess the complexity of their implementation and potential use for ALMA. Various digitisation topologies (for example, multi-rate, interleaved) have also been considered to achieve digitisation of a bandwidth larger than half the sampling frequency, the limit given by the Shannon sampling theorem (see, for example, Tan & Jiang, 2019).

Our primary objective has always been to design a digital back-end including the digitisation, data transmission, and possibly some digital signal processing functions, which would be able to digitise the full IF bandwidth delivered by the new generation of receivers and format the digital samples for transmission over opti-

cal fibre. Removing most of the analogue parts, currently used for the second frequency conversion prior to digitisation, we would enhance back-end versatility, reproducibility and reliability, and ease calibration and failure analysis.

Today the baseline solution for the ALMA2030 digitisation is an ADC module from Micram Microelectronic GmbH. This commercial device was initially specified for 34 GS s^{-1} , but has been extensively evaluated by the LAB group up to 40 GS s^{-1} , and subsequently also by Micram. The Micram digitiser chip is built on two internally interleaved ADC cores. Complex calibration is required to optimise the linearity of each core and minimise the mismatch between cores. With this solution we can achieve direct digitisation of, for example, 2–19.5 GHz IF at 40 GS s^{-1} , ten times better than the current digitiser, and we also significantly increase the quantisation efficiency since the Micram device is a 6-bit ADC (as against 3 bits for the current digitiser).

Digitiser requirements

The requirements that drive the selection of the digitiser are the sampling frequency, the bandwidth and the quantisation efficiency. Indeed, the maximal sampling frequency (combined with the digitisation topology adopted) and the digitiser bandwidth together define the effective IF band which can be digitised, and thus the instrument's instantaneous bandwidth. Moreover, the quantisation efficiency is a direct contributor to the overall instrument sensitivity. If the question of the bandwidth and sampling frequency is relatively straightforward, the question

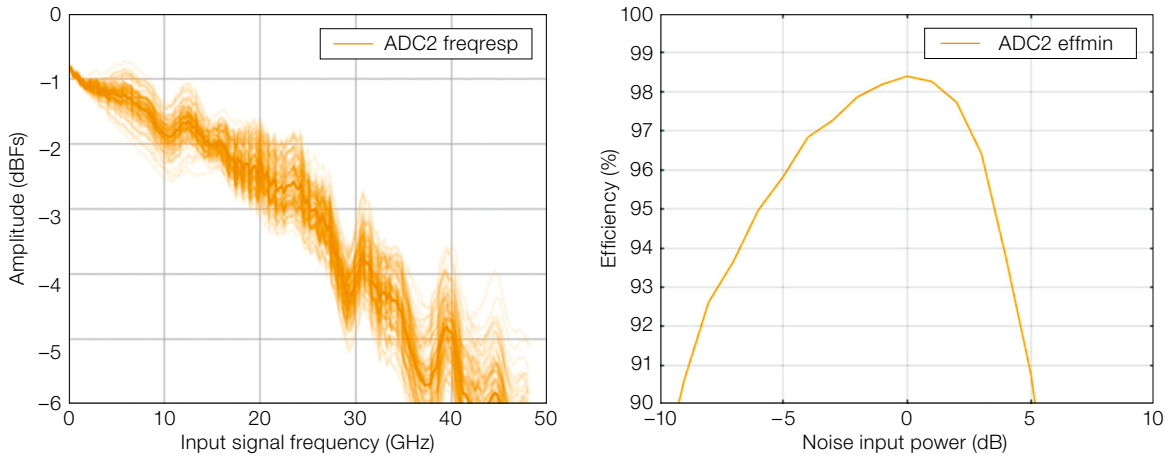

Figure 3. The Micram digitiser’s bandwidth (measured using a sine wave input; note that only frequencies below 20 GHz would be used when sampling the first Nyquist zone at 40 GS s⁻¹) and quantisation efficiency (measured using a Gaussian noise input that includes a passband gain variation of 5.4 dB over 16 GHz).

of the quantisation efficiency, and how to define and measure it, is much more complex.

Quantisation efficiency is the relative loss in signal-to-noise ratio (SNR) resulting from the quantisation process; it depends on the number of quantisation levels and the statistical property of the input signal. Thompson, Emerson & Schwab (2007) provide a method for calculating the quantisation efficiency for any number of uniformly spaced levels as a function of the level spacing, using mathematical formulas with radio-astronomy-like signal (Gaussian for a perfect ADC). The deviation from the ideal quantisation step width, which necessarily exists with a real ADC because of manufacturing imperfections, is called differential nonlinearity. Appropriate calibration is needed to minimise this nonlinearity, but some degradation of the quantisation efficiency is unavoidable. In our latest study we describe a novel approach which consists of estimating the effective quantisation efficiency of a real

ADC from SNR measurements instead of over-constraining the digitiser specification using the effective number of bits (ENOB) as is often suggested. Indeed, it would be particularly unfortunate to be mistaken in the digitiser evaluation and selection process, considering that there are very few candidates that are capable of achieving the ALMA2030 objectives.

Performance of the Micram solution

We ran four test campaigns with the Micram device over the past 3 years. The first two were held at the Micram facility and allowed us to measure the general performance, the stability over time and the temperature of the digitiser module operating at 34 GS s⁻¹, on noise signals. Two additional test campaigns were then undertaken in the LAB technical facility (see Figure 2), based on our own digital signal processing and calibration procedures, when we were able to demonstrate the performance up to 40 GS s⁻¹. This was later confirmed by Micram on a sam-

ple of 100 devices. It was also demonstrated that the bandwidth at 40 GS s⁻¹ is beyond 20 GHz (see Figure 3), that the digital sample capture and synchronisation with an FPGA was suitable for long-term applications, that the mismatch calibration process of the two cores appears efficient at rejecting the ghost image arising from interleaving below the quantisation noise floor, and that the threshold response estimated from Gaussian noise histograms makes it possible to optimise the ADC linearity for radio astronomy. Finally, we have been able to estimate the quantisation efficiency from SNR measurements at around 98% for standard astronomical observations (passband gain variations < 5.4 dB over 16 GHz and signal level changes ≤ 4 dB).

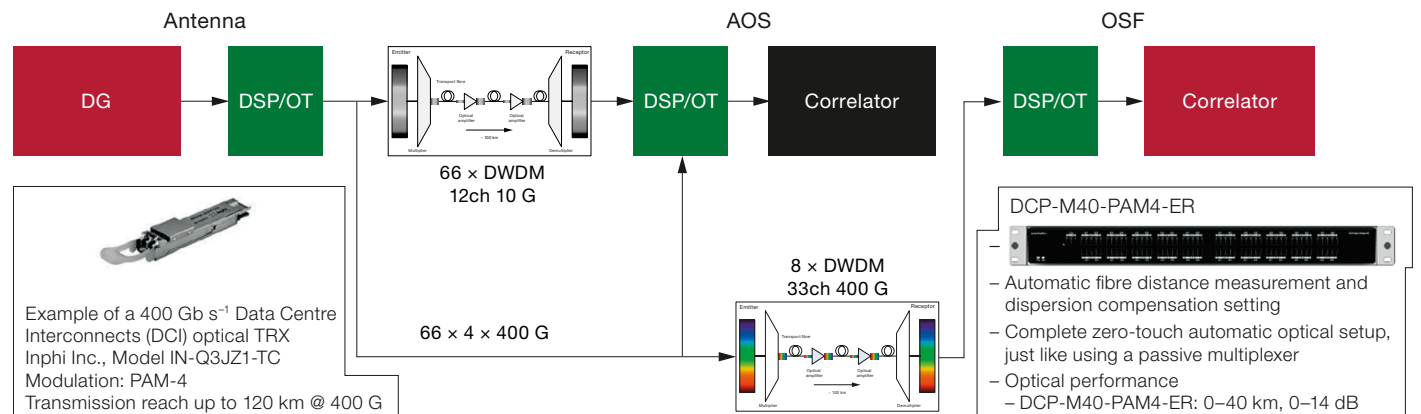

Figure 4. Possible data transmission scheme from antennas to correlator (both AOS and OSF locations are considered).

Digital data pre-processing and data transmission

The antennas are connected to the AOS technical building by a network of optical fibre cables. Each antenna is connected by eight single-mode optical fibres, allocated as follows: one fibre for the Data Transmission System, one fibre for the Photonic Local Oscillator and low-frequency timing references, two fibres for the monitoring and control communication, and four spare fibres. The data flow generated by each antenna is transmitted over a single optical fibre using wavelength division multiplexing, a technology which multiplexes a number of optical carrier signals onto a single optical fibre by using different wavelengths (i.e., colours) of laser light. The current system is based on 20-channel dense wavelength division multiplexing (DWDM) with 10 G per channel, where only 12 channels are populated. The current throughput of 120 Gb s⁻¹ per antenna could then be increased to 200 Gb s⁻¹, but this would not in any case be sufficient to support the IF bandwidth doubling that is a minimum objective for ALMA 2030.

The location of the new-generation correlator will almost certainly be at the Operation Support Facility (OSF) and no longer at the AOS building. This preference has been expressed by several key stakeholders over the past years, for example at the ALMA 2030 workshops organised by the US National Radio Astronomy Observatory (NRAO) and the National Astronomical Observatory of Japan (NAOJ) in 2020. For the upgrade design there is a near consensus within the ALMA developer community that the FFX architecture (where the first F indicates a frequency division of the signal, the second F stands for a Fourier transform stage and the X represents the cross-correlation stage of the signal processing) would be preferred, considering the possibilities offered by the wide multipliers in digital signal processing (DSP) hardware such as FPGA and the finest spectral resolution target of 1 kHz. Baudry et al. (2017) give several examples of high-spectral-resolution architecture where a frequency division of the input baseband is followed by a pure FX correlator. This pre-processing, often just called “the 1st F” in the DSP architecture, has been extensively investi-

gated by the LAB group over the past 5 years, in order to propose an upgrade to our initial contribution with the TFB. Note that the current baseline correlator architecture is a digital hybrid XF design (or FXF). However, when frequency division of the input baseband is bypassed, then the correlator behaves as a pure XF system; both operating modes (frequency-division mode and time-division mode) are offered to users. This brings greater flexibility and makes it possible to have an independent zooming factor within different spectral windows (a tradeoff between effective bandwidth and spectral resolution).

Data transport from antenna to OSF via AOS

One of the ALMA2030 priorities gets implemented by having extended baselines. The cable length to such remote new antenna pads may be significantly longer than the baseline length to the AOS, so lengths of 50 or even 60 kilometres cannot be excluded at this point. The 400G ZR data centre interconnects (DCI) technology allows for transmission reach up to 120 kilometres. The Inphi Corporation, a leader in high-speed data movement interconnects, announced in March 2021 the commercial availability and production ramp-up of COLORZ II 400ZR, the industry’s first quad small-form pluggable double-density coherent transceivers for cloud DCIs. It would be the perfect solution for the antenna-to-AOS links. The distance between the AOS and the OSF is less than 40 kilometres. 48 single-mode optical fibres are available for this connection. Installing additional fibres might not be possible so we have identified a fully commercial solution for a complete 40-channel multiplex/demultiplex DWDM module compatible with 1/10/40/100/200/400G Ethernet. Eight of these modules would increase the ALMA optical transport capacity to 2 Tb s⁻¹ per antenna, while using only eight single-mode fibres. This solution, combined with 400G ZR transceivers, allows for antenna-to-AOS distances of up to 80 kilometres.

Generic board DSP/optical transmission for the “1st F” and data transmission

For ALMA2030, state-of-the-art FPGAs are required at both ends of the optical fibre,

because at each stage we need many high-speed FPGA transceivers to capture, transmit, and receive the extended data flow. Since this kind of FPGA will necessarily come with a very large number of computational resources, we can consider various partitioning configurations of the overall signal processing between the antenna, the AOS and the OSF buildings in order to minimise the cost, ease the deployment, and increase the versatility of the system. For example, the pre-processing and data transmission functions of the current system could be merged in a single FPGA. Moreover, having a first DSP stage like a frequency division at the antenna would be the most straightforward strategy to transmit the overall data stream over the optical system because of considerations concerning the detailed electrical interface of the transceivers and impacts on frame synchronisation. Figure 5 gives an overview of one of the possible architectures we have identified to perform the frequency division prior to the correlation. Here, over-sampled polyphase filter banks are used to provide the ability to switch between time-division mode and frequency-division mode while keeping the same usable bandwidth and throughput. One important conclusion is that the transceiver requirements and DSP partitioning are compatible with the idea of a generic FPGA board (DSP/OT, as seen in Figure 4) that could be used at both ends of the optical data transmission system, to implement various functions required along the data path. The only differences would be the firmware to be implemented in the generic FPGA board. This would be a tremendous advantage in terms of validation, manufacturing, fault analysis and maintenance. Using these FPGAs to perform the 1st F, at either end of the DTS link, rather than having additional FPGAs in the correlator for this task, could considerably improve the cost and power efficiency of ALMA2030.

Outlook: prototyping and on-site demonstration

Our current plan for this upgrade is described by the global block diagram in Figure 6, with on-site demonstration in potentially three steps to ensure compatibility with the existing infrastructure (physical locations, power supplies, reference

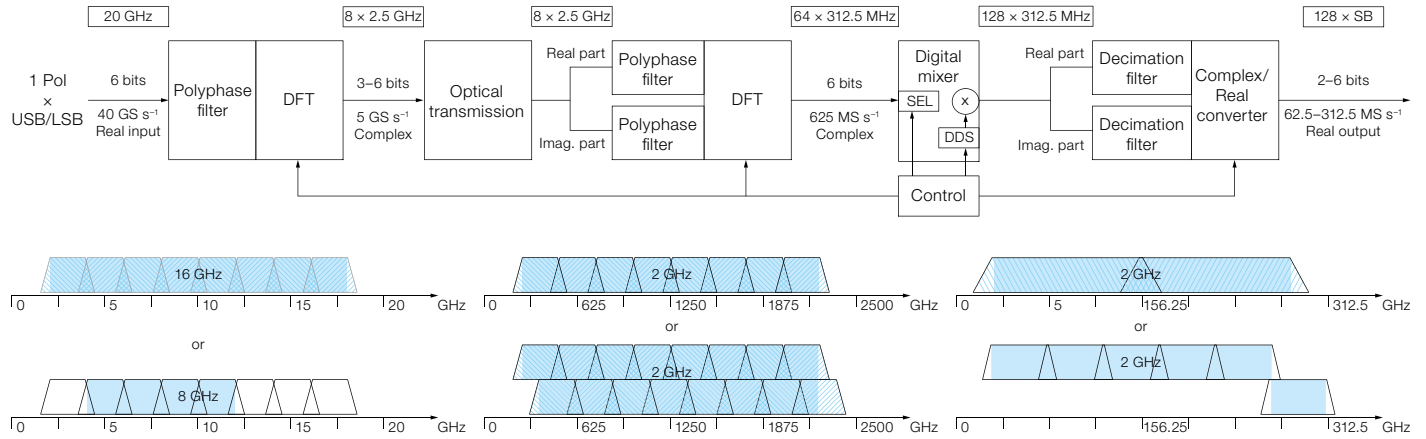

Figure 5. (Above) Example of DSP architecture.

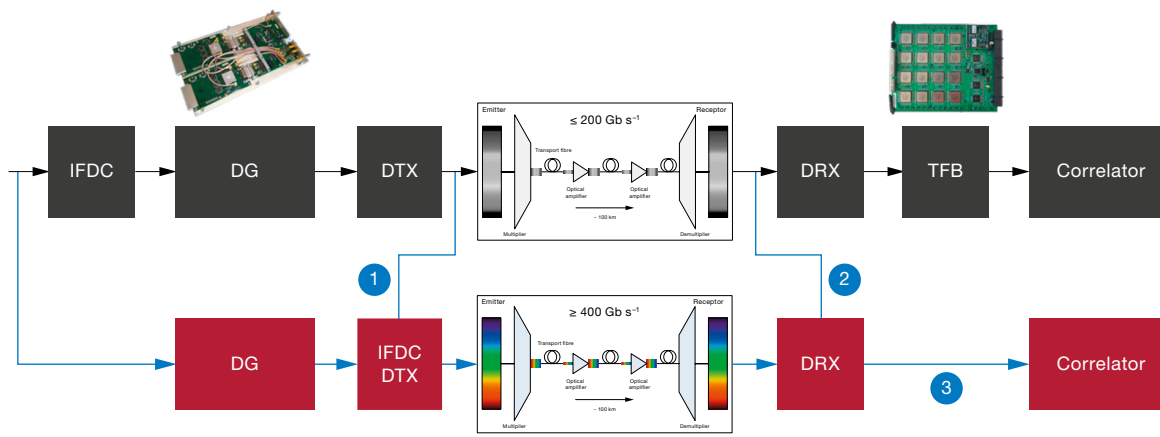

Figure 6. (Left) In black: the current system showing the digitizer module and the Tunable Filter Bank, two sub-systems of the ALMA instrument designed and delivered by the LAB, University of Bordeaux.; In colour: the digital system upgrade plans proposed by the LAB, Université de Bordeaux, with on-site demonstration in three potential steps before a full production and integration.

Step	Quantisation	Efficiency	Bandwidth	Spectral coverage
#1	3 bits × 2 bits	0.84	2 × 4 GHz/pol	128 × 62.5 MHz/pol
#12	6 bits × 2 bits	0.88	2 × 16 GHz/pol	128 × 62.5 MHz/pol
#13	6 bits × 6 bits	0.99	2 × 16 GHz/pol	256 × 125 MHz/pol

signals, control and monitoring interfaces and optical fibres) before a full production and integration. The recommended strategy is to deploy the new ALMA 2030 digital system in parallel with existing hardware, with all new components installed at different physical locations, so that the current system can continue science operations until the new system is commissioned. The bulk of commissioning could then be accomplished during periods of unfavourable or less favourable observing conditions (i.e., in daytime), while science operations continue with the current system during optimal conditions.

Acknowledgements

We would like to acknowledge the Micram and Intel companies for their technical support and various hardware loan agreements which made this work possible.

References

Kemper, C. 2020, *The Messenger*, 180, 42
 Baudry, A. et al. 2006, *The Messenger*, 125, 37
 Baudry, A. et al. 2017, ALMA Memo, 607
 Carpenter, J. et al. 2019, *The ALMA Development Roadmap*, arXiv:1902.02856
 Reuter, C. et al. 2020, *ApJ*, 902, 78
 Yagoubov, P. et al. 2020, *A&A*, 634, A46

Tan, L. & Jiang, J. 2019, *Digital Signal Processing*, (Cambridge, Massachusetts: Academic Press), 13 et seq.
 Thompson, A. R., Emerson, D. T. & Schwab, F. R. 2007, *Radio Science*, 42

Notes

^a The term “IF band” is used to distinguish the on-sky, radio frequency (RF) band (in the 35–950 GHz range for ALMA) from that accessible to the digitisation electronics (typically < 20 GHz).

This quartet of galaxies makes up the Hickson Compact Group HCG 86. It was observed with ESO's VLT Survey Telescope (VST) as part of the VST Early-type Galaxy Survey (VEGAS) large programme. Because of their compactness, such groups are ideal environments to study galactic interactions, which can sometimes lead to galaxies merging with each other. Not all bright objects in this image belong to HCG 86. The four members of HCG 86 are seen from Earth as arranged in triangular shape, with three of them on a straight line and one to the left; the bright objects below of the elongated galaxy are not part of the quartet.

The INvestigate Stellar Population In RELics (INSPIRE) Project — Scientific Goals and Survey Design

Chiara Spiniello^{1,2}
Crescenzo Tortora²
Giuseppe D'Agò³
Nicola R. Napolitano^{5,2}
and the INSPIRE Team

¹ Sub-Department of Astrophysics,
Department of Physics, University of
Oxford, UK

² INAF – Astronomical Observatory of
Capodimonte, Naples, Italy

³ Institute of Astrophysics, Pontificia
Universidad Católica de Chile, Santiago,
Chile

⁵ School for Physics and Astronomy, Sun
Yat-sen University, Guangzhou, China

Relics are the ancient fossils of the early Universe. They are ultra-compact and massive galaxies that formed only a few (1–2) billion years after the Big Bang, in a short and intense burst of star formation, and then evolved passively and undisturbed until the present day, completely missing the accretion phase predicted for the assembly of local giant early-type galaxies. As such, they represent a unique opportunity to put precise constraints on the first phase of structure formation in the Universe. Since the number of relics predicted at each redshift depends heavily on the mechanisms responsible for the accretion and growth of massive galaxies, obtaining number counts at $0 < z < 0.5$ is a very powerful way to validate and disentangle different possible physical scenarios driving their formation and size-evolution. INvestigating Stellar Population In RELics (INSPIRE) is an ongoing project based on an approved ESO Large Programme, targeting 52 relic candidates with the X-shooter spectrograph at ESO's Very Large Telescope with the aim of building the first statistically large catalogue of relics at $0.1 < z < 0.5$.

Relic galaxies: fossils of the ancient Universe

Massive early-type galaxies (ETGs) play a crucial role in the context of cosmic structure formation and mass assembly. Firstly, they contain the oldest stars at any epoch of the Universe's history, thus

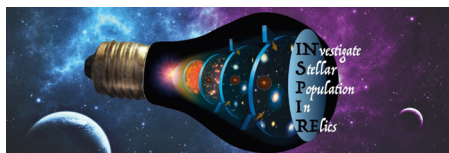

retaining the memory of the star formation activity that occurred in the earlier phases of galaxy formation. Secondly, they account for more than half of the total stellar mass in the current Universe and are responsible for most of its chemical enrichment. Understanding the history of the assembly of the most massive galaxies throughout cosmic time is therefore crucial to constraining models of galaxy formation and evolution.

The first generation of massive ETGs is already in place at $z \sim 3$, i.e., only two billion years after the Big Bang. However, at this redshift, most of the massive red objects are found to be 3–5 times smaller in size than their counterparts in the local Universe, and thus they are 30–100 times denser (van Dokkum et al., 2008). To reconcile these observations, a two-phase formation scenario (Oser et al., 2010) has been proposed to explain the mass assembly and evolution across cosmic time of very massive galaxies (Figure 1).

Initially, a series of intense, fast, dissipative processes forms their central “bulk” mass (at $z > 2$) generating, after star formation quenches, a massive, passive and very

compact galaxy with a size a factor of ~ 4 smaller than local massive galaxies (the so-called “red nuggets”). Then a second, prolonged phase, dominated by mergers and gas inflows, is responsible for the structural evolution and size growth from $z \sim 1$ to today. The ultra-compact objects formed at high redshift likely end up forming the cores of giant local galaxies, whilst subsequently accreted or newly formed stars remain preferentially in the external regions. Unfortunately, this “accreted” material overlaps, along the line of sight, with the spatial and orbital distributions of the *in-situ* pristine light that encodes the information about high- z baryonic processes, irreversibly limiting our resolving power and hampering our ability to study the early phases of galaxy formation. Luckily, since merging is a stochastic phenomenon, a small fraction of red nuggets survives intact until the present day, without experiencing any merger or interaction and thus remaining as massive and ultra-compact as they formed: relic galaxies (Trujillo et al., 2009). Since a detailed study of the stellar populations of high- z red nuggets would require prohibitive integration times with the currently available facilities, relics are the only systems that allow us to study the physical processes that shaped the mass assembly of massive galaxies in the high- z Universe in the amount of detail currently reachable only for the nearby Universe.

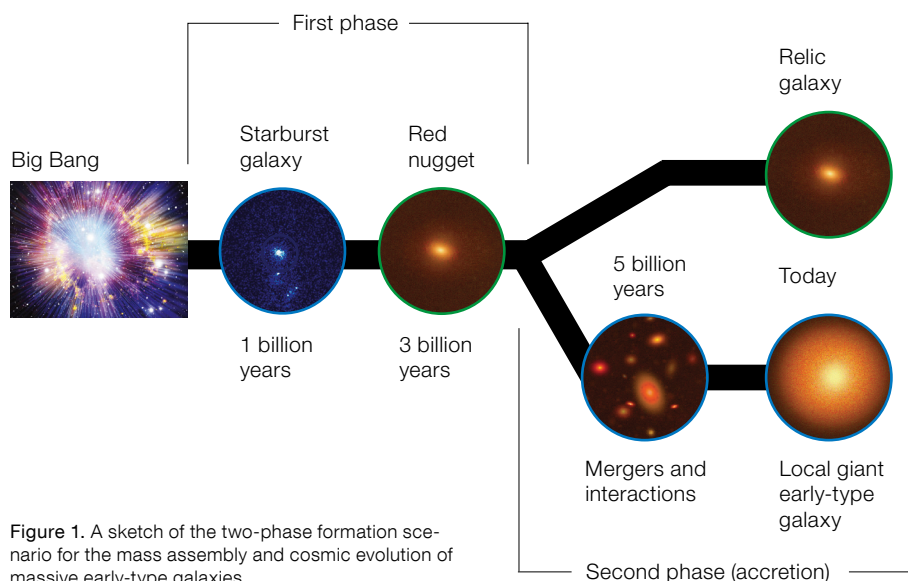
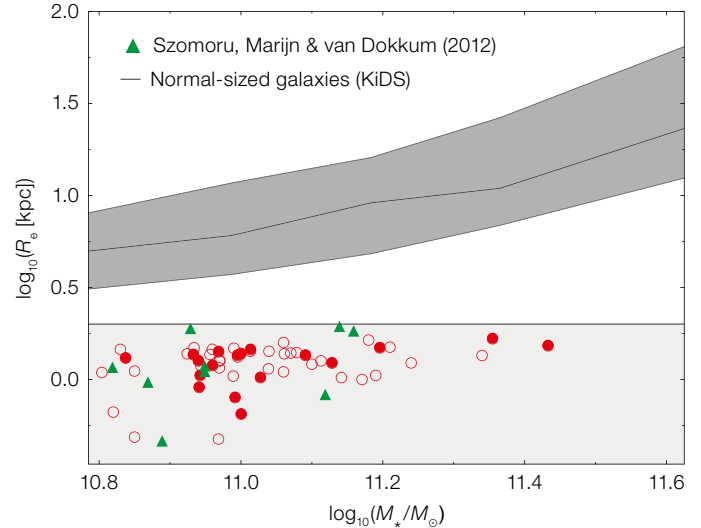
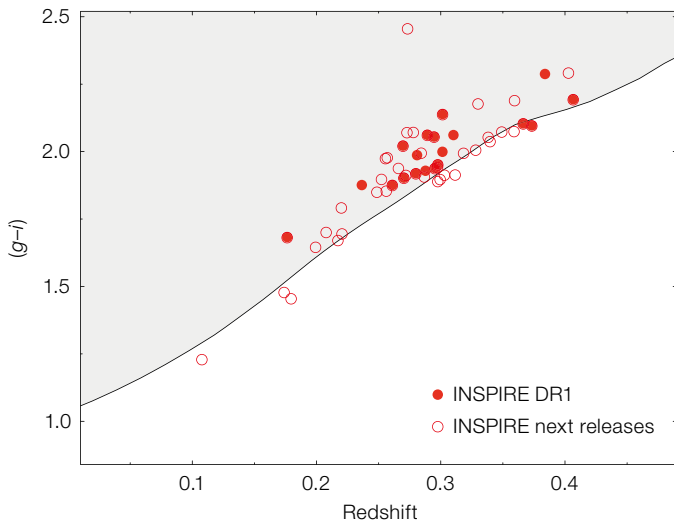

Figure 1. A sketch of the two-phase formation scenario for the mass assembly and cosmic evolution of massive early-type galaxies.



But how many relics exist in the Universe at each redshift, and how many survive until the present day? How can they passively evolve through cosmic time without experiencing any interaction? What can we learn about the merging history and the evolution of the most massive ETGs? Is there a physical scenario, predicted by hydrodynamical cosmological simulations, that is able to explain all the current observational results at all redshifts? These and other questions remain to be answered and constitute the main topics of the INvestigate Stellar Populations In Relics (INSPIRE) Project.

The INSPIRE ESO Large Programme: observational strategy and current status

The INSPIRE¹ ESO Large Programme (ID: 1104.B-0370, PI: Chiara Spiniello) was approved two years ago to spectroscopically follow up with the X-shooter spectrograph 52 ultra-compact, red, massive galaxies with redshifts $0.1 < z < 0.5$. They are the final products of a dedicated project within the Kilo Degree Survey² (KiDS) collaboration, one of the three ESO VST Imaging Public Surveys³. This project started in 2015 with the goal of building the largest catalogue of photometrically selected passive (non-star-forming) galaxies with incredibly small sizes but stellar masses comparable to those of massive local ETGs (Tortora et al., 2016), and with secure structural parameters inferred from *gri*-band KiDS images (Roy et al., 2018). Subsequently,

spectroscopic follow-ups at many different ESO and non-ESO telescopes have been obtained to validate these objects, inferring their redshifts and masses and thus confirming them as ultra-compact massive galaxies (Tortora et al., 2018; Scognamiglio et al., 2020). These objects are the perfect relic candidates, as they all have large stellar masses ($M_* > 6 \times 10^{10} M_\odot$), small sizes ($R_e < 2$ kpc) and very red colours indicative of an evolved, old stellar population (see Figure 2).

The INSPIRE observing strategy has been optimised to capitalise on relatively sub-standard observing conditions (seeing up to 1.2 arcseconds, clear nights, grey lunar phase with a lunar illumination fraction up to 0.5), allowing the objects to be easily scheduled into the observing queue. Moreover, the selected targets span a very wide range in right ascension and declination, with an optimum observing time spread over the full year. We also note that we have many systems with declination below -30 degrees, perfect as “fillers” on nights with strong wind coming from the north. The integration time on target, which varies from target to target according to their *r*-band luminosity and surface brightness, has been set to reach a signal-to-noise ratio sufficient to infer the age, metallicity and α -abundance of the stellar populations.

At the time of writing, data on 38 out of 52 galaxies have been collected, and 36 objects have already been completely observed. In Spiniello et al. (2021a, here-

Figure 2. Left: Observer-frame $(g-r)$ colour versus redshift for the 52 INSPIRE objects (red circles). Filled symbols indicate the 19 galaxies included in DR1, while empty ones are those that will be released in the future. The grey region shows the predicted values for single stellar population models with ages of 8 Gyr (black) or older. Right: Stellar mass-size relation of relic candidates (same colour code as above) compared to the relation for normal-sized passive galaxies from the KiDS survey, shown as a dark-grey shaded region and to high-redshift red nuggets from the collection of Szomoru, Marijn & van Dokkum (2012).

after S21a), we presented a pilot programme demonstrating the feasibility of the project and showing the kinematical and stellar population analysis for three objects representative of the whole sample. Results for the first 19 galaxies, completely observed before the end of 2020, are presented in Spiniello et al. (2021b, hereafter S21b), and released as part of the first INSPIRE data release (DR1). DR1 was made publicly available through the ESO Archive Science Portal⁴ in March 2021. It comprises one-dimensional (1D) spectra in the UVB and VIS arms of X-shooter for 19 ultra-compact massive galaxies that were observed between 22 October 2019 and 31 December 2020 and were classified as relics or not in S21b. Near-infrared spectra, which are not necessary for the confirmation of the relic nature of the systems but which are crucial to correctly inferring the stellar initial mass function (IMF), will be analysed and released in a separate forthcoming data release, accompanied by a dedicated scientific publication (see next section for more details).

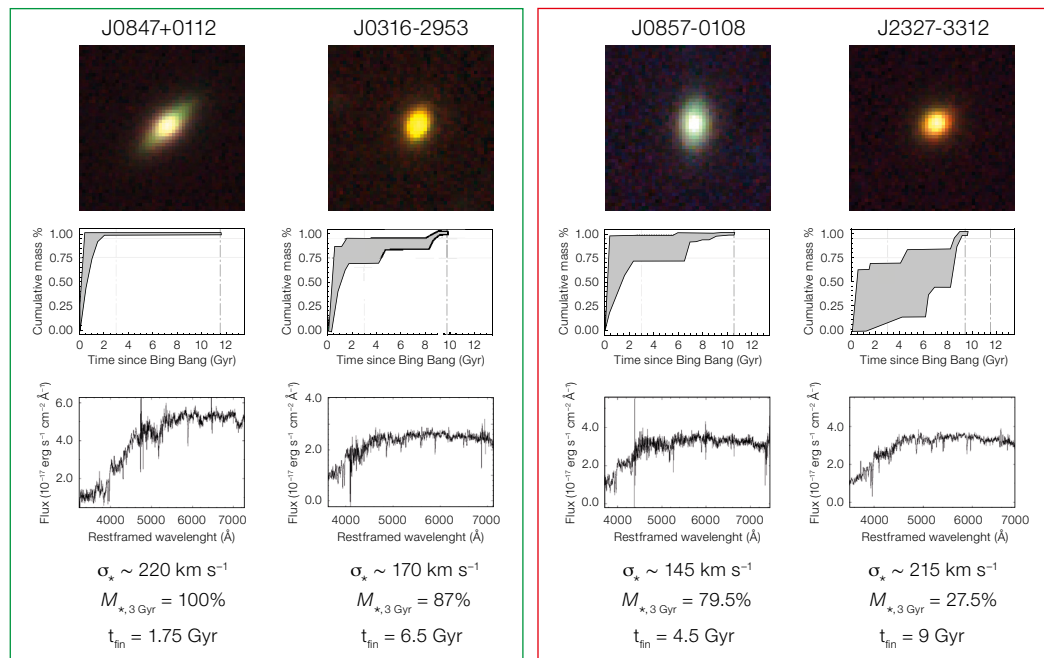

Figure 3. Four objects from INSPIRE DR1, each with a different “degree of relicness”. In the green box, we show the most extreme and the least extreme relics, whilst in the red box we show the non-relics with the least and most extended star formation history. For each galaxy, the top panel shows a 10×10 arcsecond colour-combined (*gri*) KIDS image, the middle panel shows the fraction of stellar mass assembled in cosmic time since the Big Bang, varying the $[\text{Mg}/\text{Fe}]$ by ± 0.1 (grey area), and the bottom panel shows a zoom-in to region of the spectrum used to compute the velocity dispersion, and the stellar age and metallicity. The values for the stellar velocity dispersion, the mass assembled at the end of the first formation phase ($z \sim 2$, 3 billion years after the Big Bang) and the time of final assembly (when more than 95% of the stellar mass was in place) are also provided.

INSPIRE DR1: kinematics, stellar population analysis and relic confirmation for the first 19 systems

Here we focus on three main scientific results, obtained from the 19 systems with complete observations until the end of 2020, presented in S21b (also including the three pilot galaxies presented in S21a): i) the integrated velocity dispersion values inferred from the 1D spectra encapsulating 50% of the light (30% in S21a) of the galaxies and those inferred from optimally extracted 1D spectra; ii) a precise estimate of the stellar age, metallicity and $[\alpha/\text{Fe}]$ abundance of the stellar populations, from line indices and full spectral fitting; and iii) star formation histories and “relic confirmation” based on the fraction of stellar mass assembled during the first phase of the two-phase formation scenario and on the cosmic time of “final assembly”.

The velocity dispersion values are always relatively high ($\sigma_* > 150 \text{ km s}^{-1}$), confirming the massive nature of the systems. Although with limited statistics, we observe that the galaxies confirmed as relics have a systematically larger velocity dispersion compared to non-relics, for the same stellar mass. Since σ_* is approximately proportional to the dynamical mass of the galaxy within the half-light radius, the

overall larger σ_* in relics would indicate a higher dynamical mass compared to non-relic galaxies of similar stellar mass. This can have two possible physical explanations. On the one hand, relics could have a larger number of stars with very low masses — i.e., a dwarf rich IMF — which contribute very little to the light but substantially to the dynamical mass. On the other hand, relics could have a larger fraction of dark matter in the central regions or, possibly, dark matter halos with a higher central mass density.

Spectroscopic ages are very old for 13 out of 19 galaxies, in agreement with the photometric ones, and metallicities are almost always (18 out of 19) super-solar, confirming the mass-metallicity relation. The $[\text{Mg}/\text{Fe}]$ ratio, that sets the clock of the star formation (i.e., larger values indicate a faster star formation episode) is also larger than solar for the great majority of the galaxies, as expected.

We find that 10 objects have formed more than 75% of their stellar mass within 3 Gyr of the Big Bang, when the first phase is believed to end, and therefore we classify them as relics. Amongst these, we identify 4 galaxies which had already fully assembled by that time. They are therefore “extreme relics” of the ancient Universe.

The INSPIRE DR1 catalogue of 10 relics known to date augments by a factor of 3.3 the total number of confirmed relics, also enlarging the redshift window outside the local Universe (up to $z \sim 0.4$). It is therefore the largest publicly available collection at the moment. Thanks to the larger number of systems, we can confirm the existence of a “degree of relicness” (Figure 3), already hinted at in the literature, quantifying how fast the star formation histories are. This degree of relicness might correlate with the structural parameters of the galaxies (for example, size or ellipticity), dynamical properties (i.e., the extreme relics are the systems with the largest velocity dispersions) and/or with the environments in which they live. We will investigate this matter further once the full INSPIRE sample has been analysed, as described in the next section.

Future INSPIRE data releases and final scientific goals

At least two further data releases will be issued for INSPIRE. In the second data release, foreseen in roughly six months, we will add the near-infrared (NIR) spectra of the 19 systems released in DR1. Extending the wavelength range towards the red, we will be able to constrain, at

least for the stacked spectrum of all the 10 relics, the slope of the IMF at the low-mass end. The stellar IMF is the distribution of stellar masses that form in one star-formation event in a given volume of space. Hence, all the observable properties of stellar systems are heavily influenced by their IMFs, since the mass of a star determines its subsequent evolutionary path. Furthermore, almost every observable property of a galaxy depends on its mass-to-light ratio (M/L) and the low-mass end of the stellar IMF is crucial in determining that. In fact low-mass stars account for more than half of the mass budget but they contribute very little to the integrated luminosity of a galaxy with an old stellar population. This makes the characterisation of the low-mass IMF slope from integrated light a very difficult task but also a crucial ingredient for partitioning galaxy mass into stellar and dark matter, and for understanding how they interact in the internal region of galaxies. This, in turn, allows one to predict the luminosity evolution of passively evolving stellar systems and thus to correctly interpret the cosmic evolution of the most massive galaxies in the Universe.

The third data release, which will be made available upon completion of all the spectroscopic observations, will comprise 1D spectra for all the 52 objects, of which half will likely be confirmed as relics, based on the current results (10 out of 19). With more objects at our disposal, we will further investigate possible correlations between the degree of relicness and other galaxy properties (size, mass, colours) and/or with the environments in which they sit.

The final INSPIRE catalogue of confirmed relics, all with precise structural, kinematic and stellar population parameters measured, multi-band wide-field optical and NIR photometry and high signal-to-noise spectroscopic data, will represent an important benchmark for cosmological simulations that should reproduce the number density and the morphological, dynamical and stellar characteristics of both relics and younger ultra-compact galaxies.

Since different models predict a different redshift evolution of the number density of relics, a statistically significant cata-

logue of relics at different redshifts is a *conditio-sine-qua-non* to disentangle possible physical scenarios driving the formation and size-evolution of galaxies. At the same time, the characterisation of the structural, dynamical, environmental, and stellar properties of the non-relics, ultra-compact systems that have just stopped forming stars, will provide a key test for models of galaxy formation. In fact, according to hydrodynamical simulations very compact and very massive galaxies should only form in gas-rich environments, and thus early on in time, and then undergo a series of mergers and interactions which should cause a growth in size. We will compare the INSPIRE galaxies (both relics and non-relics) with ultra-compact simulated galaxies from different hydrodynamical simulations to shed light on the formation scenario and mass assembly of these extremely compact, passive and massive objects, and to understand the conditions that allowed these objects to survive intact to the present day without undergoing any accretion event.

Likewise, we will compare the final INSPIRE sample with normal-sized ETGs at similar redshifts and with similar structural and photometric (magnitudes and colours) distribution, of comparable stellar masses and with optical spectra available. In particular, for the normal-sized ETGs we will derive mass-weighted ages and metallicities, and thus star formation histories, using the same code and under similar assumptions and setups to those used in S21b. This will allow us to assess whether relics are simply the ultra-compact tail of the distribution of red and dead ETGs or if they are special and very rare systems with a completely different evolutionary path.

Thanks to the high quality of the spectra, we will measure very precise ($< 5\%$ uncertainties) integrated velocity dispersion values (σ_*) for each system. This is one of the most fundamental tracers of the stellar populations and halo masses of galaxies, and hence can act as a valuable identifier of a consistent population over cosmic time. Measuring σ_* from spectroscopic data and performing dynamical models, we will infer dynamical masses. Then, estimating precise stellar masses via stellar population analysis, we will be

able to compute the ratio between stellar and dynamical mass (M_*/M_{dyn}) which is a valuable tracer of the likely mechanism by which galaxies grow. In fact, under merger-driven growth, the M_*/M_{dyn} ratio, measured within the effective radius, should decrease with time; this decrease would be stronger in the case of minor mergers. Thus, under the hypothesis that relics experienced very few mergers, or none at all, they should all show a very high M_*/M_{dyn} , compared to normal-sized galaxies of similar stellar masses, and thus a smaller amount of dark matter.

Acknowledgements

The authors wish to thank the ESO Archive Science Group, led by Magda Arnaboldi, for the precious help in making the INSPIRE DR1 publicly available as Phase 3 Collection. CS is supported by a Hintze Fellowship at the Hintze Centre for Astrophysical Surveys at the University of Oxford, which is funded through generous support from the Hintze Family Charitable Foundation. NRN acknowledges financial support from the ‘‘One hundred top talent program of Sun Yat-sen University’’ grant N. 71000-18841229. GD acknowledges support from CONICYT project Basal AFB-170002.

References

- Oser, L. et al. 2010, ApJ, 725, 2312
- Roy, N. et al. 2018, MNRAS, 480, 1057
- Scognamiglio, D. et al. 2020, ApJ, 893, 4
- Spiniello, C. et al. 2021a, A&A, 646, A28
- Spiniello, C. et al. 2021b, arXiv:2103.12086
- Szomoru, D., Marijn, F. & van Dokkum, P. G. 2012, ApJ, 749, 121
- Tortora, C. et al. 2016, MNRAS, 457, 2845
- Tortora, C. et al. 2018, MNRAS, 481, 4728
- Trujillo, I. et al. 2009, ApJL, 692, L118
- van Dokkum, P. G. et al. 2008, ApJL, 677, L5

Links

- ¹ The INSPIRE project webpage: <https://sites.google.com/inaf.it/chiara-spiniello/inspire/>
- ² The Kilo Degree Survey: <http://kids.strw.leidenuniv.nl>
- ³ The ESO VST Public Surveys: <https://www.eso.org/sci/observing/PublicSurveys/sciencePublicSurveys.html#VST>
- ⁴ The INSPIRE DR1 ESO Phase 3 collection on the Science Archive Portal: http://archive.eso.org/scienceportal/home?data_collection=INSPIRE

A spectacular lunar halo — known as a 22° halo — formed in the sky above ESO's La Silla Observatory. The optical phenomenon is a result of moonlight interacting with ice crystals suspended in the atmosphere, forming a ring with an apparent radius of approximately 22° around the moon. It is also known as the "moon ring" or "winter halo".



Maintaining Scientific Discourse During a Global Pandemic: ESO's First e-Conference #H02020

Richard I. Anderson^{1,2,3}
Sherry H. Suyu^{4,5,6}
Antoine Mérand¹

¹ ESO

² ORIGINS cluster, University Observatory Munich, Germany

³ Laboratory of Astrophysics, Institute of Physics, EPFL, Lausanne, Switzerland

⁴ Max Planck Institute for Astrophysics, Garching, Germany

⁵ Technical University of Munich, Garching, Germany

⁶ Academia Sinica Institute of Astronomy and Astrophysics, Taipei, Taiwan

From 22 to 26 June 2020, ESO hosted its first live e-conference, #H02020, from within its Headquarters in Garching, Germany. Every day, between 200 and 320 participants around the globe tuned in to discuss the nature and implications of the discord between precise determinations of the Universe's expansion rate, H_0 . Originally planned as an in-person meeting, we moved to the virtual domain to maintain strong scientific discourse despite the COVID-19 pandemic. Here we describe our conference setup, feedback gathered from participants before and after the meeting, and lessons learned from this unexpected exercise. As e-conferences will become increasingly common in the future, we provide our perspective on how they can make scientific exchanges more effective and inclusive, and also climate friendly.

Before 18 March 2020: in-person conference at ESO Headquarters, Garching

Our preparations for an in-person conference involving approximately 100 participants began in summer 2019, shortly after the Kavli Institute for Theoretical Physics workshop on Tensions between the Early and the Late Universe (Verde, Treu & Riess, 2019). Together with the Scientific Organising Committee (SOC), composed of Chuck Bennett, Annalisa Calamida, Matthew Colless, Frédéric Courbin, Claudia de Rham, Wolfgang Gieren, Chow-Choong Ngeow, Hiranya Peiris, Mickael Rigault, Dan Scolnic and Licia Verde, we selected invited speakers who would cover a wide range of topics from basic

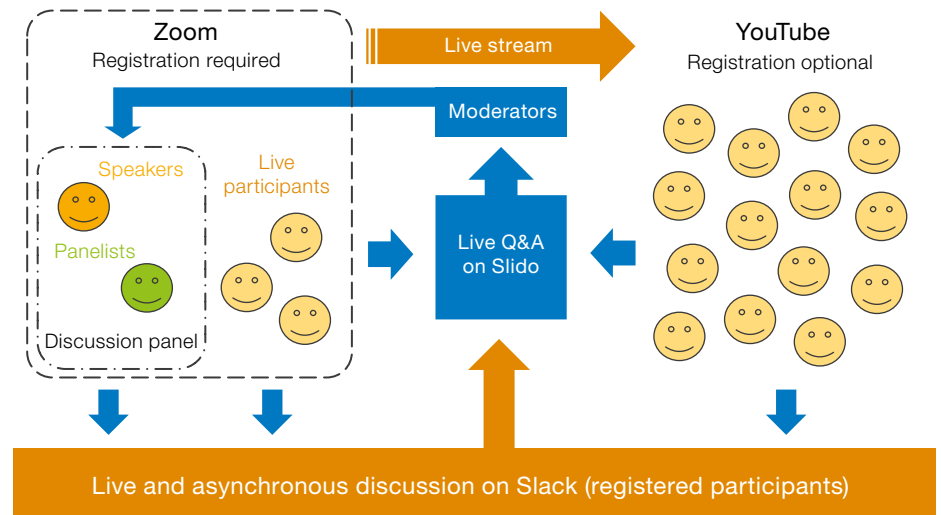

Figure 1. The #H02020 online meeting setup.

astrometry to theoretical cosmology. The conference was planned to run from Monday to Friday, featuring 20 invited talks, 2 introductory lectures, 34 contributed talks, 8 short 10-minute discussion sessions, four 10-minute poster flash talk sessions in addition to physical posters, and a 1.5-hour discussion panel at the end. A public lecture by Adam Riess at the Technical University of Munich's downtown campus was also planned.

Registration for the workshop opened in late January 2020 with abstracts due by 1 April. However, as cases of COVID-19 started skyrocketing in February and March, it became clear that an in-person meeting in June was unrealistic. Faced with the question of whether to postpone or cancel the meeting, on 26 March we decided on a third option: to convert the in-person meeting to a live global e-conference within the course of 12 weeks.

We had no blueprint to follow and no pre-arranged technical solutions for implementing ESO's first global live e-conference, leading to a somewhat tricky situation that was rendered even less straightforward by the fact that nearly all ESO staff were working remotely for the first time. Nonetheless, we felt strongly that maintaining strong international scientific discourse was worth the challenge — especially since many other meetings were being cancelled or postponed indefinitely — and we decided to go ahead with this meeting despite the short planning timescale.

Participant surveys before & after the meeting

Recognising the experimental nature of our e-meeting, we conducted participant surveys before and after the meeting to assess how well it met participant needs and expectations, and to measure whether it fulfilled our own goals. Before the conference we collected responses from 89 individuals, and 79 afterwards. Since anonymous submissions were allowed, only 46 before & after responses could be uniquely matched. The following account is based on this survey information.

Goals of the online meeting

In adapting the conference for the virtual domain, we pursued the following main goals:

1. To advance the specific research field by enabling continued international scientific exchange.
2. To create a schedule compatible with most regions of the world.
3. To foster informal discussions that go beyond the scope of the invited presentations.
4. To strike a balance between giving the wider community a strong voice and covering a broad range of topics via invited presentations.
5. To explore and leverage benefits inherent to online meetings, such

participants to get in touch with each other directly via one-to-one chat or video calls. Over the course of the conference week, participants exchanged more than 1500 messages, including organisational messages, scientific discussions, answers to questions, diagrams and other documents, such as presenter slides. However, becoming familiar with several new communication tools at once (Zoom, Slido, Slack) represented an initial hurdle for some participants. Once accustomed, though, participants reacted very positively to Slack as a coherent communication platform for the meeting.

Participation and representation

We sought fair community representation among SOC members, who helped select a diverse set of invited speakers across the spectrum of career stages, locations, gender, and subject matter. Registration was open until the 300 person limit of the Zoom license was exhausted. The list of participant host countries used to create Figure 3 was determined from participants' IP addresses during registration. The only information collected concerning the identity of participants was name, position, and affiliation. Gender statistics shown in Figure 4 are derived from manually (and possibly incorrectly) assigned (binary) gender based on first names.

Representation of women amongst the invited speakers and the SOC was significantly higher than amongst all registered participants. Gender representation amongst panel members mirrored the registration demographics. Two participants who had requested panel slots were not assigned because they either misunderstood the panel setup or because they had not yet completed graduate studies. Six of the 20 invited speakers were early-career researchers. The all-male 'other' category in Figure 4 comprises six retirees, one teacher, one journalist, one freelance researcher, and three other types that did not fit any other category.

We note the sharp decrease in female representation between the categories of students and postdocs. It is a well-known fact that retaining qualified women is a major issue in STEM fields, and the

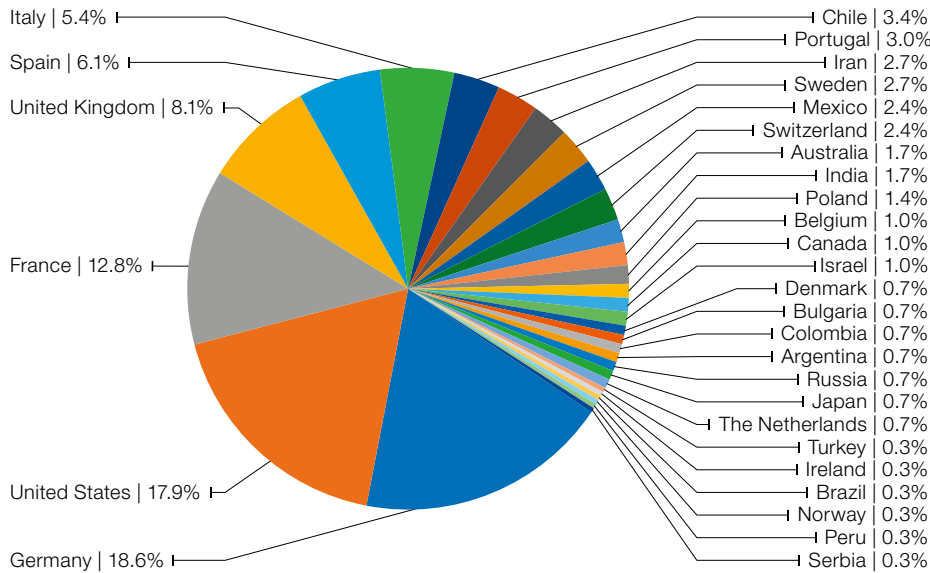

Figure 3. Registration locations by IP address.

observed trend suggests that women are less likely than men to continue beyond their doctorate degrees towards a career in astronomy. However, we do not have sufficient information to assess this drop-off in detail, or to cross-reference it with other potentially relevant factors, such as postdoc-seniority or childcare responsibilities, which has disproportionately impacted women during the COVID-19 pandemic.

Representation of people of colour amongst speakers and panelists was low, particularly in the case of non-Asian people of colour. This was especially evident given the timing of the meeting, which coincided with #BlackinSTEM week. There are many and complex reasons for the underrepresentation of people of colour in STEM, and they may differ significantly across different regions of the world. However, online conferences in particular should strive to do better since barriers to participation (funding, travel, etc.) are lower than for in-person conferences. We note that we could not identify any participants from the African continent based on either IP address, e-mail address, host institute name, or YouTube analytics data, although we did have participants from several underprivileged countries. We had listed our conference on the Canadian Astronomy Data Centre

website⁵ and advertised it through ESO's mailing list, newsletter and website, and several astronomy-related mailing lists, also advertising it on Twitter. We are concerned that our announcement practices could have excluded people from certain regions, and we have identified that internet censorship would have prevented potential participants from China or Iran from seeing our Twitter posts or YouTube live streams. Professional organisations such as the International Astronomical Union could play an important role in providing guidance on the best ways to increase diversity in virtual conferences.

Up to 120 participants (registered or not) joined via the YouTube livestream every day. YouTube channel analytics provide information concerning audience age, location, and gender, as shown in Figure 5. The analytics available are far from complete since they are likely based on inhomogeneous samples including registered and unregistered YouTube users, depending on category. For example, the total number of views by location adds up to only 46%; location information is missing for the majority of viewers. Nonetheless, we see that YouTube was favoured by a younger audience, possibly down to different approaches to using the internet and/or different career stages.

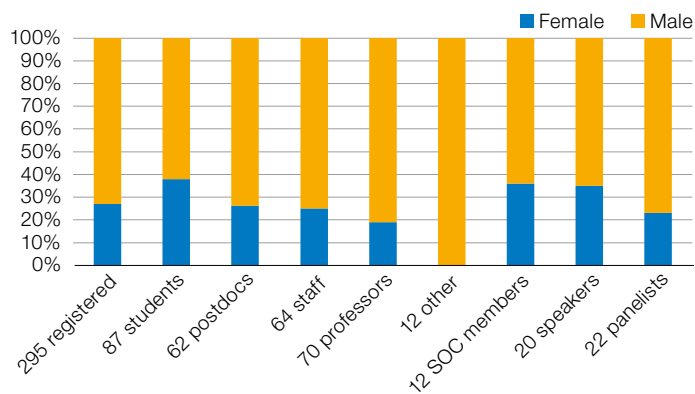

Figure 4. Career and gender demographics. Gender was assigned according to first names provided. One postdoc's name could not be assigned a gender.

Goal 5: reducing access barriers to increase diversity, equity, and inclusion

We deliberately collected no registration fees in order to allow any interested parties to participate. For comparison, the in-person registration fee would have been 180 euros (80 euros for students). After converting our conference to an online format, we set up a new registration form. The registration served several purposes, including limiting access to the Zoom call and Slack workspace, collecting consent to being recorded/live streamed, and ensuring that participants pledged to abide by the ESO code of conduct. However, the entire conference was publicly accessible even without registration via the YouTube live stream and questions on Slido. All software tools used (Zoom, Slido, Slack) were free of charge to participants and compatible with a maximum number of operating systems with no installations required apart from a WebRTC capable browser (for example, Firefox, Chrome, Opera).

Most feedback mentioned that removing the need to travel was a key advantage of the virtual format, irrespective of the COVID-19 pandemic. Specific reasons given included childcare, teaching and other work-related duties, care of pets, visa-related issues, time saved by not travelling, avoiding exhaustion (for example, jet lag), health concerns, dietary considerations, and more. An Australian

participant emphasised that these benefits far outweighed the inconvenience of late-night sessions.

Anonymous questions were perceived by many as an important advantage over classical Q&A. With no need to fear embarrassment, many basic questions were submitted and voted for, in particular during more theory-heavy talks. Irrelevant questions — a concern for those opposed to anonymous questions — were not an issue because they were very few and did not get upvoted. The 160-character limit of Slido was considered a challenge by some participants, although lengthier questions could also be relayed to the Slack workspace.

A notable benefit of YouTube was the ability to enable closed captioning (English subtitles). The average view duration was 38 minutes 22 seconds with subtitles enabled, compared to 20 minutes 59 seconds without subtitles; the 7.6% of views with subtitles enabled accounted for 13% of the time watched on YouTube. This underlines the need to assist participants in engaging with the materials presented, especially in the case of persons with impaired hearing or non-native English speakers. George Jacoby (NSF's NOIRLab) further pointed out that participation conditions were more equal here than in usual meetings because everyone sat in the front row with an unobstructed view and adjustable speaker volume.

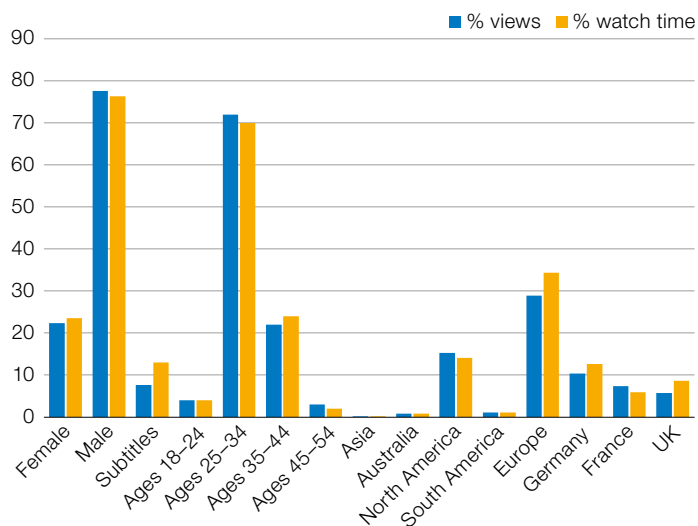

Figure 5. YouTube channel analytics.

A frequently mentioned drawback of the virtual format is that it is less conducive to informal discussions than in-person meetings. However, survey feedback also revealed interesting potential benefits to those discussions that did take place on Slack. First, discussions on Slack were transparent to all participants instead of only a small group of people (for example, coffee-break clusters), helping non-specialists gain deeper insights “behind the scenes”. Second, discussions could later be synthesised from the recorded chat text. Third, one participant mentioned they felt more at ease entering into an online discussion with strangers than they would have done in person.

Overcoming shortcomings

The possibility for young scientists to present themselves and their work is crucial to fostering their career development and to providing a forum for “hot-off-the-press” results that may revolutionise a field in the future. Unfortunately, in this instance we were not able to arrange for contributed talks by, for example, students and early career scientists. However, feedback offered two very attractive options for including early-career contributions despite a tight live schedule: a) pre-recorded contributed talks available for asynchronous viewing ahead of invited talks and discussion sessions; and b) online poster sessions on Slack. To pre-

vent exclusion by internet censorship, all essential content should be rendered accessible on platforms freely accessible worldwide.

While e-conferences are not subject to travel-related access barriers, several other barriers may apply to the same groups who would have difficulty attending in-person meetings. These include internet censorship, lack of broadband internet access, and the need for access to suitable personal devices (for example, 1 laptop per person), among other aspects that should be considered even before planning virtual meetings. One way of addressing such issues could be to create regional viewing hubs once health measures allow it, as outlined by Reshef et al. (2020).

Perhaps the most common negative feedback from participants was that they had wished for more opportunities for discussion. The key to improving this aspect of e-conferencing seems to be to motivate participants to commit to offline discussions. Obstacles to this include a lack of engagement (intentional or circumstantial) and the complexity of orienting oneself in a Slack workspace. During #H02020, we witnessed participants become increasingly engaged as they learned how to use this tool. In particular the ability of direct video calls amongst Slack workspace members seems to have been underused. Instructions for how to use Slack should therefore be part of the onboarding information, and using the same tools in all conference-related communications would lower the need for participants to familiarise themselves with new tools each time. Additionally, asking participants to specify keywords upon registration could help to assign discussion groups, connect participants according to interests, and foster networking.

Final thoughts and recommendations

The fact that e-conferencing is much more climate-friendly than classical conferences is widely known in the community and the carbon savings of e-conferences have been described in detail by, for example, Jahnke et al. (2020). Nonetheless, it took a worldwide health emergency to accel-

erate the adoption of e-conferencing. Now that the initial step has been taken, e-conferences are becoming commonplace and will likely become an integral part of scientific discourse, not least because they are cheaper and more convenient for participants. Targeting our goal number 6 above, we now close with some final thoughts and recommendations.

First and foremost, feedback clearly shows that participant satisfaction with this conference (on both the scientific and technical level) was high, and it is worth noting that no-one stated that the conference had been worse than expected. Instead, many were positively surprised, and a majority stated that this meeting increased the likelihood of their organising an e-conference themselves. The Q&A sessions on Slido in particular were a highlight for most, with 58% (46/79) saying the Q&A was very effective, 25% somewhat effective, and only 1/79 indicating that it was somewhat ineffective. Several people even stated they hoped for Slido-style Q&A to be incorporated in future face-to-face meetings.

Of course, valid criticisms exist about e-conferences and their limitations, notably concerning the lack of direct human interaction. Participants particularly noted the following issues, in arbitrary order: a) the lack of body language; b) difficulty meeting new people; c) missing off-the-record discussions; d) the missing cultural elements of international travel that are crucial to fostering understanding across cultures, languages, etc.; e) missing networking opportunities; and f) missing opportunities for senior and junior researchers to meet. Some of these drawbacks that may seem unsurmountable now may be addressed by smart e-conference design or may evolve as social norms evolve, for example regarding (online) networking etiquette. However, the human aspect of conferences is vital to scientific exchange and must not be neglected.

E-conferences may also harbour long-term negative side effects. For example, privacy concerns remain underdiscussed, despite recorded live streams' drastically changing the dynamic and persistence of participant contributions. Additionally, e-meetings tend to shift the costs and

"Are you now more likely to host e-conference?"

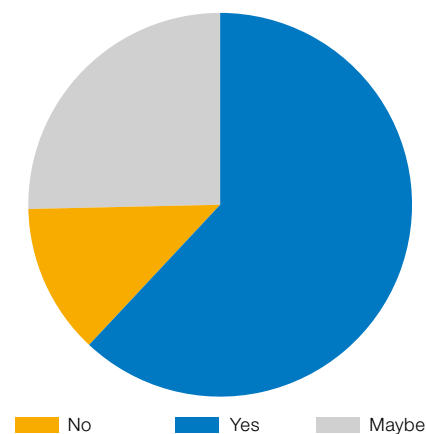

"How effective did you find Q&A on Slido?"

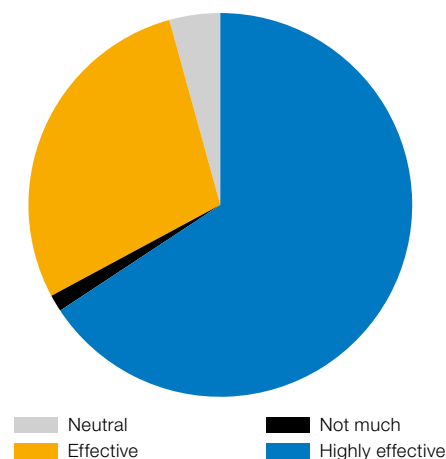

effort of attending conferences from the professional to the private domain, for example regarding food & drink, physical (office) space, computing resources, etc.

At the same time, classical in-person conferences also have significant shortcomings that are easily forgotten or overlooked, perhaps because the community is used to them. Classical conferences are biased both implicitly (for example, stereotypes, personalities) and explicitly (for example, ability to travel), resulting in unintended exclusionary practices or situations. As a result, in-person meetings prioritise specific types of human interactions over other interactions that could lead to other benefits, such as transparent discussions, and foster equity, diversity and inclusion.

Social media are the native communication platforms for e-conferences. Organ-

isers should include social media in their announcement strategies and seek advice from press or outreach offices to make adequate use of social media, bearing in mind the possibility of censorship.

Another issue to solve is that of the complexity of conference software. At the time, our review of the available software revealed no single solution that would have incorporated all the functionality desired for our meeting, so we adopted a hybrid approach involving Zoom/YouTube, Slack, and Slido. Although corporate solutions do exist, they can be costly and were thus not applicable for an event with zero registration fees. A detailed comparison between different software solutions is beyond the scope of this article, but should certainly be conducted. The documentation and research gathered by the EuroPython conference series⁶ offer substantial insights concerning the technical aspects of online conferencing.

It is not clear that this conference could have taken place perhaps just 5 years ago. Projecting this rapid progress into the future, new tools and solutions will become available that may lead to even more options to choose from, and thus more complexity for conference attendees. To facilitate virtual-domain scientific cooperation in the future, it may be useful to define or develop a platform or set of tools (perhaps an open source version of Slack, such as CERN's Mattermost⁷, hosted by an institute) that the community can adopt over a time span and that renders the learning curve worthwhile. Whilst the creative and competitive development of new tools certainly leads to innovation, standardisation would make it worthwhile for scientists to invest time in becoming familiar with such channels.

We believe that e-conferencing can replace a majority of in-person conferences in the future, and we see many good reasons for this development. These notably include environmental benefits, time savings, and opportunities for increasing diversity, equity and inclusion, as well as the ability to create new conference formats that allow improved global scientific discourse. Yet the human element of scientific exchange must also be satisfied for science to progress. Hence, in-person meetings will remain a

key aspect of scientific exchange. Combining the two options would benefit from the best of both worlds, and we believe this could be achieved by increasing coordination amongst conference organising committees. For example, one could imagine a few very large international meetings per year that primarily focus on networking and personal interactions, once health issues allow. These in-person networking events could be complemented by frequent e-conferences focused on presenting scientific results, with the possibility for networking events centered around regional screenings. At the same time, free online seminar series, such as the Golden Webinar series⁸ or the ESO Cosmic Duologues⁹, are offering new opportunities for scientific exchange.

The scientific community has entered a new era of possibilities for scientific exchange. We argue that there could be immense benefits on the horizon, and reducing our carbon footprint is certainly one of them. However, the drawbacks, challenges, and potential dangers of e-conferencing should not simply be ignored. A larger conversation should therefore consider how e-conferencing will become a safe, inclusive, and carbon-friendly addition to the landscape of international scientific discourse.

Acknowledgements

We thank all the participants of #H02020, and especially the speakers, panelists, SOC members, and the many participants who provided feedback.

We thank Stella Chasiotis-Klingner and Nelma Alas Da Cunha Dias Da Silva for their administrative assistance, ESO safety and logistics personnel for helping us set up the H02020 control centre in a safe environment during a health pandemic, and Marius Chelu for setting up the room infrastructure.

Many colleagues showed enthusiasm for an e-conference and contributed ideas that made this meeting a success. These include (in no particular order): Jason Spyromilio, Michael Hilker, Giacomo Beccari, Remco van der Burg, Marianne Heida, Dominika Wylezalek, Anna Miotello, Carlo Manara, Sara Mancino, ESO Director for Science Rob Ivison, ESO Director General Xavier Barcons, and many others. We also thank Behnam Javanmardi for covering the conference on reddit¹⁰. We thank the Max Planck Institute for Astrophysics (MPA) for providing access to their Zoom license, and Andreas Weiss at MPA for IT support. We thank Slack and Slido for offering free trial versions of their platforms, which made this conference setup possible, and YouTube for offering the free live streaming capability as well as the ability to revisit videos later. We thank

the Technical University of Munich for providing the venue for the public talk that was originally planned for the in-person conference, and Karin Lichtnecker and Gudrun Obst for the arrangements. R. I. Anderson acknowledges support through an ESO Fellowship, the ORIGINS excellence cluster visitor programme, and from the Swiss National Science Foundation through an Eccellenza Professorial Fellowship (award No. 194638). S. H. Suyu thanks the Max Planck Society for support through the Max Planck Research Group, and the European Research Council (ERC) for support under the European Union's Horizon 2020 research and innovation program (LENSNOVA: grant agreement No 771776).

References

- Jahnke, K. et al. 2020, *Nature Astronomy*, 4, 812
 Reshef, O. et al. 2020, *Nature Reviews Materials*, 5, 253
 Verde, L., Treu, T. & Riess, A. G. 2019, *Nature Astronomy*, 3, 891

Links

- 1 Video explaining the e-conference setup: <https://www.youtube.com/watch?v=j2HkdQpc7fc&t=1s>
- 2 Webpage with details of the H02020 conference: <https://www.eso.org/sci/meetings/2020/H0.html>
- 3 Conference YouTube page: https://www.youtube.com/channel/UCs0UoIX-xdD_hU8RI-qSbLA
- 4 Slack workspace: <https://h02020.slack.com>
- 5 Canadian Astronomy Data Centre website: <https://www.cadc-ccda.hia-ihia.nrc-cnrc.gc.ca/en/meetings/>
- 6 EuroPython Society discussion of online events: <https://www.europython-society.org/post/617463429296472064/sharing-our-research-and-licenses-for-going-online>
- 7 Mattermost open source collaboration platform: <https://mattermost.com>
- 8 Golden Webinars: <https://www.uc.cl/en/news/golden-webinars-in-astronomy>
- 9 ESO Cosmic Duologues: <https://www.eso.org/sci/meetings/garching/Cosmic-Duologues.html>
- 10 Conference reddit site: https://www.reddit.com/r/cosmology/comments/hdwjgp/eso_conference_h0_2020_assessing_uncertainties_in/

Fellows at ESO

Paulo A. Miles-Páez

Astronomy has captivated my attention since I was a child, just like many of my colleagues. I was born in La Serena (Chile), a town almost unknown to most of the world, but very popular amongst astronomers. The first time I saw a dark, deep sky was when I was four or five years old. It was during a visit to my great-grandparents, who lived in a small village in the mountains near the Argentinian border. I still remember the darkness of that sky and the large collection of stars that populated it, some of them so faint that I was not sure if they were real or just my eyes tricking me. After this, one of my hobbies was to watch the Moon and some areas of the sky with a pair of binoculars from my backyard every night. Local outreach activities also contributed to my passion for the night sky. During the mid-1990s a group of astronomers used to visit public schools in La Serena with a portable planetarium. I am not sure which astronomical association organised this project, but I am very grateful as this was the first time that somebody talked to me about the things that are going on in the sky. This fascinated me so much that I used to ask my parents to take me to other schools just to visit the planetarium again.

Unfortunately, in the 1990s doing astronomy in La Serena was considered an eccentric activity, mostly reserved to the American and European researchers who visited the town before heading to the observatories in the area. When I started to ask how to become an astronomer, the best option that I found was to move to Santiago and try there. In addition, I was always advised (at school!) to study something “more useful” and “practical” in order to secure a “good job”. In this regard, my parents and my little sister were crucial, as they always supported me and gave me the freedom to choose any path for my career.

In 2001 my quiet life in La Serena changed completely, as my family moved to Madrid (Spain). I was so surprised (and confused) the first time I saw the Orion constellation upside-down! In the following years I could not see very dark skies in the capital of Spain, but I did visit the planetarium in Madrid many times. After high school I

started to study physics at the Universidad Complutense de Madrid (UCM). The (old) Licentiate in Physics degree consisted of five years of study. Three of general physics, in which I got a taste of research work by doing a couple of summer projects in optics and solid state physics, and two final years of specialisation — when obviously I chose astrophysics. Thanks to the Bologna Process, my generation had to take an extra academic year to get the new MSc degrees before qualifying to start a PhD programme in Spain. This final year was mostly research-focused, so I investigated the activity properties of ultra-cool dwarfs in the infrared under the supervision of David Montes — as preparatory work for the Calar Alto high-Resolution search for M dwarfs with Exoearths with Near-infrared and optical Échelle Spectrographs (CARMENES) instrument. Apart from the study time, I also have very good memories of my days in the faculty playing cards with my colleagues — more than 10 years later, when we all are in Madrid we still meet each other to have some drinks and play again.

By the end of my degree, I had developed a particular interest in brown dwarfs and extrasolar planets, so I decided to start a PhD. This was possible in 2011 when I was offered the Astrofísico Residente fellowship at the Instituto de Astrofísica de Canarias (IAC) in Tenerife. Leaving my comfort zone in Madrid was not an easy decision, but I was resolved to perform my research at an observatory. For my PhD I worked with Enric Pallé and María Rosa Zapatero Osorio on the atmospheric characterisation of very low-mass stars and brown dwarfs using observations of linear polarisation. At the IAC I had the opportunity to interact with researchers interested in topics as diverse as solar physics, stellar evolution and cosmology (and everything in between). I also got a lot of observing experience at the observatories of Izaña (Tenerife) and Roque de los Muchachos (La Palma). Some of my favourite telescopes during my PhD were the IAC80, the Nordic Optical Telescope and the William Herschel Telescope (and obviously the FOCal Reducer and low dispersion Spectrograph 2 [FOR2] on the Very Large Telescope [VLT], too!). At the end of my thesis I had accumulated about 100 nights of observations, and



lots of hours using robotic telescopes from home.

After defending my PhD, I moved to the University of Western Ontario, Canada, to start my first postdoc in Stan Metchev's substellar objects team. There I continued my studies on substellar atmospheres by using photometric and spectroscopic observations with data from Gemini, Hubble, Spitzer, and some robotic telescopes from the Southeastern Association for Research in Astronomy (SARA) network. I also had the opportunity to observe at Kitt Peak National Observatory in Arizona (another privileged place to contemplate the night sky), and helped in the initial construction of the Colibri Telescope Array near London, Ontario, sometimes in winter at -20 degrees C! I am very thankful to my wife, who was crazy enough to join me on this adventure in North America, where our son was born. By the end of my postdoc in 2018, I was offered an ESO Fellowship in Munich. ESO is one of the key names that I heard as a child, and working there was a chance that I could not miss, so my little family and I switched continents again in September 2019.

In my research I try to understand the atmospheric structure and composition of substellar objects by using different techniques and instruments from several telescopes. This has made me realise the

importance of the (sometimes invisible) tasks that take place in an observatory — from the moment that a proposal is approved to the time when data are collected. Because of this I decided to do my functional work at the ESO User Support Department. I currently give support to programmes related to FORS2 and the Echelle SPectrograph for Rocky Exoplanet and Stable Spectroscopic Observations (ESPRESSO), and soon to the CRyogenic high-resolution InfraRed Echelle Spectrograph+ (CRIRES+), too. I enjoy checking the observational strategies that other astronomers send us for their programmes, and helping them when they get stuck in the elaboration of this material. My duties give me the chance to interact with our colleagues from Paranal, and to learn from them when they identify an observing run that can be optimised to maximise the science return. I am also involved in the preparatory work for the upgrade of FORS (FORS-Up), which allows me to learn about the initial phases in the design of an instrument. Apart from my duties, I am currently the Fellow mentor of four PhD students at ESO, and have participated in the organisation of the second and third ESO Summer Programmes; these have been extremely rewarding experiences.

During my free time I enjoy exploring the beautiful area of Bavaria with my family, that recently got bigger with the birth of my daughter, or visiting some very old buildings. Astronomy has set out the path that I have followed for my career, taking me to several countries, living lots of adventures and meeting people from different cultures. Every minute invested in learning about it has been worth it!

Nicola Pietro Gentile Fusillo

I was six years old when for the first time I looked through a telescope and observed the marks that the comet Shoemaker-Levy had left on Jupiter. I couldn't know it at the time, but the fascination I felt then, realising I was directly seeing events happening on another world, would never leave me.

When I was growing up astronomy became one of my passions and it drove my academic interest in physics. When I

was 16 I won a scholarship to attend the United World College of the Atlantic, a boarding school in Wales, so I moved from Italy to the UK. There I was very lucky to meet teachers who were passionate about their subjects and eager to foster the same passion in their students. I will forever be grateful to my physics teacher, Gabor Vincze, who recognised my interest in astronomy and helped me decide to apply to study physics at university.

I stayed in the UK and enrolled in the integrated Master's physics course at the University of Warwick where for my Master's I "mined" the database of rejected objects from the Wide Angle Search for Planets (WASP) looking for variable stars. This was my first real experience of a research environment in astronomy, and, despite its unique mix of frustration and excitement, it convinced me that I wanted to take my education further and apply for a PhD. I was offered the opportunity to stay at the University of Warwick and pursue a PhD with Boris Gänsicke on the topic of white dwarfs. Warwick became my second home and I dedicated myself to absorbing as much as I could from the amazing people who made up the astronomy group. I will never be able to thank Boris enough for all that he taught me as my PhD supervisor.

During my doctorate, I also took part in a one-year studentship in the Isaac Newton Group on the island of La Palma, where I worked as a support astronomer at the Isaac Newton Telescope (INT). The INT is a remarkable facility where most of the time one lone astronomer spends night after night running the 2.5-metre telescope completely on their own. Those were strange, but also somewhat magical, nights and the INT proved to be the perfect "school" for observational astronomy. I treasure every single day of my year in La Palma and the experience renewed my passion for astronomy. Back at Warwick I completed my PhD and almost immediately started a postdoc position in the same group under the leadership of Pier-Emmanuel Tremblay. I was given considerable freedom to pursue my own research interest and focused much of my work on constructing large samples of white dwarfs using the Gaia satellite and then using these white dwarfs as tools to explore the evolution of extra-



solar planetary systems. In my research I had the opportunity to use the ESO telescopes at Paranal Observatory in Chile and naturally became very interested in the international organisation behind these cutting-edge facilities. With a science focus in observational astronomy and my previous experience of large telescopes, I was soon drawn to the ESO Fellowship. I joined ESO in Garching as a fellow in 2019 and immediately felt welcome in the diverse social and scientific environment of this organisation. I had originally hoped that my functional work would be to support operations at Paranal, but after just my first trip to Chile the global pandemic made this duty option impossible. However, at ESO there is no lack of opportunities to take part in extremely interesting projects and in my new functional work I use my expertise in white dwarfs and large area surveys to find standard stars for the next-generation instruments that will be mounted on the ELT.

Despite the chaotic year we have just been through, ESO remains a unique place where I have found absolute freedom in my science objectives, an amazing and supportive group of peers, and an open international environment where in the space of one coffee break problems and doubts are answered with expertise and wild ideas can turn into successful projects.

Personnel Movements

Arrivals (1 July 2021–30 September 2021)

Europe	
Amiaux, Jérôme (FR)	Instrumentation Engineer/Physicist
Claes, Rik (BE)	Student
Langan, Ivanna (FR)	Student
Mandla, Christopher (DE)	Electronics Engineer
Reiter, Megan (US)	Fellow
Somigliana, Alice (IT)	Student
Thomson-Paessant, Keegan (FR/AU)	Student
Tutuntzisz, Tamas (HU)	IT Specialist – Infrastructure
van Marrewijk, Joshiwa (NL)	Student
Weng, Simon (AU)	Student

Chile

Beauchesne, Benjamin (FR)	Student
Frensch, Yolanda (NL)	Student
Behara, Natalie (FR)	Data Scientist
Labdon, Aaron (UK)	Fellow

Departures (1 July 2021–30 September 2021)

Europe	
Beuchert, Tobias (DE)	ESO Supernova Presenter
Cerpa Urrea, Nelly Natalia (CL)	Student
Davison, Thomas (UK)	Student
Erkal, Jessica (IE)	Student
Facchini, Stefano (IT)	Fellow
Fahrion, Katja (DE)	Student
Gil, Virginie (FR)	Administrative Assistant
Pala, Anna Francesca (IT)	Fellow
Petit dit de la Roche, Dominique (NL)	Student
Rombout, Francky (BE)	Payroll Officer
Sánchez Menguiano, Laura (ES)	Fellow
Stanke, Thomas (DE)	User Support Astronomer
Wallace, Jane (UK)	Council Secretary

Chile

Ahumada, Bernardo (CL)	Mechanical Section Supervisor
De Figueiredo Melo, Claudio (BR)	ESO Representative in Chile
Gran, Felipe (CL)	Student
Houllé, Mathis Gilles Vital (FR)	Student
Kakkad, Darshan (IN)	Fellow
Sedaghati, Elyar (IR)	Fellow

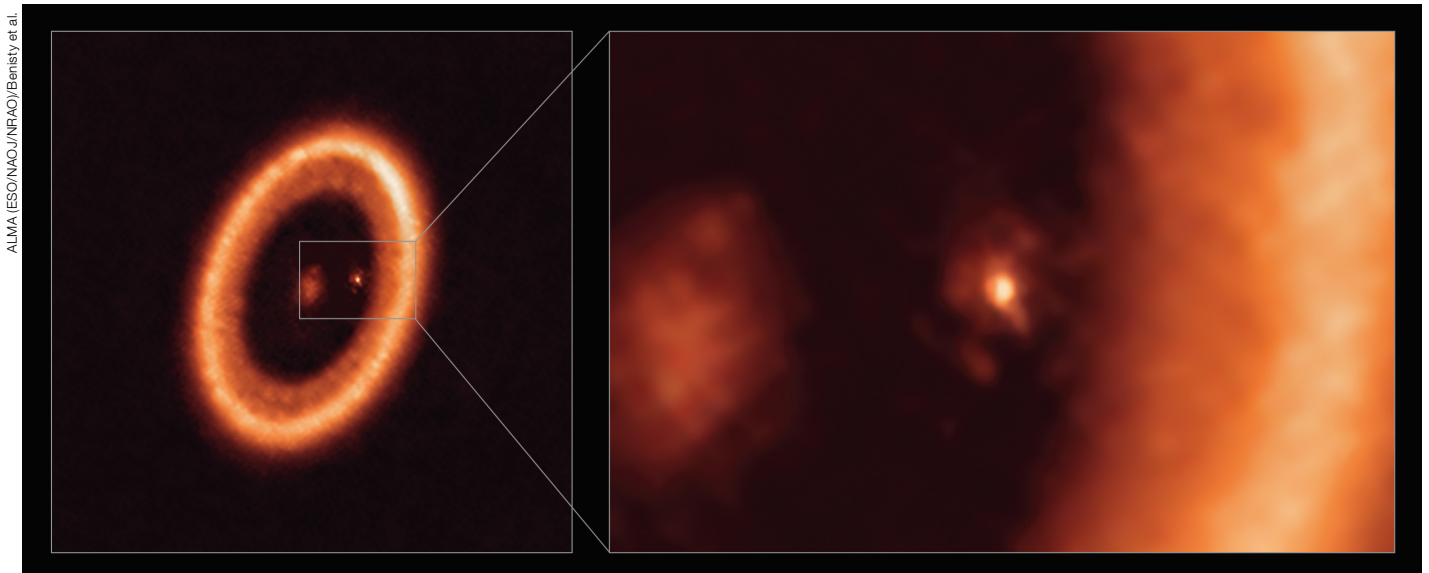

ALMA (ESO/NAOJ/NRAO)/Benisty et al.

This image, taken with the Atacama Large Millimeter/submillimeter Array (ALMA), shows wide (left) and close-up (right) views of the moon-forming disc surrounding PDS 70c, a young Jupiter-like planet nearly 400 light-years away. The close-up view shows PDS 70c and its circumplanetary disc centre-front, with the larger circumstellar ring-like disc taking up most of the right-hand side of the image. The star PDS 70 is at the centre of the wide-view image on the left (for more details see ESO press release eso2111).



Reach New Heights

Fellowships in Germany or Chile

Develop your scientific profile
Become an independent researcher
Prepare for future responsibilities



eso.org/fellowship
Deadline: 15 October 2021